

LOCTITE®

THE ADHESIVE SOURCEBOOK

2011 VOLUME 11



Your Source for
**LOCTITE® PRODUCTS FOR DESIGN,
ASSEMBLY, MANUFACTURING
AND MAINTENANCE**

Henkel

www.henkelna.com/industrial

THE ADHESIVE SOURCEBOOK



Your Source for **LOCTITE® PRODUCTS** FOR DESIGN, ASSEMBLY, MANUFACTURING AND MAINTENANCE

The Adhesive Sourcebook is the preferred choice for locating high-performance Loctite® adhesives, sealants, lubricants, coatings, dispensing and curing equipment for industrial manufacturing and maintenance repair.

The Adhesive Sourcebook contains over 1,500 products in total! Put them to work to make things better, faster and more cost-efficient. Loctite® products will help you tackle the most difficult challenges the world can throw your way.

THE ADHESIVE SOURCEBOOK 2011 HAS BEEN ENHANCED

Easier to use and easier to read
Check out some of the **NEW** features:

Sources **REVEALED**

In each section of the Adhesive Sourcebook, we reveal the typical application areas where Loctite® products are used, including the key industries and applications. Throughout the Adhesive Sourcebook, we've added even more application/industry photos that pinpoint the exact application areas for you.



EASY TO MATCH EQUIPMENT WITH **LOCTITE® PRODUCTS**



We've made it easier for you to match up the right equipment with the Loctite® product for your application. We also have added the related page number where complementary consumables and dispense accessories can be found.

e-CATALOG

The Adhesive Sourcebook is now also an online catalog where you can find quick links to products, equipment, Technical Data Sheets and Material Safety Data Sheets. Check it out on www.henkelna.com/loctite.



Source's **PICK**

Products marked as Source's Pick are products that have consistently demonstrated proven performance in handling a variety of customer applications, and are most often included in initial product testing and evaluation.

NEW

Products listed in red indicate New or Preferred Product.

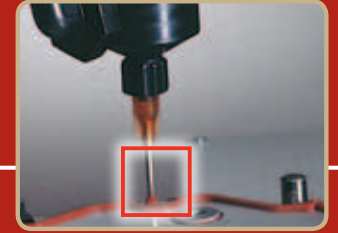
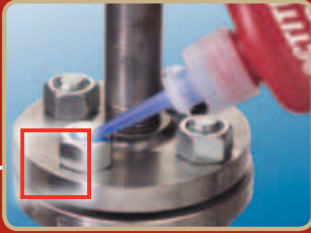

ADDITIONAL RESOURCES AVAILABLE

The Adhesive Sourcebook is supported by information over the phone and on the web.

[On the Phone]

1-800-LOCTITE (562-8483) – U.S.

1-800-263-5043 – Canada

Immediate technical assistance is available from 8 a.m. to 5 p.m. ET, Monday through Friday.

Technical Product Assistance

Application Assistance – Receive local application assistance from the Loctite® Adhesives and Sealants Specialist in your area.

Distributor Locator – Access the name of your nearest distributor authorized to sell Loctite® products.

Loctite® is the preferred choice for high-performance adhesive and sealant solutions for industrial manufacturing and maintenance.

LOCTITE®

[Website]

www.henkelna.com/loctite

In addition to support from your local representative, our website, www.henkelna.com/loctite, is your source for Loctite® distributors, safety and technical data sheets, literature and product application assistance. Here is a brief overview of what our website has to offer:

E-catalog – Gain quick and easy access to product descriptions, approvals/specifications, application suggestions, package specifications, and technical and material safety data.

Application Assistance – Application assistance aids in narrowing the range of products suitable for your design and maintenance needs. Or send a message to your local Adhesives and Sealants Specialist to arrange “in-person” assistance.

Distributor Locator – Find a local distributor in the U.S. or Canada that has the product you need. All it takes is a zip or postal code.

Data Sheets & Literature – Instant access to Technical Data Sheets and Material Safety Data Sheets. View electronic versions of our design guides, bonding guides, quick reference tools and other special literature.

What's New? – Find out about new Loctite® product introductions, feature articles, trade show schedules and application success stories. Register online for adhesives seminars or CEU-accredited Manufacturing Reliability Training classes in your area.

STRAIGHT FROM *The Source*

THE ADHESIVE SOURCEBOOK

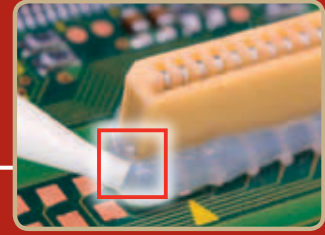

Your Source for
LOCTITE® PRODUCTS
FOR DESIGN, ASSEMBLY,
MANUFACTURING AND MAINTENANCE

At Henkel Corporation, we invent more than just quality Loctite® products, we provide solutions to industry's biggest challenges. Whether we are reducing assembly cost, providing design and application assistance, or increasing the reliability of your process, Henkel is dedicated to earning and keeping the trust of its customers. Through this philosophy, Henkel has assumed a position of worldwide leadership.

Trust **Henkel** to be **Your Source** for Design Assistance, Application Assistance and After-the-Sale Support.

[Table of Contents]

THE ADHESIVE SOURCEBOOK INTRODUCTION	1
TABLE OF CONTENTS	3
BONDING	5
CYANOACRYLATES	7
CYANOACRYLATE EQUIPMENT	11
HOT MELTS	13
HOT MELTS EQUIPMENT	17
LIGHT CURE ADHESIVES	19
LIGHT CURE ADHESIVES EQUIPMENT	23
ELASTOMERIC ADHESIVES & SEALANTS	27

ELASTOMERIC EQUIPMENT	28
SOLVENT-BASED ADHESIVES	29
MAGNET BONDING STRUCTURAL ADHESIVES	31
MAGNET BONDING EQUIPMENT	34
METAL BONDING STRUCTURAL ADHESIVES	35
METAL BONDING EQUIPMENT	38
MULTIPLE SURFACE BONDING STRUCTURAL ADHESIVES	39
PLASTIC/COMPOSITE BONDING STRUCTURAL ADHESIVES	45
PLASTIC/COMPOSITE BONDING EQUIPMENT	49
COATINGS	51
PROTECTIVE COATINGS	55
WEAR-RESISTANT COATINGS	57
FLOORING & CONCRETE REPAIR	61
ANTI-SLIP COATINGS	65
FLOOR SEALANTS & TOPCOATS	67
FLOORING, CONCRETE REPAIR & GROUTING	69
GASKETING & SEALING	73
ANAEROBICS	75
ANAEROBIC EQUIPMENT	78
ELASTOMERIC ADHESIVES & SEALANTS	79
ELASTOMERIC EQUIPMENT	80
SILICONE ADHESIVES & SEALANTS	81
SILICONE ADHESIVE & SEALANTS EQUIPMENT	88
WINDSHIELD GLASS INSTALLATION	89
LUBRICATING	91
ANTI-SEIZE	93
LUBRICANTS	97

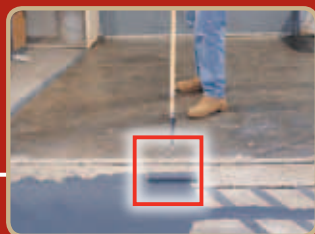

MACHINING COMPOUNDS	101	MEDICAL CURING EQUIPMENT	167
ABRADING COMPOUNDS	103	MEDICAL DISPENSING EQUIPMENT	169
POTTING & ENCAPSULATING	105	EQUIPMENT	171
EPOXIES & POLYURETHANES	107	CONTROLLERS & RESERVOIRS	173
SILICONES	111	LIGHT CURING EQUIPMENT	173
SILICONE EQUIPMENT	113	HANDHELD APPLICATORS	174
HOT MELTS	114	HANDHELD VALVES	174
HOT MELTS EQUIPMENT	115	DISPENSE SYSTEMS	174
REPAIRING, REBUILDING & RESTORING	117	VALVES & PUMPS	175
BELT REPAIRS & URETHANES	119	TWO-PART VOLUMETRIC DISPENSING	175
MAINTENANCE & REPAIR EPOXIES	121	HOT MELTS EQUIPMENT	176
RETAINING	125	MOTION CONTROL ROBOT DISPENSE SYSTEM	176
RETAINING COMPOUNDS	127	CONSUMABLES – DISPENSE ACCESSORIES	176
RETAINING COMPOUNDS EQUIPMENT	131	MOTION CONTROL ROBOT	
SURFACE PREPARATION	133	DISPENSE SYSTEM	177
CLEANERS & DEGREASERS	135	TWO-PART VOLUMETRIC DISPENSING	
PRIMERS, ACTIVATORS & ACCELERATORS	139	LOCTITE® POSI-LINK™ DISPENSE	
THREADLOCKING	141	SYSTEM FOR DUAL CARTRIDGES	179
THREADLOCKERS	143	METER MIX SYSTEMS	181
THREAD SEALING	149	CONSUMABLES –	
THREAD SEALANTS	151	DISPENSE ACCESSORIES	182
THREADLOCKING & THREAD SEALING	155	AGENCY LISTINGS	187
THREADLOCKERS &		FAQs	189
THREAD SEALANTS EQUIPMENT	155	ENGINEERING SERVICES	191
TOOLBOXES & SPECIALTY KITS	157	OEM TRAINING SERVICES	193
MEDICAL APPLICATION SOLUTIONS	159	MRO TRAINING SERVICES	194
LIGHT CURE ACRYLIC ADHESIVES	161	OBSOLETE PART NUMBER LISTING	195
CYANOACRYLATES, ACCELERATORS & PRIMERS	163	INDEX	197
EPOXIES, SILICONES & URETHANES	165		

LOCTITE®

Your Source for **BONDING**



[Table of Contents]

BONDING	5
CYANOACRYLATES	7
CYANOACRYLATE EQUIPMENT	11
HOT MELTS	13
HOT MELTS EQUIPMENT	17
LIGHT CURE ADHESIVES	19
LIGHT CURE ADHESIVES EQUIPMENT	23
ELASTOMERIC ADHESIVES & SEALANTS	27
ELASTOMERIC EQUIPMENT	28
SOLVENT-BASED ADHESIVES	29
MAGNET BONDING STRUCTURAL ADHESIVES	31
MAGNET BONDING EQUIPMENT	34
METAL BONDING STRUCTURAL ADHESIVES	35
METAL BONDING EQUIPMENT	38
MULTIPLE SURFACE BONDING STRUCTURAL ADHESIVES	39
PLASTIC/COMPOSITE BONDING STRUCTURAL ADHESIVES	45
PLASTIC/COMPOSITE BONDING EQUIPMENT	49

For successful bonding, knowledge of adhesive methodology is essential. The most frequent causes for adhesive failure do not involve adhesive strength. Rather, they are attributed to inadequate preparation of the substrates and improper adhesive selection. The most important factor in proper adhesive selection is assessing the environment the adhesive must withstand. Once the environmental factors have been recognized, adhesive selection becomes more easily defined as other factors, such as joint design, substrates, load, stress cycles, etc., can often be varied or altered with minor design changes.

WHAT IS THE BEST ADHESIVE FOR MY APPLICATION?

The following chart has been designed to help you select a bonding adhesive. This chart is intended to serve as a general guideline to help you determine which adhesive categories are best suited for your application. The data presented represents typical properties for each adhesive category; however, individual product properties may differ. It is suggested that, based on the information provided, you consider at least the two best adhesive categories that meet your application criteria. Individual product information can then be found on the pages that follow to help narrow your search.

FREE BONDING GUIDES

Loctite® Design Guides help you select the proper Loctite® adhesive for bonding Metals, Plastics, Rubbers and Thermoplastic Elastomers. Visit www.henkelna.com/loctite and click on **Literature**, then select **Bonding** to view the guides or request copies.



ADDITIONAL RESOURCES

Loctite® Adhesives and Sealants Product Specialists are available to assist you with new product designs, or to help you re-engineer an existing application for improved performance and cost savings. They can also set up testing of your parts at the Henkel Customer Engineering Center. For application assistance, call **1-800-LOCTITE (562-8483)**; *within Canada, call 1-800-263-5043*; or, contact us through the web at www.henkelna.com/loctite.

STRAIGHT FROM *The Source*

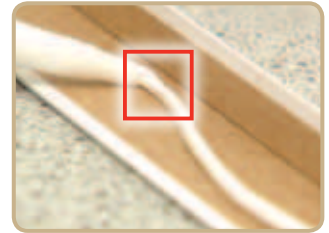
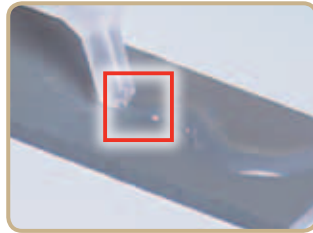

Your Source BONDING GUIDE

PERFORMANCE CONSIDERATIONS	ADHESIVE CATEGORY								
	CYANOACRYLATES	EPOXIES	HOT MELTS	LIGHT CURE	SILICONES	ELASTOMERS	URETHANES	2-PART ACRYLICS	2-STEP ACRYLICS
BENEFITS	Wide range of bonding applications / ease of use	Wide range of formulations	Versatile, fast, large gap filling	Rapid cure/adhesion to plastics	Excellent temperature resistance	Flexible, paintable, bonder/sealant	Excellent toughness/flexibility	Good impact resistance/flexibility	Good impact resistance/no-mix
LIMITATIONS	Low solvent resistance / ease of use	Mixing required	Limited heat resistance	Light cure required	Low adhesion resistance	High temperature resistance	Sensitive to moisture	Mixing required	Primer required
TEMPERATURE RESISTANCE									
Typical for the category	-65°F to 180°F (-54°C to 82°C)	-65°F to 180°F (-54°C to 82°C)	-65°F to 250°F (-54°C to 121°C)	-65°F to 300°F (-54°C to 149°C)	-65°F to 400°F (-54°C to 204°C)	-65°F to 200°F (-54°C to 93°C)	-65°F to 250°F (-54°C to 121°C)	-65°F to 250°F (-54°C to 121°C)	-65°F to 300°F (-54°C to 149°C)
Highest rated product	+250°F (121°C)	400°F (204°C)	330°F (166°C)	350°F (121°C)	725°F (385°C)	200°F (93°C)	300°F (149°C)	250°F (121°C)	400°F (204°C)
ENVIRONMENTAL RESISTANCE									
Polar Solvents (EX.: H ₂ O, ETHYLENE GLYCOL, ISOPROPYL ALCOHOL (IPA), ACETONE)	Poor ¹	Very Good	Good	Good	Good	Good	Good	Good	Good
Non-Polar Solvents (EX. MOTOR OIL, TOLUENE, GASOLINE, ATF)	Good	Excellent	Good	Very Good	Poor to Fair	Poor	Good	Very Good	Very Good
ADHESION TO SUBSTRATES									
Metals	Very Good	Excellent	Good	Good	Good	Very Good	Good	Excellent	Excellent
Plastics ²	Excellent	Fair	Very Good	Excellent	Fair	Good	Very Good	Excellent	Fair
Glass	Poor	Excellent	Good	Excellent	Very Good	Good	Good	Good	Excellent
Rubber	Very Good	Fair	Fair	Fair	Good	Poor	Good	Poor	Poor
Wood	Good	Very Good	Excellent	Poor	Fair	Very Good	Fair	Good	Good
OVERLAPPING SHEAR STRENGTH	High	High	Low	High	Low	Medium	Medium	High	High
PEEL STRENGTH	Low ⁵	Medium	Medium	Medium	Medium	Medium	Medium	High	Medium
TENSILE STRENGTH	High	High	Low	High	Medium	Medium	Medium	High	High
ELONGATION/FLEXIBILITY	Low	Low	High	Medium	High	High	High	Medium	Medium
HARDNESS	Rigid	Rigid	Semi-Soft	Semi-Rigid	Soft	Soft	Soft	Semi-Rigid	Semi-Rigid
PROCESS CONSIDERATIONS	ADHESIVE CATEGORY								
	CYANOACRYLATES	EPOXIES	HOT MELTS	LIGHT CURE	SILICONES	ELASTOMERS	URETHANES	2-PART ACRYLICS	2-STEP ACRYLICS
NUMBER OF COMPONENTS	1	2	1	1	1	1	2	2	2
CURE TEMPERATURE	Room Temperature	Room Temperature	Room Temperature ³	UV/Visible	Room Temperature	Room Temperature	Room Temperature	Room Temperature	Room Temperature
FIXTURE TIME									
Average	40 seconds	20 minutes	70 seconds	30 seconds	25 minutes	25 minutes	25 minutes	20 minutes	5 minutes
Fastest	< 5 seconds	3 to 5 minutes	20 seconds	5 seconds	2 minutes	10 minutes	5 minutes	3 to 5 minutes	30 seconds
FULL CURE TIME	24 hours	12 to 24 hours	1 hour (or when cooled) ⁴	30 to 60 seconds	1 to 7 days	1 to 7 days	24 hours	24 hours	24 hours
GAP FILL									
Ideal (in inches)	0.001 to 0.010	0.004 to 0.006	0.002 to 0.005	0.002 to 0.010	0.001 to 0.006	0.001 to 0.006	0.004 to 0.006	0.010 to 0.040	0.002 to 0.004
Maximum (in inches)	0.080	0.125	0.240	0.25	0.25	0.24	0.125	0.5	0.040
DISPENSING/MIXING EQUIPMENT REQUIRED	NO	YES	YES	NO	NO	NO	YES	YES	NO
LIGHT CURE VERSIONS AVAILABLE	YES	YES	NO	YES	YES	NO	NO	NO	YES

¹ Cyanoacrylates have very good moisture resistance on plastics.

² Uncured liquid adhesives may cause stress cracking of certain thermoplastics, e.g., polycarbonate, acrylic and polysulfone. Special products and process techniques are available. Consult the Loctite® Design Guide to Bonding Plastics (LT-2197) or contact 1-800-LOCTITE (562-8483) for more information.

³ Elevated temperatures are required to dispense liquid Hot Melt Adhesives.

⁴ Urethane Hot Melts require 24 hours for full cure.

⁵ Exception: Toughened cyanoacrylates have HIGH peel strength.

PLEASE NOTE: This chart should not be used to specify products without specific testing. It is recommended that you conduct on-part testing to ensure product performance before specifying any adhesive.

Your Source for BONDING CYANOACRYLATES



- Widest selection of high-performance, application-specific, instant adhesives
- Available in a variety of viscosities, cure speeds, gap-filling capabilities and substrate compatibilities
- Ultra-high-performance Loctite® Prism® family offers toughened formulations, low odor, low blooming and thermally resistant formulations

[General-Purpose / Surface Insensitive]

Source's PICK Loctite® 401™ Prism® Instant Adhesive

LOW/MEDIUM VISCOSITY

Designed for the assembly of difficult-to-bond materials that require uniform stress distribution. Particularly suited for bonding a wide range of materials, including metals, plastics and elastomers. Also formulated for faster cure speeds on dry or acidic surfaces and substrates.

Item #	40104	3 g tube
	40140	20 g bottle
	40161	1 lb. bottle

Loctite® 406™ Prism® Instant Adhesive

WICKING GRADE

Designed for the bonding of plastics and elastomeric materials where very fast fixturing is required.

Item #	40604	3 g tube
	40640	20 g bottle
	40661	1 lb. bottle

Source's PICK Loctite® 431™ Prism® Instant Adhesive

MEDIUM VISCOSITY

For bonds that require greater gap fill. Bonds to a wide variety of substrates, including dry or acidic surfaces. Fixtures fast and stays fast throughout the life of the product.

Item #	41254	3 g tube
	41255	20 g bottle
	41256	1 lb. bottle

Loctite® 411™ Prism® Instant Adhesive

CLEAR

Designed for applications requiring greater gap fill and added peel strength.

Item #	41104	3 g tube
	41145	20 g bottle
	41161	1 lb. bottle

Source's PICK Loctite® 454™ Prism® Instant Adhesive

GEL

Designed for the assembly of difficult-to-bond materials that require uniform stress distribution. Particularly suited for bonding porous or absorbent materials. Also formulated for faster cure speeds on dry or acidic surfaces and substrates.

Item #	45404	3 g tube
	21925	10 g syringe
	45440	20 g tube
	45474	200 g tube
	45478	300 g cartridge

[Low Odor / Low Bloom]

Loctite® 403™ Prism® Instant Adhesive

HIGH VISCOSITY

Part of a family of low-odor, low-blooming, surface-insensitive products designed to improve both the work environment and the cosmetic appearance. Products now have faster fixture speeds on plastics and metals.

Item #	40304	3 g tube
	40340	20 g bottle
	40361	1 lb. bottle

Loctite® 455™ Prism® Instant Adhesive

GEL

Particularly suited for bonding porous or absorbent substrates where low odor and/or non-blooming properties are required.

Item #	22309	10 g syringe
	17421	200 g tube

[Toughened]

Loctite® 380™ Black Max® Instant Adhesive

The original elastomer-modified instant adhesive. Bonds metal, rubber and plastic. Excellent peel, impact and shear strength.

Item #	38004	3 g tube
	38050	20 g bottle
	38061	1 lb. bottle

Loctite® 426™ Prism® Instant Adhesive

GEL

Designed for porous surfaces and vertical or overhead applications with the added benefits provided by an elastomer-modified instant adhesive.

Item #	21921	10 g syringe
	18398	20 g tube
	17451	200 g tube
	17529	300 g cartridge

[High Gap]

Loctite® 3092™ Instant Adhesive

GEL

Fast 2-part product bonds gaps up to 0.080 in. (2 mm). Particularly suited for bonding, plastics, rubbers, wood, paper, leather or metals.

Item #	1321706	10 g syringe with 3 mix nozzles
--------	---------	---------------------------------



[Applications]

- Synthetic rubber feet to ABS housing
- Absorbing material to steel sheet
- Safety rubber pads to aluminum ladder steps
- PVC to paper for packaging materials
- Aluminum potentiometer scale to painted steel control box
- Braided sleeve to rubber heater hose
- Plastic housing base to fire extinguisher bottle
- Small bearings into plastic/metal housings
- Tacking strain gauges in position
- Abrasive tips to machine tools
- PVC tube to ABS connector
- PC windows to ABS housing
- Logos and plastic parts in the cosmetic industry
- Polyurethane foam to PVC plastics
- Wide variety of medical devices including flexible tubing/balloons
- Rubber tire to ABS wheel on model car
- Rubber tube to rubber fitting
- Ferrite magnets to plastic and metal housing
- Loudspeaker parts
- Tacking O-rings in metal-grooved enclosures
- ABS inner part on wooden body of a fountain pen
- Clear plastic display systems
- Housing components of electrical appliances
- Flexible rubber profile to painted steel refrigerator door
- Flexible gaskets and seals
- Aluminum to EPDM
- Steel to epoxy composite
- Rubber-to-rubber
- Rubber to metal gaskets
- Metal-to-metal
- Plastic-to-plastic
- Rubber seals
- E-cores
- Steel cover plates in transformers
- Electric motors
- Disk drives
- Connector plug in stainless steel sensor housing

Source's PICK

Loctite® 435™ Prism® Instant Adhesive

SURFACE INSENSITIVE

The first true clear, surface insensitive, elastomer-modified instant adhesive. Faster fixture times over traditional toughened adhesives with exceptional bond and peel strength on metals, plastics and rubbers.

Item #	41005	3 g tube
	40994	20 g bottle
	40995	1 lb. bottle

[Light Cure Adhesive]

Source's PICK

Loctite® 4306™ Flashcure® Light Cure Adhesives

Wicking grade fluorescent adhesive that achieves tack-free cure in less than 5 seconds. Surface versatile with shadow cure capability.

Item #	4306™	37439	1 oz. bottle
	4306™	37442*	1 lb. bottle

[General-Purpose]

Loctite® 382™ Tak Pak® Instant Adhesive

An adhesive designed for high performance wire tacking when used with Loctite® 712™ or 7452™ Tak Pak® Accelerator and for gap filling up to 0.008 in. (0.020 cm).

Item #	38203	3 g tube	Item #	38240	20 g bottle
	20420	20 g kit†		38261	1 lb. bottle

Source's PICK

Loctite® 480™ Prism® Instant Adhesive

Low viscosity, elastomer-modified instant adhesive. Bonds metals and rubbers. Excellent peel, impact and shear strength. NSF®/ANSI 61 certified for potable water.

Item #	48040	20 g bottle
	48061	1 lb. bottle

[Flexible]

Loctite® 4851™ / 4861™ Prism® Instant Adhesives

Medium and high viscosity instant adhesives for the assembly of flexible components.

Item #	4851™	37732	20 g bottle
	4851™	37733	1 lb. bottle
	4861™	37708	20 g bottle
	4861™	37711	1 lb. bottle

Source's PICK

Loctite® 404™ Quick Set™ Instant Adhesive

For general maintenance and repair. Excellent for rubber bonding.

Item #	46551	1/3 oz. bottle
	46548	4 oz. bottle
	46561	1 lb. bottle

[Toughened Thermally Resistant]

Loctite® 4203™ / 4204™ / 4204™ Prism® Instant Adhesive

Clear, toughened, thermally resistant instant adhesive. Excellent hot strength and heat aging properties up to 250°F.

Item #	4203™	1376970	20 g bottle
	4203™	28027	1 lb. bottle
	4204™	1376969	20 g bottle
	4204™	26325	1 lb. bottle
	4205™	28028	20 g tube
	4205™	28029	200 g tube
	4205™	28030	300 g cartridge

[Toughened Light Cure Adhesive]

Source's PICK

Loctite® 4310™ / 4311™ Flashcure® Light Cure Adhesives

Toughened fluorescent adhesives that cure tack-free extremely fast (2-5 seconds). Surface versatile with shadow cure capability.

Item #	4310™	1401792	1 oz. bottle
	4310™	1401790	1 lb. bottle
	4311™	1401791	1 oz. bottle
	4311™	1401789	1 lb. bottle

Loctite® 444™ Tak Pak® Instant Adhesive

An adhesive designed for printed circuit board assembly and repair. Cures instantly with Loctite® 712™ or 7452™ Tak Pak® Accelerator.

Item #	12292	20 g bottle
	20419	20 g kit†
	12294	1 lb. bottle

Loctite® 498™ Super Bonder® Instant Adhesive

THERMAL CYCLING RESISTANT

A medium viscosity, high temperature product for all metals and most plastics and rubbers. Resists temperatures to 180°F continuous or up to 250°F intermittent.

Item #	49850	1 oz. bottle
	49861	1 lb. bottle

* Grit-blasted steel.

† Contains Loctite® 382™ Tak Pak® Instant Adhesive (20 g bottle), Loctite® 7452™ Tak Pak® Accelerator (0.7 oz. net wt. aerosol can).

‡ Contains Loctite® 444™ Tak Pak® Instant Adhesive (20 g bottle), Loctite® 7452™ Tak Pak® Accelerator (1.75 fl. oz. liquid brush-top bottle).

Your Source for **BONDING**
CYANOACRYLATES



[Loctite® Instant Adhesives Properties Chart]

	LOCTITE® PRODUCT	ITEM NUMBER	PACKAGE TYPE/SIZE	TYPICAL USE	COLOR	GAP FILL (INCHES)	CATEGORY	VISCOSITY (cP)	SHEAR STRENGTH* (psi)	TEMPERATURE RANGE	CURE SPEED**	SPECIFIC GRAVITY	AGENCY APPROVALS
GENERAL-PURPOSE SURFACE INSENSITIVE	401™ PRISM®	40104 40140 40161	3 g tube 20 g bottle 1 lb. bottle	General- purpose	Clear	0.005	Ethyl	110	3,200	-65°F (-54°C) to 180°F (82°C)	Fixture – 15 sec. Full – 24 hrs.	1.05	CFIA
	406™ PRISM®	40604 40640 40661	3 g tube 20 g bottle 1 lb. bottle	Wicking grade	Clear	0.004	Ethyl	20	3,200	-65°F (-54°C) to 180°F (82°C)	Fixture – 15 sec. Full – 24 hrs.	1.05	N/A
	431™ PRISM®	41254 41255 41256	3 g tube 20 g bottle 1 lb. bottle	Gap filling	Clear	0.008	Ethyl	1,000	2,300	-65°F (-54°C) to 180°F (82°C)	Fixture – 15 sec. Full – 24 hrs.	1.10	ISO® 10993
	454™ PRISM®	45404 45440 1337712 45474 45478	3 g tube 20 g tube 30 g syringe 200 g tube 300 g cartridge	Porous surfaces	Clear	0.010	Ethyl	Gel	3,200	-65°F (-54°C) to 180°F (82°C)	Fixture – 15 sec. Full – 24 hrs.	1.05	CFIA, ABS
LOW ODOR / LOW BLOOM SURFACE INSENSITIVE	455™ PRISM®	22309 17421	10 g syringe 200 g tube	Porous surfaces	Clear	0.010	Alkoxy	Gel	2,600	-65°F (-54°C) to 160°F (71°C)	Fixture – 40 sec. Full – 24 hrs.	1.10	N/A
	403™ PRISM®	40304 40340 40361	3 g tube 20 g bottle 1 lb. bottle	Gap filling	Clear	0.008	Alkoxy	1,000	2,600	-65°F (-54°C) to 160°F (71°C)	Fixture – 50 sec. Full – 24 hrs.	1.10	N/A
	408™ PRISM®	40840 40861	20 g bottle 1 lb. bottle	Wicking grade	Clear	0.002	Alkoxy	5	2,600	-65°F (-54°C) to 160°F (71°C)	Fixture – 50 sec. Full – 24 hrs.	1.05	N/A
	460™ PRISM®	46004 46040 46061	3 g tube 20 g bottle 1 lb. bottle	Close- fitting parts	Clear	0.004	Alkoxy	45	2,600	-65°F (-54°C) to 160°F (71°C)	Fixture – 50 sec. Full – 24 hrs.	1.10	N/A
TOUGHENED SURFACE INSENSITIVE	380™ BLACK MAX®	38004 38050 38061	3 g tube 1 oz. bottle 1 lb. bottle	Close- fitting parts	Black	0.006	Ethyl	300	3,750	-65°F (-54°C) to 225°F (107°C)	Fixture – 90 sec. Full – 24 hrs.	1.10	CFIA
	410™ PRISM®	41004 41045 41061	3 g tube 20 g bottle 1 lb. bottle	Gap filling	Black	0.008	Ethyl	3,500	3,200	-65°F (-54°C) to 225°F (107°C)	Fixture – 90 sec. Full – 24 hrs.	1.07	CFIA
	426™ PRISM®	21921 18398 17451 17529	10 g syringe 20 g tube 200 g tube 300 g cartridge	Porous surfaces	Black	0.010	Ethyl	Gel	3,000	-65°F (-54°C) to 210°F (99°C)	Fixture – 20 sec. Full – 24 hrs.	1.10	N/A
	480™ PRISM®	48040 48061	20 g bottle 1 lb. bottle	General filling	Black	0.006	Ethyl	200	3,800	-65°F (-54°C) to 180°F (82°C)	Fixture – 90 sec. Full – 24 hrs.	1.10	NSF® / ANSI 61
	411™ PRISM®	41104 41145 41161	3 g tube 20 g bottle 1 lb. bottle	Gap filling	Clear	0.008	Ethyl	5,000	3,200	-65°F (-54°C) to 210°F (99°C)	Fixture – 30 sec. Full – 24 hrs.	1.07	N/A
	435™ PRISM®	41005 40994 40995	3 g tube 20 g bottle 1 lb. bottle	General- purpose	Clear	0.006	Ethyl	200	2,700	-65°F (-54°C) to 225°F (107°C)	Fixture – 30 sec. Full – 24 hrs.	1.10	ISO® 10993
	438™ PRISM®	41006 40997 40996	3 g tube 20 g bottle 1 lb. bottle	General- purpose	Black	0.006	Ethyl	200	2,800	-65°F (-54°C) to 225°F (107°C)	Fixture – 30 sec. Full – 24 hrs.	1.10	N/A
TOUGHENED THERMALLY RESISTANT	4203™ PRISM®	1376970 28027	20 g bottle 1 lb. bottle	Close- fitting parts	Clear	0.005	Ethyl	375	2,200	-65°F (-54°C) to 250°F (121°C)	Fixture – 40 sec. Full – 24 hrs.	1.10	N/A
	4204™ PRISM®	1376969 26325	20 g bottle 1 lb. bottle	Gap filling	Clear	0.008	Ethyl	4,000	2,400	-65°F (-54°C) to 250°F (121°C)	Fixture – 75 sec. Full – 24 hrs.	1.10	N/A
	4205™ PRISM®	28028 28029 28030	20 g tube 200 g tube 300 g cartridge	Porous surfaces	Clear	0.010	Ethyl	Gel	2,300	-65°F (-54°C) to 250°F (121°C)	Fixture – 90 sec. Full – 24 hrs.	1.10	N/A
LIGHT CURE TOUGHENED	4306™ FLASHCURE®	37439 37442*	1 oz. bottle 1 lb. bottle	Close fitting parts	Clear/Pale Green	0.004	Ethyl	20	2,000 [†]	-65°F (-54°C) to 180°F (82°C)	Fixture <5 sec [†] .	1.10	ISO® 10993
	4310™ FLASHCURE®	1401792 1401790	1 oz. bottle 1 lb. bottle	Close fitting parts	Clear/Pale Green	0.004	Ethyl	150	2,000 [†]	-65°F (-54°C) to 240°F (116°C)	Fixture <5 sec [†] .	1.05	ISO® 10993
	4311™ FLASHCURE®	1401791 1401789	1 oz. bottle 1 lb. bottle	Gap filling	Clear/Pale Green	0.008	Ethyl	900	2,000 [†]	-65°F (-54°C) to 240°F (116°C)	Fixture <5 sec [†] .	1.15	ISO® 10993
FLEXIBLE	4851™ PRISM®	37732 37733	20 g bottle 1 lb. bottle	Flexible	Clear	0.006	Alkyl	400	2,175	-65°F (-54°C) to 125°F (52°C)	Fixture – 20 sec. Full – 24 hrs.	1.10	ISO® 10993
	4861™ PRISM®	37708 37711	20 g bottle 1 lb. bottle	Flexible	Clear	0.008	Alkyl	4,000	2,465	-65°F (-54°C) to 125°F (52°C)	Fixture – 20 sec. Full – 24 hrs.	1.10	ISO® 10993

[Loctite® Instant Adhesives Properties Chart]

LOCTITE® PRODUCT	ITEM NUMBER	PACKAGE TYPE/SIZE	TYPICAL USE	COLOR	GAP FILL (INCHES)	CATEGORY	VISCOSITY (cP)	SHEAR STRENGTH* (psi)	TEMPERATURE RANGE	CURE SPEED**	SPECIFIC GRAVITY	AGENCY APPROVALS
382™ TAK PAK®	38203 20420 38240 38261	3 g tube 20 g kit† 20 g bottle 1 lb. bottle	Gap filling and ultra-performance wire tracking	Clear	0.008	Ethyl	5,000	3,200	-65°F (-54°C) to 210°F (99°C)	Fixture – 30 sec. Full – 24 hrs.	1.05	N/A
404™ QUICK SET™	46551 46548 46561	1/3 oz. bottle 4 oz. bottle 1 lb. bottle	Rubber O-ring bonder	Clear	0.005	Ethyl	80	3,500	-65°F (-54°C) to 180°F (82°C)	Fixture – 30 sec. Full – 24 hrs.	1.09	ABS, CFIA, Commercial item std. A-A-3097
409™ SUPER BONDER®	40904 21922 40945 40974 18030	3 g tube 10 g syringe 20 g tube 200 g tube 300 g cartridge	General-purpose gel	Clear	0.010	Ethyl	Gel	3,200	-65°F (-54°C) to 180°F (82°C)	Fixture – 75 sec. Full – 24 hrs.	1.10	N/A
414™ SUPER BONDER®	41404 41450 41461	3 g tube 1 oz. bottle 1 lb. bottle	Plastic bonder	Clear	0.006	Ethyl	110	3,200	-65°F (-54°C) to 180°F (82°C)	Fixture – 20 sec. Full – 24 hrs.	1.05	CFIA, Commercial item std. A-A-3097
415™ SUPER BONDER®	41550 41561	1 oz. bottle 1 lb. bottle	Gap filling metal bonder	Clear	0.008	Methyl	1,500	3,600	-65°F (-54°C) to 180°F (82°C)	Fixture – 30 sec. Full – 24 hrs.	1.09	Commercial item std. A-A-3097
416™ SUPER BONDER®	41650 41661	1 oz. bottle 1 lb. bottle	Gap filling plastic bonder	Clear	0.008	Ethyl	1,500	3,200	-65°F (-54°C) to 180°F (82°C)	Fixture – 30 sec. Full – 24 hrs.	1.05	CFIA, Commercial item std. A-A-3097
420™ SUPER BONDER®	42050 42061	1 oz. bottle 1 lb. bottle	Wicking type plastic bonder	Clear	0.002	Ethyl	2	2,900	-65°F (-54°C) to 180°F (82°C)	Fixture – 20 sec. Full – 24 hrs.	1.05	Commercial item std. A-A-3097
422™ SUPER BONDER®	42250 42261	1 oz. bottle 1 lb. bottle	Gap filling plastic bonder	Clear	0.008	Ethyl	2,500	3,200	-65°F (-54°C) to 180°F (82°C)	Fixture – 30 sec. Full – 24 hrs.	1.09	CFIA, Commercial item std. A-A-3097
430™ SUPER BONDER®	43004 43050 43061	3 g tube 1 oz. bottle 1 lb. bottle	Metal bonder for close-fitting parts	Clear	0.005	Methyl	80	3,600	-65°F (-54°C) to 180°F (82°C)	Fixture – 30 sec. Full – 24 hrs.	1.09	Commercial item std. A-A-3097
444™ TAK PAK®	12292 20419 12294	20 g bottle 20 g kit† 1 lb. bottle	Tak Pak® wire tacking	Clear	0.007	Ethyl	700	3,200	-65°F (-54°C) to 180°F (82°C)	Fixture – 30 sec. Full – 24 hrs.	1.05	Commercial item std. A-A-3097
493™ SUPER BONDER®	49350 49361	1 oz. bottle 1 lb. bottle	Wicking type metal bonder	Clear	0.002	Methyl	2	3,600	-65°F (-54°C) to 180°F (82°C)	Fixture – 30 sec. Full – 24 hrs.	1.09	Commercial item std. A-A-3097
495™ SUPER BONDER®	49504 49550 49561	3 g tube 1 oz. bottle 1 lb. bottle	General-purpose	Clear	0.004	Ethyl	45	2,750	-65°F (-54°C) to 180°F (82°C)	Fixture – 20 sec. Full – 24 hrs.	1.05	Commercial item std. A-A-3097, ABS
496™ SUPER BONDER®	49650 49661	1 oz. bottle 1 lb. bottle	General-purpose rubber bonder	Clear	0.005	Methyl	125	3,600	-65°F (-54°C) to 180°F (82°C)	Fixture – 30 sec. Full – 24 hrs.	1.09	Commercial item std. A-A-3097
498™ SUPER BONDER®	49850 49861	1 oz. bottle 1 lb. bottle	Thermal cycling	Clear	0.007	Ethyl	500	3,000	-65°F (-54°C) to 180°F (82°C)	Fixture – 50 sec. Full – 24 hrs.	1.10	N/A
499™ SUPER BONDER®	49904 21924 49945 49974	3 g tube 10 g syringe 20 g tube 200 g tube	Thermal cycling gel	Clear	0.010	Ethyl	Gel	3,200	-65°F (-54°C) to 200°F (93°C)	Fixture – 75 sec. Full – 24 hrs.	1.10	N/A
QUICKTITE®	39202	0.14 oz. bottle	General gel	Clear	0.010	Ethyl	Gel	2,800	-65°F (-54°C) to 180°F (82°C)	Fixture – 45 sec. Full – 24 hrs.	1.10	N/A
3092™	1321706	10 g syringe with 3 mix nozzles	High gap filling plastic bonder	Clear	0.080	Ethyl	Gel	3,200	-4°F (-20°C) to 176°F (80°C)	Fixture 0.002" gap – 15 sec. 0.008" gap – 3.5 min. Full – 24 hrs.	1.05	N/A

GENERAL-PURPOSE

BONDING

Cyanocrlates

ITEMS IN RED = Source's PICK or NEW

 = Indicates Worldwide Availability

- * Grit-blasted steel.
- ** Varies with substrates.
- ‡ Data generated using polycarbonate.
- † Full Cure = 24 hours without UV exposure. (With UV exposure, see Technical Data Sheets.)
- ‡ Contains Loctite® 382™ Tak Pak® Instant Adhesive (20 g bottle), Loctite® 7452™ Tak Pak® Accelerator (0.7 oz. net wt. aerosol can).
- †† Contains Loctite® 444™ Tak Pak® Instant Adhesive (20 g bottle), Loctite® 7452™ Tak Pak® Accelerator (1.75 fl. oz. liquid brush-top bottle).

PLEASE NOTE: A complete line of surface primers, accelerators and cleaners is available to further enhance the performance of Loctite® Instant Adhesives. Refer to the Surface Preparation section on page 135.

NEW 10 ML GEL CA SYRINGE DISPENSER

The 10 ml Gel CA Syringe Dispenser is a handheld, manually operated dispenser for any product packaged in 10 ml syringes. This dispenser provides a convenient, cost-effective method to apply product.

FEATURES:

- Pistol configuration for ease of application
- Full-hand trigger minimizes operator fatigue
- Easy syringe loading and smooth dispensing
- Lightweight – only 120 grams

Item # 1233800 10 ml Gel CA Syringe Dispenser
1233798 Replacement Plunger (For standard 0.5 in. diameter syringes)

ADDITIONAL RESOURCES

Your Source for **BONDING** **CYANOACRYLATE** **EQUIPMENT**

YOUR EQUIPMENT *Source*

For more details, see the **Loctite® Equipment Sourcebook, LT-3669**, or visit us on the web for additional information, diagrams, products and our full line of equipment at www.equipment.loctite.com.









LOCTITE® PRODUCT		ITEM NUMBER	USED TO DISPENSE	PACKAGE TYPES & SIZES	VISCOSITY RANGE	
HANDHELD APPLICATORS	BOTTLE DISPENSING					
		SOFT SQUEEZE BOTTLES	98345	All Fluids	2 fl. oz. packages	Low to Medium
			98346	All Fluids	4 fl. oz. packages	
			98347	All Fluids	8 fl. oz. packages	

LOCTITE® PRODUCT		ITEM NUMBER	TYPE	VISCOSITY RANGE	DISPENSE PATTERNS	USED TO DISPENSE	STROKE ADJUSTMENT	ACTUATION	CONSUMABLES – DISPENSE ACCESSORIES	
HANDHELD VALVES	LOW VISCOSITY CYANOACRYLATE APPLICATOR									
		LV HAND-HELD APPLICATOR	97130	Pneumatic	Low	Drop, Dot, Bead	Instant Adhesives, Retaining Compounds, Threadlockers	Yes	Foot	Dispense Tips and Accessories – Pages 182-186
		PINCH TUBE APPLICATORS								
		VARI-DROP™ APPLICATORS	97131	Pinch Tube	Low to Medium	Drop, Dot, Bead	Instant Adhesives, Retaining Compounds, Threadlockers	Yes	Finger	Dispense Tips and Accessories – Pages 182-186
			97132							



LOCTITE® PRODUCT		ITEM NUMBER	TYPE	VISCOSITY RANGE	DISPENSE PATTERNS	USED TO DISPENSE	STROKE ADJUSTMENT	SUCK-BACK	CONSUMABLES – DISPENSE ACCESSORIES	
VALVES & PUMPS	HIGH PRECISION VALVES									
		STATIONARY APPLICATOR VALVE	97113	High Precision	Low to Medium	Drop, Dot, Bead	Gel Instant Adhesives, Instant Adhesives, Retaining Compounds, Threadlockers	Yes	Yes	Dispense Tips and Accessories – Pages 182-186
			97114							
	HIGH PERFORMANCE DIAPHRAGM VALVES									
		CYANOACRYLATE DISPENSE VALVE	98013	High Performance Diaphragm	Low to Medium	Drop, Dot, Bead, Microdot	Instant Adhesives, Retaining Compounds, Threadlockers	Yes	No	Dispense Tips and Accessories – Pages 182-186
PINCH TUBE VALVE										
	SHOT MISER™ DISPENSE VALVE	98085	Pinch Tube Valve	Low to Medium	Drop, Dot, Bead	Instant Adhesives, Retaining Compounds, Threadlockers	No	No	Dispense Tips and Accessories – Pages 182-186	



LOCTITE® PRODUCT		ITEM NUMBER	CONTROLLED OUTPUTS	NUMBER OF DISPENSE VALVES	ADVANCING SLIDE	ROTOSPRAY	ACCESSORIES
MULTIFUNCTION CONTROLLERS		DUAL CHANNEL AUTOMATIC CONTROLLER	97152	6	2 (Independent)	97118 – 50 mm 97119 – 100 mm	97115
		SPRAY VALVE DIGITAL CONTROLLER	1406023	1	1	N/A	N/A
		DIGITAL MULTIFUNCTIONAL CONTROLLER	1022006	3	3 (Independent)	984691 – 50 mm	In conjunction with Positive Displacement Pump – 983330
SINGLE FUNCTION CONTROLLERS		DIGITAL DISPENSE CONTROLLER	97101	1	1	N/A	N/A
		SHOT MISER™ VALVE CONTROLLER	98079	1	1	N/A	N/A

Visit www.equipment.loctite.com for more information on additional accessories.

LOCTITE® PRODUCT		ITEM NUMBER	DISPENSE PATTERNS	USED TO DISPENSE	PACKAGE TYPES & SIZES	VISCOSITY RANGE	VACUUM SUCK-BACK	CONSUMABLES – DISPENSE ACCESSORIES	
VOLUMETRIC BOTTLE DISPENSING									
	BENCHTOP PERISTALTIC DISPENSER	98548	Dot, Drop, Bead	Instant Adhesives, Light Cure/Acrylics, Retaining Compounds, Threadlockers	Any	0 to 5,000 cP	N/A	Dispense Tips and Accessories – Pages 182-186	
COMPLETE PRESSURE-TIME BOTTLE DISPENSE SYSTEM									
	BOND-A-MATIC® 3000 DISPENSER 0-15 psi	982719	Dot, Drop, Bead	Gel Adhesives, Instant Adhesives, Light Cure/Acrylics, Retaining Compounds, Threadlockers	200 ml bottle 1 lb. bottle 1 liter bottle 2 kg bottle 200 g squeeze tube	Low Medium to High	N/A	Dispense Tips and Accessories – Pages 182-186	
	BOND-A-MATIC® 3000 DISPENSER 0-100 psi	982722							
	SHOT MISER™ VALVE CONTROLLER	98079	Dot, Drop, Bead	Instant Adhesives, Light Cure/Acrylics, Retaining Compounds, Threadlockers	250 ml bottle 1 lb. bottle	Low to Medium	N/A		
	SHOT MISER™ DISPENSE VALVE	98085							
	SHOT MISER™ RESERVOIR	98090							
SYRINGE DISPENSING SYSTEMS									
	POSI-LINK™ DISPENSING SYSTEM	See Pg 181	Dot, Drop, Bead	Gel Adhesives, Instant Adhesives, Light Cure/Acrylics, Epoxies	Prepackaged 5 ml syringe 10 ml syringe 25 ml syringe	Low to Paste	Yes	Dispense Tips and Accessories – Pages 182-186	
	PRECISION SYRINGE DISPENSING SYSTEM	97006*	Dot, Drop, Bead	Gel Adhesives, Instant Adhesives, Light Cure/Acrylics	3 ml syringe 5 ml syringe 10 ml syringe 30 ml syringe 55 ml syringe	Low to Paste	Yes	Syringes – Page 184	
	DIGITAL SYRINGE DISPENSING SYSTEM	883976							Yes
	FOOT PEDAL DISPENSER	98050*							Yes

* Syringe Airline Adapter sold separately. Visit www.equipment.loctite.com for all available accessories.

LOCTITE® PRODUCT		ITEM NUMBER	PRESSURE REGULATION	USED TO DISPENSE	PACKAGE TYPES & SIZES	VISCOSITY RANGE	LOW LEVEL SENSING	CONSUMABLES – DISPENSE ACCESSORIES
PNEUMATIC CARTRIDGE DISPENSING								
	300 ML PNEUMATIC CARTRIDGE DISPENSING RETAINER	98319A	0 to 60 psi	Gel Cyanoacrylates, Anaerobic Gasketing, Light Cure/Acrylics, Silicones	300 ml cartridges	Low to Medium	Pneumatic	Cartridge Accessories – Page 183
	PNEUMATIC HANDHELD 300 ML DISPENSER	1294304	0 to 100 psi	Gel Cyanoacrylates, Anaerobic Gasketing, Light Cure/Acrylics, Silicones	300 ml cartridges 250 ml tubes	Medium to High	No	
	300 ML CARTRIDGE PUSHER	98022	0 to 50 psi	Gel Cyanoacrylates, Anaerobic Gasketing, Light Cure/Acrylics, Low Viscosity Silicones	300 ml cartridges 250 ml tubes	Medium	Yes	

LOCTITE® PRODUCT		ITEM NUMBER	PRESSURE REGULATION	USED TO DISPENSE	PACKAGE TYPES & SIZES	VISCOSITY RANGE	LOW LEVEL SENSING	CONSUMABLES – DISPENSE ACCESSORIES
INTEGRATED RESERVOIR CONTROLLERS								
	INTEGRATED SEMI-AUTOMATIC DISPENSER	1390322	0 to 15 psi	Gel Adhesives, Instant Adhesives, Light Cure/Acrylics, Retaining Compounds, Threadlockers	250 ml bottle 1 lb. bottle 1 liter bottle 2 kg bottle 200 g squeeze tube	Low to Medium Medium to High	Yes	Dispense Tips and Accessories – Page 182-186
		1390321	0 to 100 psi				Yes	
RESERVOIRS								
	BOND-A-MATIC® 3000 RESERVOIR	982720	0 to 15 psi	Gel Adhesives, Instant Adhesives, Light Cure/Acrylics, Retaining Compounds, Threadlockers	250 ml bottle 1 lb. bottle 1 liter bottle 2 kg bottle 200 g squeeze tube	Low to Medium Medium to High	Yes	Dispense Tips and Accessories – Page 182-186
		982726					No	
		982723	0 to 100 psi				Yes	
		982727					No	
	SHOT MISER™ RESERVOIR	98090	0 to 100 psi	Instant Adhesives, Light Cure/Acrylics, Retaining Compounds, Threadlockers	250 ml bottle 1 lb. bottle 200 g squeeze tube	Low to High	No	

Your Source for **BONDING**
HOT MELTS

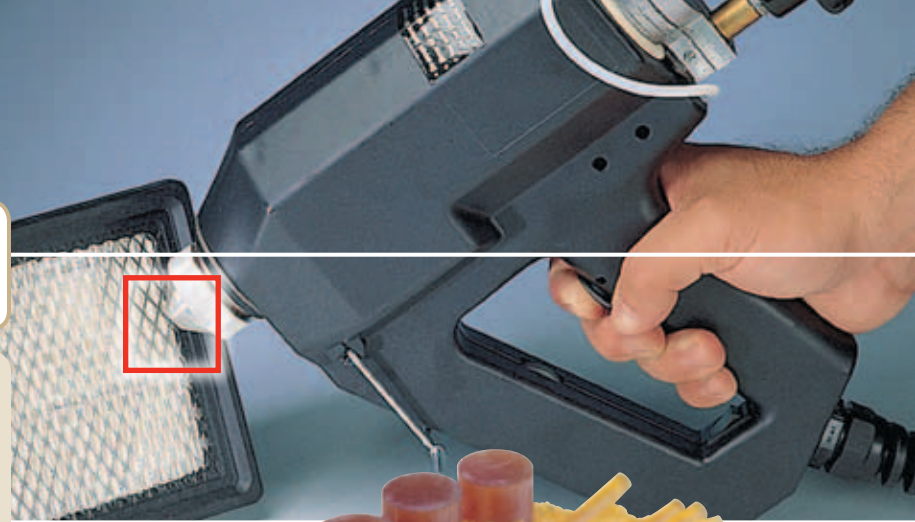

- Bond a variety of substrates, including difficult-to-bond plastics
- Can handle today's toughest applications in a broad range of industries
- Ideal for applications that require high speed manufacturing, bonding versatility, very large gap filling, fast green strength and minimal shrinkage
- Solvent-free and contain environmentally responsible materials with no harmful VOCs

[Polyolefin-Based]

Loctite® 0430™ Hysol® SprayPac™ Polyshot Hot Melt Adhesive

MEDIUM OPEN TIME

Suitable for bonding expanded polystyrene, polyethylene and urethane foams. Can be used in applications where solvent-based aerosols are used.

Item # 83349 Polyshot 35 lb. carton

[Urethane-Based]

Loctite® 3631™ Hysol® Hot Melt Adhesive

HIGH STRENGTH

A toughened, high strength adhesive for use on plastics. Flexible bond with an open time of 60 seconds.

Item # 31291 300 ml cartridge
31279 40 lb. pail

Loctite® 7809FR™ Hysol® Hot Melt Adhesive

FIRE RETARDANT

Modified with fire retardant materials. It has a UL 94V-0 flammability rating.

Item # 83390 Superstick 13 oz. bag
83675 Superstick 32 lb. carton
83676 Polyshot 25 lb. pail

Loctite® 7811™ Hysol® Hot Melt Adhesive

HIGH TEMPERATURE

A high performance polyamide with exceptional high temperature- and impact-resistance at low temperatures.

Item # 83337 5 lb. sample bag pellets
83339 Polyshot 10 in. 13 oz. sample bag
83340 Polyshot 25 lb. pail
83338 40 lb. carton pellets

Loctite® 7901™ Hysol® Hot Melt Adhesive

POTTING

Low viscosity polyamide used extensively for potting and encapsulating.

Item # 83342 40 lb. carton pellets
83344 Polyshot 25 lb. pail

Loctite® 0450™ Hysol® SprayPac™ Polyshot Hot Melt Adhesive

EXTENDED OPEN TIME

Formulated for spray applications, this adhesive is well-suited for use on expanded polystyrene or urethane foams.

Item # 83354 Polyshot 35 lb. carton
83356 Polyshot 35 lb. carton (RED)

[Polyamide-Based]

Loctite® 7460™ Hysol® SprayPac™ Polyshot Hot Melt Adhesive

SPRAYABLE

Formulated for spray applications. High heat resistance and fast set time. Suitable for bonding foams, fabric and wood.

Item # 83308 Polyshot 25 lb. pail

Loctite® 0452™ Hysol® SprayPac™ Hot Melt Adhesive

EXTENDED OPEN TIME

Formulated to be spray-applied to a wide variety of substrates. Excellent for bonding expanded polystyrene or urethane foams.

Item # 83257 SprayPac™ 21 lb. pucks
83677 36 lb. carton bricks

Loctite® 7500™ Hysol® SprayPac™ Polyshot Hot Melt Adhesive

LONG OPEN TIME

Formulated for long open time and high output for bonding surfaces up to 15 square feet.

Item # 83312 Polyshot 13 oz. sample bag
83313 Polyshot 25 lb. pail

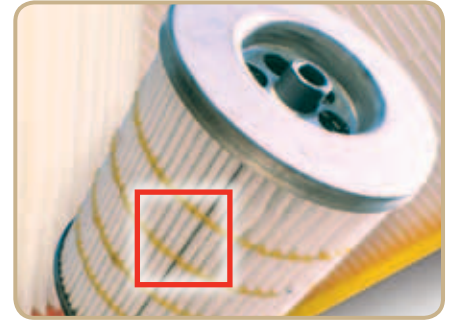
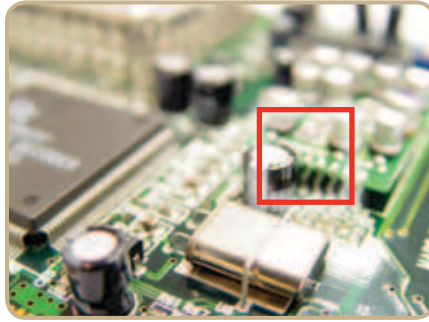

[Applications]

- Paper-to-paper adhesives
- Corrugated paper bonding
- Packaging components
- Foam bonding for inserts
- Foam bolster assembly
- Foam gasket placement
- EPS sheet lamination
- Insulation to metal or wood
- Wood assembly
- Nonwoven bonding

[Industries]

- Automotive
- Filters
- Packaging
- General Industries
- Electronics
- Marine
- Specialty Vehicles
- Arts and Crafts
- Panel Lamination
- Insulation and HVAC
- Furniture and Woodworking
- Textile and Nonwoven

APPLICATIONS
& INDUSTRIES

[EVA-Based]

Loctite® 1X™ Hysol® Hot Melt Adhesive

FAST SETTING

Medium to fast setting; recommended for bonding paper, wood, fabric and foam.

Item #	83357	5 lb. sample bag pellets
	83358	40 lb. carton pellets
	83360	Maxistick 35 lb. carton
	83365	Superstick 10 in. 25 lb. carton
	83368	Polyshot 35 lb. carton

Loctite® 3X™ Hysol® Polyshot Hot Melt Adhesive

POROUS SUBSTRATES

Used extensively for bonding sand molds and other porous substrates.

Item #	83369	Polyshot 12 oz. sample bag
	83370	Polyshot 35 lb. carton

Loctite® 232™ Hysol® Hot Melt Adhesive

MEDIUM OPEN TIME

A medium setting adhesive with an open time of 15 seconds.

Item #	83239	40 lb. carton pellets
	83241	Maxistick 35 lb. carton
	83245	Superstick 10 in. 25 lb. carton
	83247	Polyshot 35 lb. carton

Source's PICK

Loctite® 1942™ Hysol® Hot Melt Adhesive

GENERAL-PURPOSE

Medium setting, general-purpose hot melt adhesive. Excellent adhesion to wood and many plastics.

Item #	83266	5 lb. sample bag pellets
	83267	40 lb. carton pellets
	83269	Maxistick 35 lb. carton
	83271	PT™ stick 35 lb. carton
	83272	Ministick 35 lb. carton
	83273	5 oz. sample bag
	83274	Superstick 10 in. 25 lb. carton
	83275	Superstick 4 in. 25 lb. carton
	83276	12 oz. sample bag
	83277	Polyshot 35 lb. carton

Loctite® 4046™ Hysol® Hot Melt Adhesive

EXTENDED OPEN TIME

Highly flexible, with a 60-second open time for demanding substrates such as rubber and polyethylene.

Item #	83278	Polyshot 12 oz. sample bag
	83279	Polyshot 35 lb. carton

Loctite® CoolMelt™ Hysol® Hot Melt Adhesive

LOW TEMPERATURE

Flexible material designed to be applied at low temperatures. Ideal for bonding heat-sensitive parts.

Item #	83393	CoolMelt™ Maxistick 7 oz. sample bag
	83394	CoolMelt™ Maxistick 35 lb. carton

Loctite® SuperPac™ Hysol® Hot Melt Adhesive

CARDBOARD BONDER

A medium setting material with a 30-second open time. It is formulated to bond cardboard and foams.

Item #	83404	Polyshot 12 oz. sample bag
	83405	Polyshot 35 lb. carton

Loctite® QuickPac™ Hysol® Hot Melt Adhesive

FAST SETTING

A low cost carton sealing adhesive with a 15-second open time.

Item #	83399	Polyshot 12 oz. sample bag
	83398	Maxistick 35 lb. carton
	83400	Polyshot 35 lb. carton
	83396	40 lb. carton pellets

Your Source for **BONDING**
HOT MELTS

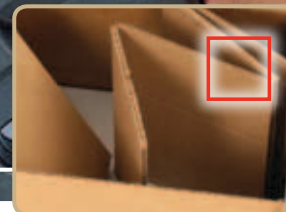

[Loctite® Hysol® Hot Melt Adhesives Properties Chart]

	LOCTITE® PRODUCT	ITEM NUMBER	PACKAGE TYPE/SIZE	COLOR	ATTRIBUTES	VISCOSITY (cP) AT DISPENSE TEMPERATURE	TENSILE STRENGTH (psi)	OPEN TIME	TEMPERATURE RESISTANCE	% ELONGATION	HARDNESS (SHORE A)	AGENCY APPROVALS
GENERAL-PURPOSE	0430™ HYSOL® SPRAYPAC™	83349	Polyshot 35 lb. carton	Cream	Medium open time	5,000	280	3.5 minutes sprayed	170°F (77°C)	N/A	75	N/A
	0450™ HYSOL® SPRAYPAC™	83354	Polyshot 35 lb. carton	Natural	Extended open time	4,500	N/A	5 to 8 minutes	156°F (69°C)	N/A	N/A	N/A
	0450™ RED HYSOL® SPRAYPAC™	83356	Polyshot 35 lb. carton	Pink	Extended open time	4,500	N/A	5 to 8 minutes	156°F (69°C)	N/A	N/A	N/A
	0452™ HYSOL® SPRAYPAC™	83257 83677	SprayPac™ 21 lb. pucks 36 lb. carton bricks	Natural	Extended open time	4,300	N/A	5 to 8 minutes	156°F (69°C)	N/A	N/A	N/A
URETHANE- BASED	3631™ HYSOL®	31291 31279	300 ml cartridge 40 lb. pail	Off- White	High strength	12,000	1,800	60 seconds	250°F (121°C)	940	91	N/A
POLYAMIDE-BASED	7460™ HYSOL® SPRAYPAC™	83308	Polyshot 25 lb. pail	Pale Amber	Sprayable	6,700	N/A	30 seconds	210°F (99°C)	N/A	N/A	N/A
	7500™ HYSOL® SPRAYPAC™	83312 83313	Polyshot 13 oz. sample bag Polyshot 25 lb. pail	Pale Amber	Long open time	1,900	N/A	2 minutes	200°F (93°C)	N/A	N/A	N/A
	7804™ HYSOL®	83325 83326 83327 83328 83330	5 lb. sample bag pellets 40 lb. carton pellets Superstick (10 in.) 5 oz. sample bag Superstick (10 in.) 32 lb. carton Polyshot 25 lb. pail	Amber	High viscosity	7,500	340	35 seconds	220°F (104°C)	900	74	N/A
	7809FR™ HYSOL®	83390 83675 83676	Superstick 10 in. 13 oz. bag Superstick 10 in. 32 lb. carton Polyshot 25 lb. pail	Amber	Fire retardant	7,000	363	35 seconds	240°F (115°C)	373	85	UL 94V-0
	7811™ HYSOL®	83337 83339 83340 83338	5 lb. sample bag pellets Polyshot 13 oz. sample bag Polyshot 25 lb. pail 40 lb. carton pellets	Amber	High temperature	6,400 4,250 4,250 6,400	400	35 seconds	266°F (130°C)	1,200	N/A	N/A
	7901™ HYSOL®	83342 83344	40 lb. carton pellets Polyshot 25 lb. pail	Amber	Potting	750	260	35 seconds	300°F (149°C)	80	84	N/A

ITEMS IN RED = Source's PICK or NEW

[Loctite® Hysol® Hot Melt Adhesives Properties Chart]

LOCTITE® PRODUCT	ITEM NUMBER	PACKAGE TYPE/SIZE	COLOR	ATTRIBUTES	VISCOSITY (cP) AT DISPENSE TEMPERATURE	TENSILE STRENGTH (psi)	OPEN TIME (SECONDS)	TEMPERATURE RESISTANCE	% ELONGATION	HARDNESS (SHORE A)	AGENCY APPROVALS	
EVA-BASED	1X™ HYSOL®	83357 83358 83360 83365 83368	5 lb. sample bag pellets 40 lb. carton pellets Maxistick 35 lb. carton Superstick 10 in. 25 lb. carton Polyslot 35 lb. carton	Light Yellow	Fast setting	2,000	370	15	150°F (65°C)	90	N/A	N/A
	3X™ HYSOL®	83369 83370	Polyslot 12 oz. sample bag Polyslot 35 lb. carton	Tan	Porous substrates	4,000	580	60	135°F (57°C)	300	N/A	N/A
	232™ HYSOL®	83239 83241 83245 83247	40 lb. carton pellets Maxistick 35 lb. carton Superstick 10 in. 25 lb. carton Polyslot 35 lb. carton	Clear	Medium open time	11,000	N/A	15	153°F (67°C)	N/A	N/A	N/A
	236™ HYSOL®	83252	Superstick 10 in. 25 lb. carton	Clear	Medium viscosity	8,500	213	25	140°F (60°C)	450	N/A	N/A
	740™ HYSOL®	83260 83261 83264	Superstick 10 in. 5 oz. sample bag Superstick 10 in. 25 lb. carton Polyslot 35 lb. carton	Light Yellow	High strength	9,000	750	10	168°F (75°C)	75	N/A	N/A
	740LV™ HYSOL®	83373	40 lb. carton pellets	Light Yellow	High temperature	3,500	700	10	155°F (68°C)	80	N/A	N/A
	1942™ HYSOL®	83266 83267 83269 83271 83272 83273 83274 83275 83276 83277	5 lb. sample bag pellets 40 lb. carton pellets Maxistick 35 lb. carton PT™ stick 35 lb. carton Ministick 35 lb. carton 5 oz. sample bag Superstick 10 in. 25 lb. carton Superstick 4 in. 25 lb. carton 12 oz. sample bag Polyslot 35 lb. carton	Tan	General-purpose	5,000	250	30	142°F (61°C)	500	N/A	N/A
	4046™ HYSOL®	83278 83279	Polyslot 12 oz. sample bag Polyslot 35 lb. carton	Tan	Extended open time	19,000	120	60	120°F (48°C)	1,400	22	N/A
	COOLMELT™ HYSOL®	83393 83394	CoolMelt™ Maxistick 7 oz. sample bag CoolMelt™ Maxistick 35 lb. carton	Off-White	Low temperature application	7,200	195	15	140°F (60°C)	800	N/A	N/A
	SUPERPAC™ HYSOL®	83404 83405	Polyslot 12 oz. sample bag Polyslot 35 lb. carton	Light Yellow	Cardboard bonder	5,750	280	30	144°F (62°C)	200	N/A	N/A
	QUIKPAC™ HYSOL®	83399 83398 83400 83396	Polyslot 12 oz. sample bag Maxistick 35 lb. carton Polyslot 35 lb. carton 40 lb. carton pellets	Light Yellow	Low viscosity	4,645	N/A	15	174°F (79°C)	N/A	N/A	N/A

ITEMS IN RED = Source's PICK or NEW

[Loctite® Hysol® Hot Melt Stick Chart]







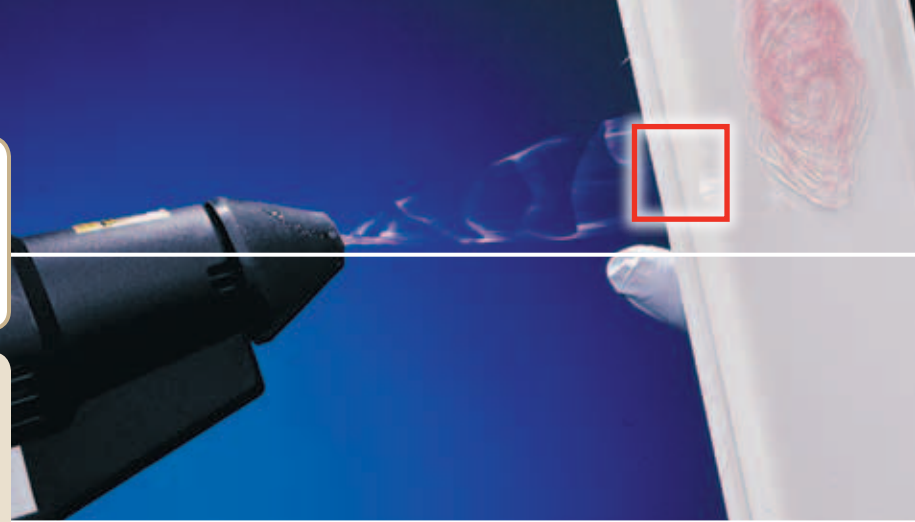

DESCRIPTION	DIAMETER	LENGTH	LOCTITE® APPLICATORS BY ITEM NUMBER
SUPERSTICK	0.50 in.	4 in./10 in.	98544, 98545
MAXISTICK	0.75 in.	2.4 in.	98033, 98034
POLYSHOT	1.75 in.	1.5 in.	98035, 98036, 98040, 98037, 98041

Your Source for **BONDING**
HOT MELTS
EQUIPMENT













YOUR EQUIPMENT Source



















For more details, see the **Loctite® Equipment Sourcebook, LT-3669**, or visit us on the web for additional information, diagrams, products and our full line of equipment at www.equipment.loctite.com.



LOCTITE® PRODUCT		ITEM NUMBER	STICK DIAMETER	DISPENSE MELT RATE	DISPENSE POWER	DISPENSE TEMPERATURE	HOT MELT CHEMISTRY	HOT MELT NOZZLES & ACCESSORIES
1/2 INCH SUPERSTICK DISPENSERS								
	HYSOL™ 050A	916282	1/2 in. Superstick Sticks	4 lbs./hr.	Manual	383°F (195°C)	EVA/Polyolefin	Hot Melt Nozzles and Accessories – Page 18
	HYSOL™ 050-HT	98545	1/2 in. Superstick Sticks	4 lbs./hr.	Manual	419°F (215°C)	Polyamide	
3/4 INCH MAXISTICK DISPENSERS								
	HYSOL™ 075	98033	3/4 in. Maxistick Sticks	9 lbs./hr.	Manual	360°F (182°C)	EVA	Hot Melt Nozzles and Accessories – Page 18
	HYSOL™ 075-LT	98034	3/4 in. Maxistick Sticks	5 lbs./hr.	Manual	249°F (121°C)	CoolMelt™	
1 3/4 INCH SPRAYPAC® & POLYSHOT DISPENSERS								
	HYSOL™ 175-AIR	98036	1 3/4 in. Polyshot Sticks	8 lbs./hr.	Electric	383°F (195°C)	EVA/Polyolefin	Hot Melt Nozzles and Accessories – Page 18
	HYSOL™ 175-AIR-HT	98040	1 3/4 in. Polyshot Sticks	8 lbs./hr.	Electric	419°F (215°C)	EVA/Polyolefin	
	HYSOL™ 175-SPRAY	98037	1 3/4 in. Polyshot Sticks	8 lbs./hr.	Electric	383°F (195°C)	EVA/Polyolefin	
	HYSOL™ 175-SPRAY-HT	98041	1 3/4 in. Polyshot Sticks	8 lbs./hr.	Electric	419°F (215°C)	Polyamide	
	HYSOL™ 175	98035	1 3/4 in. Polyshot Sticks	6.6 lbs./hr.	Manual	383°F (195°C) and 419°F (215°C)*	EVA/Polyolefin and Polyamide	
URETHANE DISPENSER								
	HYSOL™ REACTIVE URETHANE CARTRIDGE DISPENSER	98011	N/A	3 lbs./hr.	Air	249°F (121°C)	Reactive Urethane	Hot Melt Nozzles and Accessories – Page 18
HOT MELT BENCH MOUNT & CONTROLLER OPTIONS								
	HOT MELT BENCH MOUNT KIT	98042	N/A	N/A	N/A	N/A	EVA/Polyamide	Hot Melt Nozzles and Accessories – Page 18
	HOT MELT PNEUMATIC TIMER	98043						

* The Loctite® Hysol™ 175 Dispenser (manual electric) is supplied with both temperature modules.

LOCTITE® PRODUCT	ITEM NUMBER	DESCRIPTION	USED WITH
	988107 (SINGLE PACK)	Adapter/Check Valves for Nozzles	98544, 98545
	419115 (SINGLE PACK)		98030, 98031, 98032, 98035, 98036, 98040
	98687 (5 PACK)		916282
	ANZ023N01	Standard Nozzle Adapter with Check Valve and Jam Nut	98033, 98034
	988108 (5 PACK)	1-Hole Nozzle 0.08" diameter cone tip (5 pack)	98544, 98545
	985225 (5 PACK)		98030, 98031, 98032, 98033, 98034, 98035, 98036, 98040
	916050 (5 PACK)	1-Hole Nozzle 0.09" diameter cone tip	916282
	985110	2-Hole Nozzle 0.06" diameter x 0.39" spacing	98030, 98031, 98032, 98033, 98034, 98035, 98036, 98040, 98544, 98545
	985111	3-Hole Nozzle 0.06" diameter x 0.20" spacing	98030, 98031, 98032, 98033, 98034, 98035, 98036, 98040, 98544, 98545
	985112	Diagonal Extension Nozzle Tip = 0.14" diameter x 1.23" long	98030, 98031, 98032, 98033, 98034, 98035, 98036, 98040, 98544, 98545
	985113	Needle Extension Nozzle Tip = 0.05" diameter x 1.32" long	98030, 98031, 98032, 98033, 98034, 98035, 98036, 98040, 98544, 98545
	985114	Spreader Extension Nozzle Tip = (0.09" x 0.25") x 1.32" long	98030, 98031, 98032, 98033, 98034, 98035, 98036, 98040, 98544, 98545
	985115	L-Nozzle 0.06" diameter x 0.85" offset	98033, 98034, 98035, 98036, 98040, 98544, 98545
	985116	T-Nozzle 0.06" diameter x 1.5" spacing	98033, 98034, 98035, 98036, 98040, 98544, 98545
	985122	Standard Medium Spray Nozzle 1.25" to 5" diameter pattern	98037, 98041
	985211	Narrow Spray Nozzle 0.05" to 1.25" diameter pattern	98037, 98041
	985216	Ultra-Wide Spray Nozzle 1.5" to 6.0" diameter pattern	98037, 98041

LOCTITE® PRODUCT	ITEM NUMBER	DESCRIPTION	USED WITH
	984999	Standard 1-Hole Nozzle with Integral Check Valve – Tip = 0.10" diameter x 0.16" long	98029
	985001	Spreader Nozzle with Integral Check Valve – Tip = (0.08" x 0.25") x 0.47" long	98029
	985002	Pencil Point Nozzle with Integral Check Valve – Tip = 0.08" diameter x 0.24" long	98029
	985003	Precision Nozzle with Integral Check Valve – Tip = 0.05" diameter x 0.20" long	98029
	985004	Extension Nozzle with Integral Check Valve – Tip = 0.10" diameter x 0.50" long	98029
	985005	Silicone Rubber Safety Cap (2 pack) (for use with 984999, 985002, 985004)	98029
	98012	Cartridge Pre-Heater Holds (2) 300 ml cartridges	98011
	984261	Standard Adapter for 300 ml Cartridges	98011
	984262	Standard 1-Hole Nozzle 0.098" diameter cone tip, with integral check valve (includes protective cap)	98011
	984263	Adapter/Check Valve for Specialty Nozzles	98011
	984264	Needle Jet Nozzle Tip = 0.051" diameter x 1.26" long (requires 984263 adapter)	98011
	984265	Diagonal Extension Nozzle Tip = 0.123" diameter x 1.276" long (requires 984263 adapter)	98011
	984266	Flat Spreader Nozzle Tip = (0.084" x 0.177") sq. x 1.237" long (requires 984263 adapter)	98011
	984267	2-Hole Nozzle 0.06" diameter x 0.39" spacing (requires 984263 adapter)	98011
	984268	3-Hole Nozzle 0.06" diameter x 0.20" spacing (requires 984263 adapter)	98011
	984272	Injection Needle Nozzle with Integral Check Valve Tip = 0.059" diameter x 0.197" long	98011
	985087	Heavy Duty Metal Stand for Benchtop or Wall Mounting	98030, 98031, 98032, 98035, 98036, 98037, 98040, 98041
	985243	Tool Hanger/Balancer – 0 to 1.5 kg	All Hot Melt Applicators
	985397	Air Line Filter, Regulator, 5 Micron Filter Gauge 0 to 150 psi	All Pneumatic Applicators

For custom hot melt dispense nozzles, contact the Special Equipment Group of Henkel at 1-800-LOCTITE (562-8483).
STRAIGHT FROM *The Source*

BONDING LIGHT CURE ADHESIVES

- Used in bonding, encapsulating, coating, tacking and sealing applications
- Single component, solvent-free
- Cure in seconds when exposed to UV/visible light sources
- Some light cure adhesives can be combined with activator-curing methods to meet specific application requirements

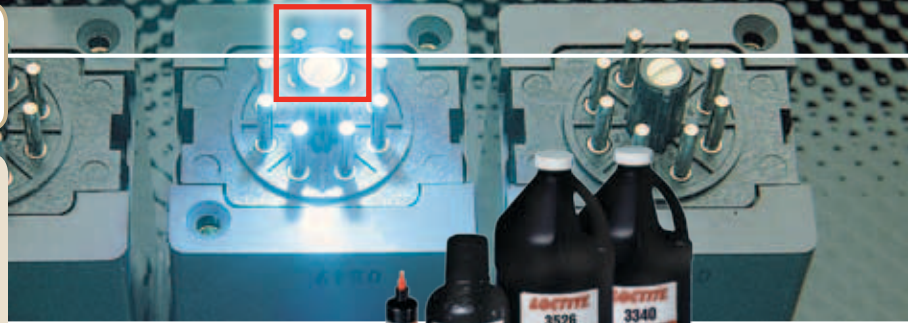

[Epoxy Adhesives]

Loctite® 3336™ Light Cure Adhesive

A UV cure, medium viscosity, two-part epoxy. UV cure effects fast gelation. Complete cure at room temperature or heat cure. Tough and durable. Designed for potting, bonding and sealing.

Item #	31064	42 ml dual syringe
	31065	400 ml dual syringe

Loctite® 3355™ Light Cure Adhesive

PRE-ACTIVATED EPOXY

A UV cure, medium viscosity, one-part epoxy. Unique delay feature allows UV cure of non-light-transmitting substrates. Extremely low shrinkage is ideal when alignment of small parts is critical. Low outgassing and acid-free.

Item #	40792	25 ml syringe
	40793	1 liter bottle

[Cyanoacrylates Adhesives]

Loctite® 4306™ Flashcure® Light Cure Adhesives

DUAL CURE INSTANT ADHESIVE

New, patented technology. One-component, low viscosity fluorescent adhesives. Specifically formulated for extremely rapid UV or visible light cure and secondary cyanoacrylates cure mechanism. Eliminates the need for solvent-based accelerators.

Item #	4306™	37439	1 oz. bottle
	4306™	37442*	1 lb. bottle

Source's PICK

Loctite® 4310™ / 4311™ Flashcure® Light Cure Adhesives

DUAL CURE INSTANT ADHESIVE

Toughened fluorescent adhesives that tack-free cure extremely fast (2-5 seconds). Specifically formulated for extremely rapid UV or visible light cure and secondary cyanoacrylates cure mechanism.

Item #	4310™	1401792	1 oz. bottle
	4310™	1401790	1 lb. bottle
	4311™	1401791	1 oz. bottle
	4311™	1401789	1 lb. bottle

[Silicone Adhesives]

Loctite® 5031™ Nuva-Sil® Silicone Potting Compound

HIGH ADHESION/VISIBLE LIGHT

A UV or visible light curing silicone for high speed potting, coating and sealing applications. High adhesion for difficult-to-bond substrates.

Item #	40086	300 ml cartridge
	40087	40 lb. pail

Loctite® 5033™ Nuva-Sil® Silicone Adhesive Sealant

PASTE/HIGH ADHESION/VISIBLE LIGHT

A UV or visible light and moisture curing silicone for high speed adhesion and sealing applications. High adhesion for difficult-to-bond substrates.

Item #	40088	300 ml cartridge
	40089	40 lb. pail

Loctite® 5039™ Nuva-Sil® Silicone Adhesive Sealant

CURE-IN-PLACE GASKETING COMPOUND

A UV or visible light and moisture curing silicone for high speed adhesion, gasketing and sealing applications. High adhesion for difficult-to-bond substrates.

Item #	40438	300 ml cartridge
	40439	40 lb. pail

The Electromagnetic Spectrum

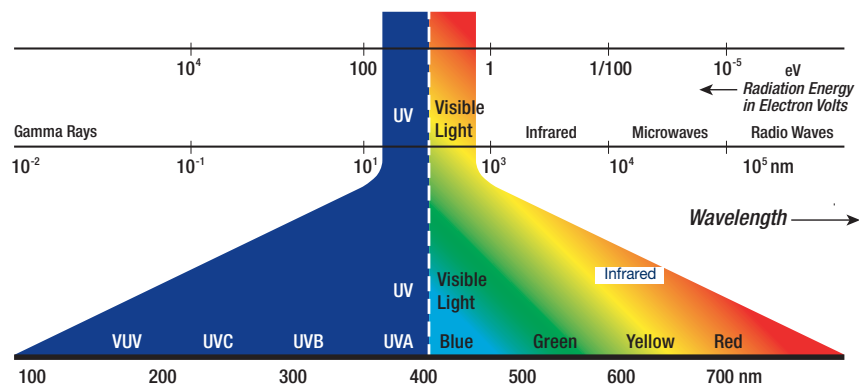

* Made-to-order item

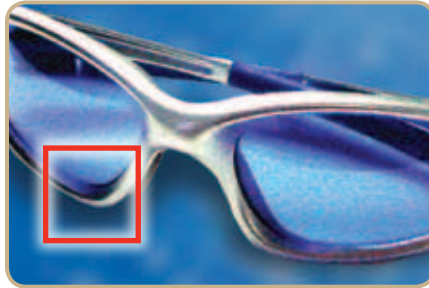

[Applications]

- PVC tube to ABS connector
- PC windows to ABS housing
- Logos and plastic parts in the cosmetic industry
- Polyurethane foam to PVC plastics

- Wide variety of medical devices
- Deep cure and high adhesion areas to blue tinted thermoplastic, e.g., irons
- Purple-tinted medical components where biocompatibility is an absolute requirement
- Pre-filled drug syringes

- Items where speed of cure and cure through blue and grey components are required, e.g., high-end sunglasses
- Dust cap to cone for speaker assembly

Loctite® 5050™ Fastgasket® Silicone Adhesive Sealant

CURE-IN-PLACE GASKETING COMPOUND

A UV light curing, noncorrosive silicone for high speed adhesion, gasketing and sealing applications. High adhesion for difficult-to-bond substrates.

Item #	1212166	300 ml cartridge
	1212165	40 lb. pail

Loctite® 5055™ Silicone Adhesive Sealant

SELF-LEVELING/FLOWABLE

A UV or visible light curing, noncorrosive silicone for high speed coating, potting adhesion or sealing applications. High adhesion for difficult-to-bond substrates.

Item #	1212167	25 ml syringe
	1214246	1 liter bottle
	1214247	15 liter pail*

Loctite® 5056™ Silicone Adhesive Sealant

SELF-LEVELING/HIGH ADHESION

A UV or visible light curing, noncorrosive silicone with very high bond strength. Ideal for high speed adhesion and sealing applications. High adhesion for difficult-to-bond substrates.

Item #	1214249	25 ml syringe
	1214250	1 liter bottle
	1214248	15 liter pail*

Loctite® 5240™ Nuva-Sil® Medical Device Sealant

SELF-LEVELING/NONCORROSIVE

A UV or visible light and moisture curing, noncorrosive silicone ideal for high speed adhesion and sealing applications. High adhesion for difficult-to-bond substrates.

Item #	1010341	30 ml syringe
	1010320	300 ml cartridge
	1010343	40 lb. pail

[Acrylic Adhesives]

Loctite® 352™ Light Cure Adhesive

A high viscosity adhesive that creates a tough, flexible bond that is resistant to vibration and shock. Effective on a wide range of materials. Cures in minutes using an activator, UV light or both.

Item #	35241	50 ml bottle
	35286	1 liter bottle

Loctite® 3103™ Light Cure Adhesive

Thixotropic, flexible, low modulus, medium viscosity, UV/visible light cure adhesive for flexible bonds and reduced stress cracking on plastics. Cures through UV-blocked and tinted substrates. Also for potting, sealing and gap filling.

Item #	23691	25 ml syringe
	23692	1 liter bottle

Loctite® 3105™ Light Cure Adhesive

A high strength, low viscosity, UV/visible light cure adhesive. Primarily designed for bonding rigid and flexible PVC to polycarbonate. Enables easy assembly of components with close-fitting tolerances. Recommended for applications involving small gaps less than .98 in. (0.25 mm).

Item #	23695	25 ml syringe
	23696	1 liter bottle

Loctite® 3106™ Light Cure Adhesive

A high strength, medium viscosity, thixotropic, UV/visible light cure adhesive. Designed primarily for bonding rigid and flexible PVC to polycarbonate where large gap filling capabilities and a flexible joint are desired.

Item #	23697	25 ml syringe
	23698	1 liter bottle

Loctite® 3107™ Light Cure Adhesive

A low viscosity, UV/visible light cure adhesive for difficult-to-bond plastics including plasticized PVC. Very rapid cure. Flexible and fluorescent.

Item #	28419	6 ml tube
	28466	1 liter bottle

Loctite® 3175™ Light Cure Adhesive

A solvent-free adhesive designed for applications where a rapid cure and a dry-to-the-touch surface are required. Excellent for tacking and coating. Good adhesion to plastics.

Item #	29506	1 liter bottle
--------	-------	----------------

Loctite® 3491™ Light Cure Adhesive

A fast curing, medium viscosity adhesive designed for bonding glass-to-glass and to a variety of other surfaces.

Item #	28366	25 ml syringe
	17944	1 liter bottle

Loctite® 3492™ Light Cure Adhesive

A fast curing, low viscosity adhesive designed for bonding glass-to-glass and to a variety of other surfaces.

Item #	28367	25 ml syringe
	18666	1 liter bottle

Loctite® 3554™ / 3555™ / 3556™ Indigo® Visible Light Cure Adhesives

Low, medium and high viscosity adhesives that cure in the visible spectrum, offering properties and performance similar to most UV/visible adhesives. Visible light adhesives cure with unique systems that minimize venting or specialized safety equipment. Benefits include lower initial investment and reduced maintenance costs.

Item #	3554™	1072199	25 ml syringe
	3554™	1072198	1 liter bottle
	3555™	1072221	25 ml syringe
	3555™	1072220	1 liter bottle
	3556™	1072223	25 ml syringe
	3556™	1072222	1 liter bottle

[Continued on Next Page]

Your Source for **BONDING**
LIGHT CURE ADHESIVES

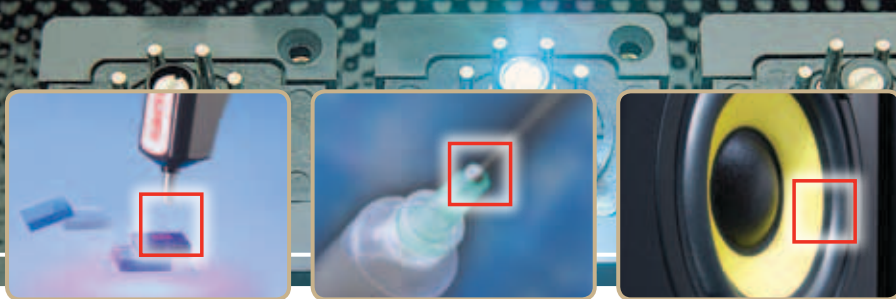

[Acrylic Adhesives Continued]

Loctite® 3494™ Light Cure Adhesive

A durable, UV/visible cure, medium viscosity adhesive designed for glass and metal bonding.

Item # 30765 25 ml syringe
29487 1 liter bottle

Loctite® 3525™ Light Cure Adhesive

A UV/visible cure, high viscosity adhesive. Fast cure, colorless bonds. Excellent flexibility, toughness and durability to moisture exposure. Fluorescent. Used to bond glass, metal and plastics.

Item # 30220 25 ml syringe
30221 1 liter bottle

Loctite® 3526™ Light Cure Adhesive

A UV/visible/heat cure version of Loctite® 3525™ Light Cure Adhesive. All the properties of Loctite® 3525™ plus low temperature, rapid heat-cure capabilities (250°F). Fast cure even under low energy sources. Fluorescent.

Item # 30756 25 ml syringe
30764 1 liter bottle

Loctite® 3974™ Light Cure Adhesive

FLEXIBLE/PLASTIC

A highly resilient, extremely flexible, thermal cycling resistant UV/visible adhesive that bonds most plastics.

Item # 1135733 25 ml syringe
1135732 1 liter bottle

Loctite® 3979™ Light Cure Adhesive

GEL, FLUORESCES RED

NEW

A rapid-curing, UV/visible, non-sag gel, which fluoresces red.

Item # 1402562 25 ml syringe
1402563 300 ml cartridge

[Loctite® Light Cure Adhesives Properties Chart]

	LOCTITE® PRODUCT	ITEM NUMBER	PACKAGE TYPE/SIZE	APPEARANCE, CLARITY & COLOR	CURE TYPE	KEY SUBSTRATES	VISCOSITY (cP), BROOKFIELD, 25°C	ELONGATION AT BREAK (%)	SHORE HARDNESS	TEMPERATURE RANGE	AGENCY APPROVALS
EPOXY ADHESIVES	3336™	31064 31065	42 ml dual syringe 400 ml dual syringe	Clear/ Light Amber	Ultraviolet, room temperature, heat	Metal, thermoplastic	14,500	6	D 79	-65°F (-54°C) to 350°F (176°C)	N/A
	3355™	40792 40793	25 ml syringe 1 liter bottle	Hazy White	Ultraviolet, delay cure	Metal, plastic, glass, ceramic	5,000	11.5	D 77	-65°F (-54°C) to 350°F (176°C)	N/A
CYANOACRYLATES ADHESIVES	4306™ FLASHCURE®	37439 37442*	1 oz. bottle 1 lb. bottle	Clear/ Pale Green	Ultraviolet, visible, moisture	Elastomer, metal, polycarbonate, thermoplastic	20	9	D 72	-65°F (-54°C) to 180°F (82°C)	ISO® 10993 Compliant
	4310™ FLASHCURE®	1401792 1401790	1 oz. bottle 1 lb. bottle	Clear/ Pale Green	Ultraviolet, visible, moisture	Elastomer, metal, polycarbonate, thermoplastic	150	7	D84	-65°F (-54°C) to 180°F (82°C)	ISO® 10993 Compliant
	4311™ FLASHCURE®	1401791 1401789	1 oz. bottle 1 lb. bottle	Clear/ Pale Green	Ultraviolet, visible, moisture	Elastomer, metal, polycarbonate, thermoplastic	900	5	D84	-65°F (-54°C) to 180°F (82°C)	ISO® 10993 Compliant
SILICONE ADHESIVES	5031™ NUVA-SIL®	40086 40087	300 ml cartridge 40 lb. pail	Translucent	Visible, ultraviolet, moisture, acetoxo	Glass, metal, ceramic	5,500	100	A 34	-65°F (-54°C) to 350°F (177°C)	N/A
	5033™ NUVA-SIL®	40088 40089	300 ml cartridge 40 lb. pail	Translucent/ Colorless/ Fluorescent	Visible, ultraviolet, moisture, acetoxo	Glass, metal, ceramic	145 g/min. ¹	170	A 55	-65°F (-54°C) to 350°F (177°C)	N/A
	5039™ NUVA-SIL®	40438 40439	300 ml cartridge 40 lb. pail	Translucent/ Colorless/ Fluorescent	Visible, ultraviolet, moisture, acetoxo	Glass, metal, ceramic	220 g/min. ¹	210	A 37	-65°F (-54°C) to 350°F (177°C)	N/A
	5050™	1212166 1212165	300 ml cartridge 40 lb. pail	Translucent	Ultraviolet	Glass, metal, ceramic	325 g/min. ¹	125	A 45	-65°F (-54°C) to 350°F (177°C)	N/A
	5055™	1212167 1214246 1214247	25 ml syringe 1 liter bottle 15 liter pail	Translucent	Visible, ultraviolet	Glass, metal, ceramic	525	80	A 55	-65°F (-54°C) to 350°F (177°C)	ISO® 10993 Compliant
	5056™	1214249 1214250 1214248	25 ml syringe 1 liter bottle 15 liter pail	Translucent	Visible, ultraviolet	Glass, metal, ceramic, polycarbonate	2,200	170	A 43	-65°F (-54°C) to 350°F (177°C)	ISO® 10993 Compliant
	5083™ NUVA-SIL®	17528 17635	300 ml cartridge 40 lb. pail	Translucent/ Colorless	Ultraviolet, moisture, acetoxo	Glass, metal, ceramic	145 g/min. ¹	170	A 55	-65°F (-54°C) to 350°F (177°C)	N/A
	5091™ NUVA-SIL®	17412 18074	300 ml cartridge 40 lb. pail	Translucent/ Colorless	Ultraviolet, moisture, acetoxo	Glass, metal, ceramic	5,500	100	A 34	-65°F (-54°C) to 350°F (177°C)	UL Classified for U.S.
	5240™ NUVA-SIL®	1010341 1010320 1010343	30 ml syringe 300 ml cartridge 40 lb. pail	Translucent/ White	Visible, ultraviolet, moisture	Glass, metal, ceramic	18,000	270	A 45	-65°F (-54°C) to 350°F (177°C)	ISO® 10993 Compliant

ITEMS IN RED = Source's PICK or NEW

🌐 = Indicates Worldwide Availability

[Loctite® Light Cure Adhesives Properties Chart]

BONDING

Light Cure Adhesives

LOCTITE® PRODUCT	ITEM NUMBER	PACKAGE TYPE/SIZE	APPEARANCE, CLARITY & COLOR	CURE TYPE	KEY SUBSTRATES	VISCOSITY (cP), BROOKFIELD, 25°C	ELONGATION AT BREAK (%)	SHORE HARDNESS	TEMPERATURE RANGE	SHEAR STRENGTH (psi)	
VISIBLE	3554™ INDIGO®	1072199 1072198	25 ml syringe 1 liter bottle	Clear/ Light Yellow	Visible	Polycarbonate, thermoplastic, polyvinyl chloride	300	7	D 77	-65°F (-54°C) to 300°F (149°C)	3,350 ³
	3555™ INDIGO®	1072221 1072220	25 ml syringe 1 liter bottle	Clear/ Light Yellow	Visible	Polycarbonate, thermoplastic, polyvinyl chloride	1,000	10	D 76	-65°F (-54°C) to 300°F (149°C)	2,350 ³
	3556™ INDIGO®	1072223 1072222	25 ml syringe 1 liter bottle	Clear/ Light Yellow	Visible	Polycarbonate, thermoplastic, polyvinyl chloride	5,000	29	D 70	-65°F (-54°C) to 300°F (149°C)	2,900 ³
ULTRAVIOLET/VISIBLE	3100™	19862	25 ml syringe	Slightly Hazy/ Straw	Ultraviolet, visible	Glass, metal, thermoset plastic	6,000	210	D 66	-65°F (-54°C) to 300°F (149°C)	1,670 ²
	3101™	19861	25 ml syringe	Slightly Hazy/ Straw	Ultraviolet, heat, activator	Glass, metal, thermoset plastic	6,000	220	D 66	-65°F (-54°C) to 300°F (149°C)	1,820 ²
	3102™	23690	1 liter bottle	Clear/ Pale Straw	Ultraviolet, visible	Polycarbonate, thermoplastic	3,750	265	D 59	-65°F (-54°C) to 300°F (149°C)	2,291 ¹
	3103™	23691 23692	25 ml syringe 1 liter bottle	Clear/ Pale Straw	Ultraviolet, visible	Polycarbonate, thermoplastic	10,000 Thixotropic	260	D 51	-65°F (-54°C) to 300°F (149°C)	2,849 ³
	3104™	23694 23693	25 ml syringe 1 liter bottle	Clear/ Pale Straw	Ultraviolet, visible	Polycarbonate, thermoplastic, polyvinyl chloride	160	50	D 69	-65°F (-54°C) to 300°F (149°C)	3,155 ³
	3105™	23695 23696	25 ml syringe 1 liter bottle	Clear/ Pale Straw	Ultraviolet, visible	Polycarbonate, thermoplastic, polyvinyl chloride	300	265	D 64	-65°F (-54°C) to 300°F (149°C)	3,640 ³
	3106™	23697 23698	25 ml syringe 1 liter bottle	Clear/ Pale Straw	Ultraviolet, visible	Polycarbonate, thermoplastic, polyvinyl chloride	5,000	250	D 53	-65°F (-54°C) to 300°F (149°C)	3,392 ³
	3107™	28419 28466	6 ml tube 1 liter bottle	Clear/Straw/ Fluorescent	Ultraviolet, visible	Plasticized PVC, thermoplastic	500	220	D 27	-65°F (-54°C) to 300°F (149°C)	783 ⁴
	3494™	30765 29487	25 ml syringe 1 liter bottle	Clear/ Pale Straw	Ultraviolet, visible	Glass, metal	5,500	190	D 65	-65°F (-54°C) to 300°F (149°C)	2,440 ¹
	3525™	30220 30221	25 ml syringe 300 ml cartridge	Clear/ Pale Straw/ Fluorescent	Ultraviolet, visible	Glass, metal, thermoset plastic	15,000	260	D 60	-65°F (-54°C) to 300°F (149°C)	1,480 ¹
	3526™	30756 30764	25 ml syringe 1 liter bottle	Clear/ Pale Straw/ Fluorescent	Ultraviolet, visible, heat	Glass, metal, thermoset plastic	17,800	185	D 62	-65°F (-54°C) to 300°F (149°C)	1,530 ¹
	3974™	1135733 1135732	25 ml syringe 1 liter bottle	Translucent/ Colorless	UV/Visible	Thermoplastic, thermoset plastic	2,800	100	A 70	-65°F (-54°C) to 300°F (149°C)	1,800
	3979™	1402562 1402563	25 ml syringe 1 liter bottle	Translucent/ Straw	UV/Visible	Polycarbonate, polyvinyl chloride	Gel	85	A 50	-65°F (-54°C) to 300°F (149°C)	3,500 ³
ULTRAVIOLET	349™ IMPRUV®	34931 34990	50 ml bottle 1 liter bottle	Clear/Straw	Ultraviolet	Glass, metal	9,500	300	D 70	-65°F (-54°C) to 266°F (130°C)	1,600 ¹
	363™ IMPRUV®	36331 36390	50 ml bottle 1 liter bottle	Clear/ Pale Straw	Ultraviolet	Metal, thermoset plastic	250	88	D 50	-65°F (-54°C) to 356°F (180°C)	1,740 ¹
	3108™	28400 28465	25 ml syringe 1 liter bottle	Translucent/ Colorless	Ultraviolet	Thermoplastic, thermoset plastic	5,100	330	A 72	-65°F (-54°C) to 300°F (149°C)	2,090 ³
	3175™	29506	1 liter bottle	Clear/Straw	Ultraviolet	Various	4,000	14	D 70	-65°F (-54°C) to 300°F (149°C)	370 ¹
	3491™	28366 17944	25 ml syringe 1 liter bottle	Clear/ Pale Straw	Ultraviolet	Glass, metal	1,100	27	D 75	-65°F (-54°C) to 300°F (149°C)	1,450 ¹
	3492™	28367 18666	25 ml syringe 1 liter bottle	Clear/ Pale Straw	Ultraviolet	Glass, metal	500	5	D 79	-65°F (-54°C) to 300°F (149°C)	1,200 ¹
	3493™	28368 18751	25 ml syringe 1 liter bottle	Clear/ Pale Straw	Ultraviolet	Glass, metal	5,500	260	D 75	-65°F (-54°C) to 300°F (149°C)	1,250 ¹
	3751™ LITETAK®	21362 21363	25 ml syringe 1 liter bottle	Clear/ Colorless	Ultraviolet	Various	10,000	50	D 73	-65°F (-54°C) to 275°F (135°C)	700 ³
	3761™ LITETAK®	21359 21360	25 ml syringe 1 liter bottle	Clear/Straw	Ultraviolet	Various	2,500	57	D 69	-65°F (-54°C) to 275°F (135°C)	800 ³
	352™	35241 35286	50 ml bottle 1 liter bottle	Clear/ Light Amber	Ultraviolet, heat, activator	Glass, metal	19,500	290	D 60	-65°F (-54°C) to 275°F (135°C)	2,400 ¹
	366™	36631 12224	50 ml bottle 1 liter bottle	Clear/ Light Amber	Ultraviolet, activator	Glass, metal	7,500	240	D 45	-65°F (-54°C) to 230°F (110°C)	1,450 ¹

ITEMS IN RED = Source's PICK or NEW

 = Indicates Worldwide Availability

* Grit-blasted steel
¹ Grit-blasted steel to glass
³ Polycarbonate to polycarbonate

⁵ Extrusion rate, gram/minute, 1/8 in. orifice at 90 psi
² Etched aluminum
⁴ Polycarbonate to PVC



Your Source for BONDING LIGHT CURE ADHESIVES EQUIPMENT



YOUR EQUIPMENT *Source*

For more details, see the **Loctite® Equipment Sourcebook, LT-3669**, or visit us on the web for additional information, diagrams, products and our full line of equipment at www.equipment.loctite.com.



LOCTITE® PRODUCT		ITEM NUMBER	USED TO DISPENSE	PACKAGE TYPE AND SIZES	MIX RATIOS	VISCOSITY RANGE	TYPE	CONSUMABLES – DISPENSE ACCESSORIES	
SYRINGE DISPENSING									
HANDHELD APPLICATORS		30 ML MANUAL SYRINGE APPLICATOR	98026	Any fluid in 30 ml syringe including 25 ml syringes	30 ml syringe	N/A	Low to High	Manual	Dispense Tips and Accessories – Pages 182-186 Syringe Accessories – Pages 184







LOCTITE® PRODUCT		ITEM NUMBER	TYPE	VISCOSITY RANGE	DISPENSE PATTERNS	USED TO DISPENSE	STROKE ADJUSTMENT	ACTUATION	CONSUMABLES – DISPENSE ACCESSORIES	
GENERAL-PURPOSE APPLICATORS										
HANDHELD VALVES		MANUAL HAND-HELD APPLICATOR	97111	Manual	Low to Medium	Drop, Dot, Bead	Light Cure/Acrylics, Retaining Compounds, Threadlockers	Yes	Finger	Dispense Tips and Accessories – Pages 182-186
		PNEUMATIC HAND-HELD APPLICATOR	97112	Pneumatic	Low to Medium	Drop, Dot, Bead	Light Cure/Acrylics, Retaining Compounds, Threadlockers	Yes	Foot	
		PNEUMATIC HAND-HELD APPLICATOR	97116	Pneumatic	Low to Medium	Drop, Dot, Bead	Light Cure/Acrylics, Retaining Compounds, Threadlockers	Yes	Finger	

LOCTITE® PRODUCT		ITEM NUMBER	TYPE	VISCOSITY RANGE	DISPENSE PATTERNS	USED TO DISPENSE	STROKE ADJUSTMENT	SUCK-BACK	CONSUMABLES – DISPENSE ACCESSORIES	
HIGH PRECISION VALVES										
VALVES & PUMPS		MICRO NEEDLE VALVE	98084	High Precision	Low to Medium	Drop, Dot, Bead, Microdot	Light Cure/Acrylics	Yes	No	Dispense Tips and Accessories – Pages 182-186
	HIGH PERFORMANCE DIAPHRAGM VALVES									
		LIGHT CURE DISPENSE VALVE	98009	High Performance Diaphragm	Low to Medium	Drop, Dot, Bead, Microdot	Light Cure	Yes	No	Dispense Tips and Accessories – Pages 182-186



LOCTITE® BRANDED EQUIPMENT – Loctite® is a full service supplier of equipment and offers a wide variety of equipment services to its customers. **For more Loctite® branded equipment, go to page 171.**



Can't find what you're looking for? Visit www.equipment.loctite.com or call 1-800-LOCTITE (562-8483).

STRAIGHT FROM *The Source*

LOCTITE® PRODUCT		ITEM NUMBER	DISPENSE PATTERNS	USED TO DISPENSE	PACKAGE TYPES & SIZES	VISCOSITY RANGE	VACUUM SUCK-BACK	CONSUMABLES – DISPENSE ACCESSORIES
VOLUMETRIC BOTTLE DISPENSING								
	BENCHTOP PERISTALTIC DISPENSER	98548	Dot, Drop, Bead	Instant Adhesives, Light Cure/Acrylics, Retaining Compounds, Threadlockers	Any	0 to 5,000 cP	N/A	Dispense Tips and Accessories – Pages 182-186
COMPLETE PRESSURE-TIME BOTTLE DISPENSE SYSTEM								
	BOND-A-MATIC® 3000 DISPENSER 0-15 psi	982719	Dot, Drop, Bead	Gel Adhesives, Instant Adhesives, Light Cure/Acrylics, Retaining Compounds, Threadlockers	200 ml bottle 1 lb. bottle 1 liter bottle 2 kg bottle 200 g squeeze tube	Low Medium to High	N/A	Dispense Tips and Accessories – Pages 182-186
	BOND-A-MATIC® 3000 DISPENSER 0-100 psi	982722						
	SHOT MISER™ VALVE CONTROLLER	98079	Dot, Drop, Bead	Instant Adhesives, Light Cure/Acrylics, Retaining Compounds, Threadlockers	250 ml bottle 1 lb. bottle	Low to Medium	N/A	
	SHOT MISER™ DISPENSE VALVE	98085						
	SHOT MISER™ RESERVOIR	98090						
SYRINGE DISPENSING SYSTEMS								
	POSI-LINK™ DISPENSING SYSTEM	See Pg 181	Dot, Drop, Bead	Gel Adhesives, Instant Adhesives, Light Cure/Acrylics, Epoxies	Prepackaged 5 ml syringe 10 ml syringe 25 ml syringe	Low to Paste	Yes	Dispense Tips and Accessories – Pages 182-186
	PRECISION SYRINGE DISPENSING SYSTEM	97006*	Dot, Drop, Bead	Gel Adhesives, Instant Adhesives, Light Cure/Acrylics	3 ml syringe 5 ml syringe 10 ml syringe 30 ml syringe 55 ml syringe	Low to Paste	Yes	Syringes – Page 184
	DIGITAL SYRINGE DISPENSING SYSTEM	883976					Yes	
	FOOT PEDAL DISPENSER	98050*					Yes	

* Syringe Airline Adapter sold separately. Visit www.equipment.loctite.com for all available accessories.

LOCTITE® PRODUCT		ITEM NUMBER	PRESSURE REGULATION	USED TO DISPENSE	PACKAGE TYPE & SIZES	VISCOSITY RANGE	LOW LEVEL SENSING	CONSUMABLES – DISPENSE ACCESSORIES
PNEUMATIC CARTRIDGE DISPENSING								
	300 ML PNEUMATIC CARTRIDGE DISPENSING RETAINER	98319A	0 to 60 psi	Gel Cyanoacrylates, Anaerobic Gasketing, Light Cure/Acrylics, Silicones	300 ml cartridges	Low to Medium	Pneumatic	Cartridge Accessories – Page 183
	PNEUMATIC HANDHELD 300 ML DISPENSER	1294304	0 to 100 psi	Gel Cyanoacrylates, Anaerobic Gasketing, Light Cure/Acrylics, Silicones	300 ml cartridges 250 ml tubes	Medium to High	No	
	300 ML CARTRIDGE PUSHER	98022	0 to 50 psi	Gel Cyanoacrylates, Anaerobic Gasketing, Light Cure/Acrylics, Low Viscosity Silicones	300 ml cartridges 250 ml tubes	Medium	Yes	

LOCTITE® PRODUCT		ITEM NUMBER	PRESSURE REGULATION	USED TO DISPENSE	PACKAGE TYPES & SIZES	VISCOSITY RANGE	LOW LEVEL SENSING	CONSUMABLES – DISPENSE ACCESSORIES
INTEGRATED RESERVOIR CONTROLLERS								
	INTEGRATED SEMI-AUTOMATIC DISPENSER	1390322	0 to 15 psi	Gel Adhesives, Instant Adhesives, Light Cure/Acrylics, Retaining Compounds, Threadlockers	250 ml bottle 1 lb. bottle 1 liter bottle 2 kg bottle 200 g squeeze tube	Low to Medium	No	Dispense Tips and Accessories – Pages 182-186
		1390321	0 to 100 psi			Medium to High	No	
RESERVOIRS								
	BOND-A-MATIC® 3000 RESERVOIR	982720	0 to 15 psi	Gel Adhesives, Instant Adhesives, Light Cure/Acrylics, Retaining Compounds, Threadlockers	250 ml bottle 1 lb. bottle 1 liter bottle 2 kg bottle 200 g squeeze tube	Low to Medium	Yes	Dispense Tips and Accessories – Pages 182-186
		982726					No	
		982723	0 to 100 psi			Medium to High	Yes	
		982727				No		
	SHOT MISER™ RESERVOIR	98090	0 to 100 psi	Instant Adhesives, Light Cure/Acrylics, Retaining Compounds, Threadlockers	250 ml bottle 1 lb. bottle 200 g squeeze tube	Low to High	No	

Your Source for **BONDING** LIGHT CURE ADHESIVES EQUIPMENT

YOUR EQUIPMENT *Source*

For more details, see the **Loctite® Equipment Sourcebook, LT-3669**, or visit us on the web for additional information, diagrams, products and our full line of equipment at www.equipment.loctite.com.



	LOCTITE® PRODUCT	ITEM NUMBER	CONTROLLED OUTPUTS	NUMBER OF DISPENSE VALVES	ADVANCING SLIDE	ROTOSPRAY®	ACCESSORIES
MULTIFUNCTION CONTROLLERS	DUAL CHANNEL AUTOMATIC CONTROLLER	97152	6	2 (Independent)	97118 – 50 mm 97119 – 100 mm	97115	Visit www.equipment.loctite.com for more information on additional accessories.
	DIGITAL MULTIFUNCTIONAL CONTROLLER	1022006	3	3 (Independent)	984691 – 50 mm	In conjunction with Positive Displacement Pump – 983330	
SINGLE FUNCTION CONTROLLERS	DIGITAL DISPENSE CONTROLLER	97101	1	1	N/A	N/A	
	SHOT MISER™ VALVE CONTROLLER	98079	1	1	N/A	N/A	

	LOCTITE® PRODUCT	ITEM NUMBER	LAMP TYPE
LIGHT CURE UV BULB SYSTEMS	ENCLOSED CHAMBER AND FLOOD SYSTEMS		
	UVALOC 1000 UV CURE CHAMBER	805741	1,000-watt Mercury Vapor
	ZETA® 7401 UV CHAMBER	98039	400-watt Metal Halide
	ZETA® 7411-S UV FLOOD SYSTEM	98413	400-watt Metal Halide
	FOCUSED UV FLOOD CURING SYSTEM	1113131	400-watt Metal Halide
	INDIGO® 7418 VISIBLE LIGHT FLOOD SYSTEM	971031	400-watt Visible Arc Lamp
	ZETA® 7420 VISIBLE LIGHT FLOOD SYSTEM	98060 (110 V)	500-watt Visible Arc Lamp

	LOCTITE® PRODUCT	ITEM NUMBER	LAMP TYPE
LIGHT CURE SYSTEMS	CURE CONVEYORS		
	ZETA® 7415 UV BENCHTOP CONVEYOR	98003	300 W/in Electrodeless (sold separately)
	UV BENCHTOP CONVEYOR	1241543	1800-watt Medium Pressure Mercury Arc Lamp
	LIGHT SOURCES		
ELECTRODELESS LAMP ASSEMBLY AND POWER SUPPLY	98004 (208/240 VAC)	300 W/in Electrodeless	
HIGH INTENSITY ULTRAVIOLET SOURCES	980160	1500-watt Medium Pressure Mercury Arc Lamp	

	LOCTITE® PRODUCT	ITEM NUMBER	MEASUREMENT RANGE
LIGHT CURE SYSTEMS	LIGHT METERS		
	UV-BA DOSIMETER-RADIOMETER	1390323	320 to 400 nm
	UV-V DOSIMETER-RADIOMETER	1265282	390 to 600 nm
UV SPOT-7020 RADIOMETER	1406024	280 to 400 nm / 3, 5, and 8 mm light guides	

LOCTITE® BRANDED EQUIPMENT – Loctite® is a full service supplier of equipment and offers a wide variety of equipment services to its customers. **For more Loctite® branded equipment, go to page 171.**
Can't find what you're looking for? Visit www.equipment.loctite.com or call 1-800-LOCTITE (562-8483).

STRAIGHT FROM *The Source*



WEAR EYE PROTECTION

For proper eye protection, use Loctite® brand ultraviolet safety glasses.

Item No. 97210



Item No. 98452

ADDITIONAL RESOURCES

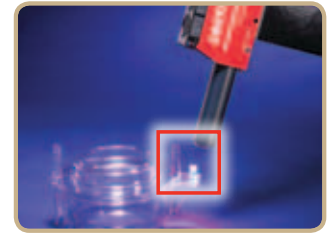
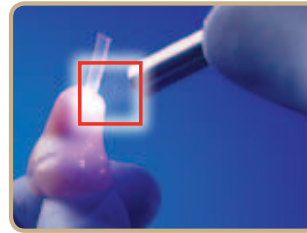

LOCTITE® PRODUCT		ITEM NUMBER	LAMP TYPE	OPTIONS/ACCESSORIES
LED CURING DEVICES				
	7700 LED LIGHT SOURCE II	1427231	LED – 395 nm	OPTIONAL: Timer – 98443; Foot Switch – 98440; Holder – 98522; Dosimeter – 98089; Dosimeter Adapter – 98453
	7703 LED LIGHT SOURCE	98595	LED – Indigo® Wavelength	
	7700-HD LED LIGHT SOURCE II	1427232	LED – 395 nm	
	7703-HD LED LIGHT SOURCE	883979	LED – Indigo® Wavelength	
	LED FLOOD ARRAY – UVA	1167582	LED – 375 nm	Used with 1359255 in conjunction with cable 13333333
	LED FLOOD ARRAY – INDIGO®	1167589	LED – Indigo® Wavelength	Used with 1359255 in conjunction with cable 13333333
	LED FLOOD ARRAY – 405	1167593	LED – 405 nm	Used with 1359255 in conjunction with cable 13333333
	LED FLOOD CONTROLLER	1359255	N/A	Used with all LED Flood Arrays
	CUREJET™ UVA LED	1369539	LED – 375 nm	Used with 1364033 or 1180632
	CUREJET™ 405 LED	1369538	LED – 405 nm	Used with 1364033 or 1180632
	CUREJET™ INDIGO® LED	1369537	LED – Indigo® Wavelength	Used with 1364033 or 1180632
	SINGLE CUREJET™ CONTROLLER	1364033	N/A	Used with all CUREJET™ LEDs
	CUREJET™ QUAD CONTROLLER	1180632	N/A	Used with all CUREJET™ LEDs
WAND SYSTEMS				
	LOCTITE® 100W WAND SYSTEM	1377200	100-watt High Pressure Mercury Arc	ONE OF THE FOLLOWING IS REQUIRED: Light Guide 5 mm x 1,000 mm – Item No. 986377; Light Guide 5 mm x 1,500 mm – Item No. 951681 For other Light Guide options, visit www.equipment.loctite.com .
	ZETA® 760A UV WAND SYSTEM	1329221	200-watt High Pressure Mercury Arc	

LIGHT CURE SYSTEMS

BONDING

Light Cure Adhesives Equipment

Your Source for BONDING ELASTOMERIC ADHESIVES & SEALANTS

- Products with “Flextec® Technology” are based on Henkel’s proprietary polymer backbone
- Exhibit high resiliency while maintaining high tensile strength and good adhesion to many substrates – all without the use of a primer
- Isocyanate and solvent-free, noncorrosive, and compatible with most paint systems
- Begin to cure into a strong thermoset polymer when in contact with ambient moisture
- Ideal for bonding and sealing a multitude of substrates, as well as many applications where silicones cannot be used due to their incompatibility with paint systems



Source's PICK

Loctite® 5510™ Adhesive/Sealant

BLACK, GREY AND WHITE

A multipurpose product based on Flextec® Technology suitable for many adhesive and sealant applications. It offers a fast skin time and cures to a tack-free surface. Its outstanding adhesion and toughness make it ideal for bonding and sealing between dissimilar substrates that are subjected to joint movement or impact.

Item #	1073344	300 ml cartridge	White
	1194277	50 lb. pail	White
	1073346	300 ml cartridge	Grey
	1194276	50 lb. pail	Grey
	1073347	300 ml cartridge	Black
	1197374	50 lb. pail	Black

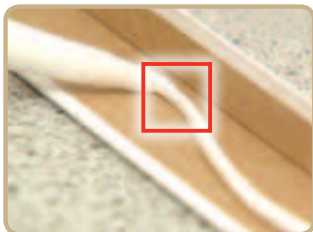
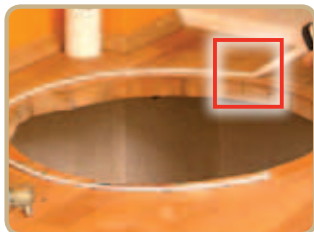

Loctite® 5512™ Adhesive Sealant

High elongation and tensile strength give this product the best of both worlds. This product has good adhesion to many substrates, as well as good impact and peel resistance.

Item #	41380	300 ml cartridge
	41387	5 gallon pail

Source's PICK

Loctite® 5570™ Adhesive

CLEAR AND WHITE

A strong bonding adhesive based on Flextec® Technology with elastic properties for bonding dissimilar substrates. High initial tack and fast setting make it ideal for high productivity applications.

Item #	1073348	300 ml cartridge	White
	1197375	50 lb. pail	White
	1073349	300 ml cartridge	Clear
	1197372	40 lb. pail	Clear

Loctite® 5572™ Adhesive

This product exhibits the highest shear strength on a majority of substrates versus the other products in this line.

Item #	41379	300 ml cartridge
	41386	5 gallon pail

Loctite® 5590™ Adhesive

A two-component adhesive for elastic bonding where the curing rate of one-component adhesives is too slow. The mixed adhesive is non-sag, has high tack and fast set time. The cured product provides durable bonding to a wide variety of substrates.

Item #	1091896	400 ml dual cartridge
--------	---------	-----------------------

FLEXTEC® TECHNOLOGY

Flextec® Technology indicates the use of Henkel's proprietary polymers to formulate outstanding handling and performance into adhesives and sealants. These non-silicone polymers are designed for primerless adhesion, speed and durability in all elastomeric applications.



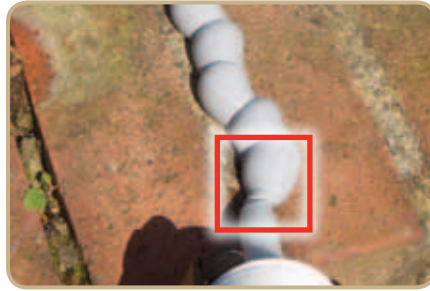
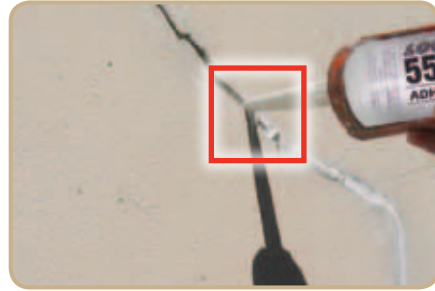

- [Applications]**
- General Assembly
 - Seal Expansion Joints
 - Seal Precast Panels
 - Seal Air or Water Penetration Joints
 - Bond Trim and Molding
 - Bond Roof or Side Panels to Tubular Frames
 - Seal Doors, Windows and Skylights
- [Industries]**
- Seal Wall Penetrations
 - Bond Flooring to Sub-Floor or Metal Frames
 - Seal Siding, Roofing and Gutters
 - Appliances
 - HVAC
 - Signage/Displays
 - General Maintenance
 - Specialty Vehicles
 - Agricultural Vehicles
 - Trailers and Buses
 - Recreational Vehicles
 - Manufactured Housing
 - Metallic or Wooden Construction
- APPLICATIONS & INDUSTRIES**

[Loctite® Elastomeric Adhesives & Sealants Properties Chart]

LOCTITE® PRODUCT	ITEM NUMBER	PACKAGE TYPE/SIZE	COLOR	EXTRUSION RATE** (g/min.)	CURE METHOD	SKIN TIME (min.)	TEMPERATURE RANGE	HARDNESS SHORE A	TENSILE STRENGTH* (psi)	ELONGATION AT BREAK (%)	SHEAR STRENGTH ON STEEL (psi)		
ELASTOMERIC ADHESIVES	5510™	1073344 1194277	300 ml cartridge 50 lb. pail	White	650	Moisture	-40°F (-40°C) to 200°F (93°C)	48	250	320	290		
		1073346 1194276	300 ml cartridge 50 lb. pail	Grey				36				368	240
		1073347 1197374	300 ml cartridge 50 lb. pail	Black				33				376	230
	5512™	41380 41387	300 ml cartridge 5 gallon pail	Black	23	Moisture	8	-40°F (-40°C) to 200°F (93°C)	57	390	500	270	
	5570™	1073348 1197375	300 ml cartridge 50 lb. pail	White	525	Moisture	35	-40°F (-40°C) to 200°F (93°C)	53	380	230	400	
		1073349 1197372	300 ml cartridge 40 lb. pail	Clear	525				20				45
	5572™	41379 41386	300 ml cartridge 5 gallon pail	Black	18	Moisture	12	-40°F (-40°C) to 200°F (93°C)	55	475	225	425	
	5590™	1091896	400 ml dual cartridge	Black	N/A	Two-Component Static Mix	30	-40°F (-40°C) to 200°F (93°C)	60	435	130	290	
5590™ PART A	1091892	5 gallon pail	Black										
5590™ PART B	1091893	5 gallon pail	Black										

ITEMS IN RED = Source's PICK or NEW * Grit-blasted steel. ** Extrusion rate at 73°F, 3.5 mm diameter, 3 bar, for 15 seconds.

Your Source for **BONDING ELASTOMERIC EQUIPMENT**

LOCTITE® PRODUCT	ITEM NUMBER	PRESSURE REGULATION	USED TO DISPENSE	PACKAGE TYPE & SIZES	VISCOSITY RANGE	LOW LEVEL SENSING	CONSUMABLES – DISPENSE ACCESSORIES	
DISPENSE SYSTEMS								
PNEUMATIC CARTRIDGE DISPENSING								
	HIGH PRESSURE 300 ML BENCHTOP CARTRIDGE DISPENSER	1046901	0 to 725 psi	Silicone, Polyurethane, MS Polymer Adhesives	300 ml cartridges	10,000 to 1,000,000 cP	Yes	Use with High Pressure Dispense Valve (sold separately) – see below
	PNEUMATIC HANDHELD 300 ML DISPENSER	1294304	0 to 100 psi	Gel Cyanoacrylates, Anaerobic Gasketing, Light Cure/Acrylics, Silicones	300 ml cartridges 250 ml tubes	Medium to High	No	Cartridge Accessories – Page 183

LOCTITE® PRODUCT	ITEM NUMBER	TYPE	VISCOSITY RANGE	DISPENSE PATTERNS	USED TO DISPENSE	STROKE ADJUSTMENT	SUCK-BACK	CONSUMABLES – DISPENSE ACCESSORIES	
VALVES & PUMPS									
HIGH VISCOSITY FLUID & PASTE VALVES									
	HIGH PRESSURE DISPENSE VALVE – 50 BAR	1049138	High Viscosity Fluid and Paste Valves	10,000 to 1,000,000 cP	Drop, Bead	Silicones, MS Polymers, Urethanes	Yes	Yes	Dispense Tips and Accessories – Pages 182-186
	HIGH PRESSURE DISPENSE VALVE – 150 BAR	1153502	High Viscosity Fluid and Paste Valves	500,000 to 2,000,000 cP	Drop, Bead	Silicones, MS Polymers, Urethanes	Yes	No	Dispense Tips and Accessories – Pages 182-186

Your Source for **BONDING**
SOLVENT-BASED
ADHESIVES

□ To meet tough on-the-job requirements, Loctite® solvent-based aerosol and liquid adhesives provide a combination of:

- Cure speed
- Impact resistance
- Strength
- Temperature range
- Solvent and moisture resistance



Visit the web for an all-access pass to distributors' Safety and Technical Data Sheets, literature, and product application assistance. Or: In U.S., please call 1-800-LOCTITE (562-8483); In Canada, please call 1-800-263-5043.
www.henkelna.com/loctitedistributor
STRAIGHT FROM *The Source*

□ **THE BOND WILL BE INSTANT**
 For faster fixturing of these solvent-based contact adhesives, apply the adhesive to one side of both parts, and allow to breathe for one to two minutes. When the surface starts to appear dry, apply a small additional amount of adhesive to one side and assemble the sides together.

HELPFUL HINTS

[Solvent-Based]

Loctite® Black Contact Adhesive

A professional, solvent-based adhesive with neoprene that blends in with black-colored fabrics, rubbers, weather stripping and other porous materials. Withstands temperature extremes and is resistant to gasoline, kerosene and other solvents. Fast drying and waterproof. Allows repositioning of the parts after initial contact.

Item # 30540 5 fl. oz. tube - Black

Loctite® Contact Adhesive

A fast drying, solvent-based adhesive with neoprene that bonds rubber, insulation, weather stripping and other porous materials. Sets to a tack-free surface in 3-4 minutes, and the early strength is enough to hold most parts together. Allows repositioning of the parts after initial contact.

Item # 30537 5 fl. oz. tube - Yellow

[Spray Adhesives]

Loctite® Maximum Strength Headliner Adhesive

A high strength, aerosol product designed for bonding foam, carpet, fabrics, plastics, rubber, etc. Loctite® Maximum Strength Headliner Adhesive is resistant to extreme seasonal temperatures, is water resistant and sprays on clear.

Item # 37312 16.75 oz. net wt. aerosol

Loctite® All-Purpose Spray Adhesive

Bonds lightweight, porous and non-porous surfaces. Allows for repositionable and permanent bonds. Fast drying: won't shrink or bleed. Resists water and humidity. Contains no ozone-depleting compounds.

Item # 30544 10.5 oz. net wt. aerosol



Sources REVEALED

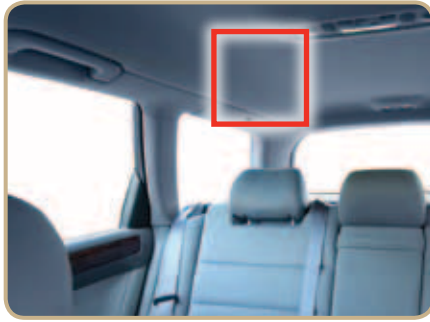

[Applications]

- Carpet
- Foam
- Headliner – Car or Truck

- Interior of Car, Truck or Equipment
- Insulation
- Graphic Arts

APPLICATIONS

BONDING

Solvent-Based Adhesives

[Loctite® Solvent-Based Adhesives Properties Chart]

	LOCTITE® PRODUCT	ITEM NUMBER	PACKAGE TYPE/SIZE	COLOR/APPEARANCE	TEMPERATURE RANGE	FIXTURE/ BOND TIME	FULL CURE	COMMON SURFACES ADHESIVE WILL BOND	AGENCY APPROVALS
SOLVENT-BASED	BLACK CONTACT ADHESIVE	30540	5 fl. oz. tube	Black Gel	Up to 180°F (82°C)	Let breathe 2-3 minutes; sets up in 5-15 minutes.	24 hours at ambient temperature	Weather stripping, vinyl, rubber, wood and metal	CFIA
	CONTACT ADHESIVE	30537	5 fl. oz. tube	Yellow Gel	Up to 180°F (82°C)				CFIA
SPRAY ADHESIVES	MAXIMUM STRENGTH HEADLINER ADHESIVE	37312	16.75 oz. net wt. aerosol	Clear Drying, Semi-translucent Foam	Up to 170°F (77°C)	Let dry 15-20 minutes before assembly. Spray both sides to be bonded for maximum strength.	24 hours at ambient temperature	Foam, carpet, fabrics, plastics and rubber	N/A
	ALL-PURPOSE SPRAY ADHESIVE	30544	10.5 oz. net wt. aerosol	Clear Drying, Semi-translucent Foam	Up to 120°F (49°C)				N/A



Your Source for **BONDING**
MAGNET BONDING
STRUCTURAL ADHESIVES

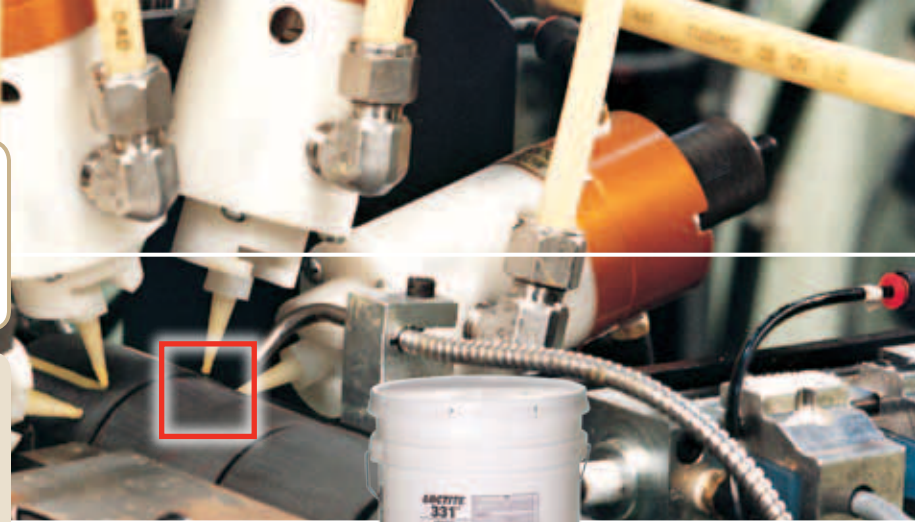

- Combines the benefits of fast process speeds with tough, durable and environmentally resistant bond strengths
- Ideal for bonding ferrite, alnico and neodymium permanent magnets used in electric motors, small engines, speakers, transformers and other devices

[Acid-Free
 Fast Fixture / No-Mixing]

**Loctite® E-214HP™ Hysol®
 Epoxy Adhesive**

OVEN CURE

Single-component, acid-free, heat cure epoxy. Light grey, temperature resistant, high strength, non-sag. Noncorrosive to sensitive parts.

Item #	29339	30 ml syringe
	29340	300 ml cartridge

**Loctite® E-220IC™ Hysol®
 Epoxy Adhesive**

INDUCTION CURE

Single-component, acid-free, epoxy adhesive designed for induction cure operations. A fast curing paste formulated to reduce the risk of localized heating. Well-suited for metal and magnet bonding. Noncorrosive to sensitive parts. Can also be heat cured.

Item #	1078250	30 ml syringe
	1078261*	1 liter bottle

Loctite® 3060™ Structural Adhesive

GAP FILLING

Two-component, acid-free, toughened external-mix acrylic requires no static mixing. Turns green when mixed. Excellent high temperature resistance. Ideal for bonding large metal parts and ferrite or rare earth magnets. Noncorrosive to sensitive parts. Excellent gap filling capability.

Item #	1087985	60 ml kit ⁴
	1087986	1 liter, resin
	1087987	1 liter, activator
	1087988*	10 liter, resin
	1088035*	10 liter, activator

Source's PICK

**Loctite® 331™
 Structural Adhesive**

ULTRA-FAST FIXTURE

Single-component, toughened, activator-cure acrylic. Acid-free, noncorrosive to sensitive parts. Fixtures in 20 seconds and develops full strength in 30 minutes. Excellent high temperature resistance. Ideal for bonding close-fitting metals and magnets.

Item #	1057673	25 ml syringe with manual plunger
	1256398	25 ml EFD syringe
	1057674*	1 liter bottle
	1062124*	10 liter pail

[Fast Fixture / No-Mixing]

**Loctite® 312™ Speedbonder™
 Structural Adhesive**

ULTRA-FAST FIXTURE

Single-component, medium viscosity, activator-cure acrylic. Fixtures in 30 seconds with 75% of full strength developed in 10 minutes. Ideal for bonding a variety of close-fitting parts, including metal, glass and ceramic.

Item #	03333	10 ml kit ²
	00144	50 ml kit ²
	31231	50 ml bottle
	31243	1 liter bottle

**Loctite® 325™ Speedbonder™
 Structural Adhesive**

CHEMICAL RESISTANT

Solvent-resistant, activator-cured acrylic fixtures in minutes. Forms flexible bonds on gaps up to 0.04 in. Designed for severe environments and temperatures to 300°F (149°C).

Item #	32530	50 ml bottle
	32586	1 liter bottle

Loctite® 334™ Structural Adhesive

HIGH TEMPERATURE

Single-component, dual-cure acrylic. Forms tough, flexible bonds on gaps up to 0.02 in. Temperature resistant to 350°F (177°C).

Item #	33403	25 ml syringe
	33470	300 ml cartridge

Source's PICK

Loctite® 392™ Structural Adhesive

TOUGHENED

Single-component, dual-cure acrylic. Provides fast fixture speed and tough, reliable bonds. Can be cured with activator or with heat.

Item #	39205	25 ml syringe with manual plunger
	39250	50 ml tube
	39275	300 ml cartridge
	39280	1 liter bottle

* Made-to-order item.

² 10 ml bottle of Loctite® 312™ Speedbonder™ and 40 g aerosol can of Loctite® 736™ Primer NF™.

³ 50 ml bottle of Loctite® 312™ Speedbonder™ and 6 oz. aerosol can of Loctite® 736™ Primer NF™.

⁴ 2 - 30 ml syringes.

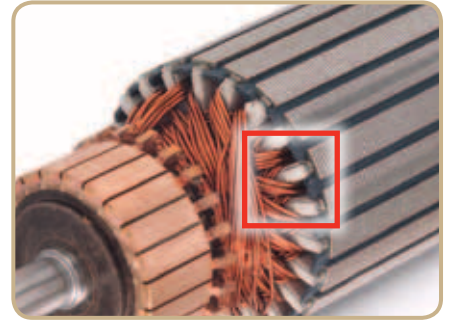

[Applications]

- Ferrite Magnets
- Neodymium Magnets

- Alnico Magnets
- Electric Motors
- Speakers
- Computer Storage Devices

- Small Engines
- Power Hand Tools
- Generators

Source's PICK

Loctite® A-671™ Structural Adhesive
(formerly National Adhesives Bondmaster™ 671)

FAST FIXTURE

Two-component external mix acrylic requires no static mixing. Excellent humidity resistance and gap filling capability.

Item #	1256489	40 ml dual cartridge
	1256488	4000 ml kit
	1256502	2 liter bottle, adhesive
	1255708	2 liter bottle, activator
	1256501	19 liter pail, adhesive
	1255709	19 liter pail, activator

Loctite® A-6750™ Structural Adhesive
(formerly National Adhesives Bondmaster™ 675)

EXTENDED WORK LIFE

Two-component external mix acrylic requires no static mixing. Excellent humidity resistance and gap filling capability. Extended 5-minute work life to allow added time to position parts.

Item #	1256506	40 ml dual cartridge
	1256503	2 liter bottle, adhesive
	1255702	2 liter bottle, activator

[Loctite® Structural Adhesives bond to a variety of substrates]

SUBSTRATE	GALVANIZED	STEEL, ALUMINUM, STAINLESS STEEL	POLYPROPYLENE, UHMW, HDPE, POLYETHYLENE, NYLON, ACETAL	ACRYLIC, POLYCARBONATE, STYRENE, PVC, ABS	FIBERGLASS, POLYESTER OR EPOXY	GLASS, CERAMIC	WOOD, LEATHER, CARDBOARD	MAGNET
GALVANIZED	H8600™, E-50GW™	H8600™, E-50GW™	U-05FL™	H8600™	H8600™	9460™, H8600™, E-50GW	E-50GW™, 9460™, E-20HP™	334™
STEEL, ALUMINUM, STAINLESS STEEL	H8600™	E-30UT™, H8000™, H3151™, 9460™, E-60HP™	3032™	H8000™, U-05FL™	H8000™, H3151™, H3000™, 9460™	9460™, E-20HP™	9460™, E-20HP™	E-214HP™, A-671™, A-6750™
POLYPROPYLENE, UHMW, HDPE, POLYETHYLENE, NYLON, ACETAL	U-05FL™	3032™, U-05FL™	3032™	3032™	3032™	3032™, U-05FL™	Cyanoacrylates or Hot Melt	331™
ACRYLIC, POLYCARBONATE, STYRENE, PVC, ABS	H8600™	H8000™, U-05FL™	3032™	H8000™, H3151™, H3000™	H8000™, H3000™	H8000™	Cyanoacrylates	331™
FIBERGLASS, POLYESTER OR EPOXY	H8600™	H8000™, H3151™, H3000™, 9460™	3032™	H8000™, H3000™	H8000™, H4800™, H3000™, 9460™, E-20HP™, E-30CL™, E-00NS™	9460™, E-20HP™, E-20HP™, E-30CL™, Depend 330™	9460™ E-20HP™	331™
GLASS, CERAMIC	9460™, H8600™, E-50GW™	9460™, E-20HP™	3032™	H8000™	9460™, E-20HP™, E-30CL™, Depend 330™	9460™, E-30CL™, Depend 330™	9460™, E-20HP™, E-00NS™,	312™, 325™
WOOD, LEATHER, CARDBOARD	E-50GW™, 9460™, E-20HP™	9460™, E-20HP™	Cyanoacrylates or Hot Melt	Cyanoacrylates	9460™ E-20HP™	9460™, E-20HP™, E-00NS™,	9460™, E-20HP™, E-00NS™, E-50GW™,	Hot Melt
MAGNET	334™	E-214HP™, A-671™, A-6750™	331™	331™	331™	312™, 325™	Hot Melt	E-220IC™, 392™, 3060™

Please Note: These recommendations should only be used as a starting point. Testing is always recommended. Important! Read substrate specific recommendations first.

Your Source for **BONDING**
MAGNET BONDING
STRUCTURAL ADHESIVES

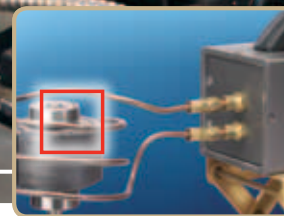

[Loctite® Magnet Bonding Structural Adhesives Properties Chart]

LOCTITE® PRODUCT	ITEM NUMBER	PACKAGE TYPE/SIZE	FEATURES	CHEMISTRY	COLOR	VISCOSITY (cP)	GAP FILL (in.)	FIXTURE TIME	CURE TIME (hrs.)	SHEAR STRENGTH ¹ (psi)	IMPACT STRENGTH ¹ (joules)	TEMPERATURE RESISTANCE	SUGGESTED ACTIVATOR
ACID-FREE FAST FIXTURING / NO MIXING	331™	1057673 1256398 1057674* 1062124*	25 ml syringe w/ manual plunger 25 ml EFD syringe 1 liter bottle 10 liter pail	Ultra-fast Fixture, Acid-free	Two-Step Acrylic	Cream	20,000	0.04	20 seconds	24	3,100	>13	350°F ⁵ (177°C) Loctite® 7387™ or A-534R™ Activator
	3060™	1087985 1087986 1087987 1087988* 1088035*	60 ml kit ⁴ 1 liter, adhesive 1 liter, activator 10 liter, adhesive 10 liter, activator	Room Temperature, Gap Filling, Acid-free	Two-Part External Mix Acrylic	Green	15,000	>0.05	75 seconds	24	4,270	>13	300°F (149°C) N/A
	E-220IC™	1078250 1078261*	30 ml syringe 1 liter bottle	Induction Heat Cure, Acid-free	One-Part Epoxy	Grey	Paste	N/A	N/A	0.03 (induction) 1 (oven)	5,900	>13	300°F (149°C) N/A
	E-214HP™	29339 29340	30 ml syringe 300 ml cartridge	Oven Heat Cure, Acid-free	One-Part Epoxy	Light Grey	Paste	N/A	N/A	2	4,820	N/A	300°F (149°C) N/A
FAST FIXTURING / NO MIXING	312™ SPEEDBONDER™	03333 00144 31231 31243*	10 ml kit ² 50 ml kit ³ 50 ml bottle 1 liter bottle	General-Purpose, Ultra-fast Fixture	Two-Step Acrylic	Clear to Amber	1,000	0.003	30 seconds	24	>2,490	N/A	250°F ⁵ (121°C) Loctite® 736™ Primer NF™
	392™	39205 39250 39275 39280	25 ml syringe 50 ml tube 300 ml cartridge 1 liter bottle	High Toughness, Heat or Activator cure	Two-Step Acrylic	Amber	6,500	0.025	60 seconds	24	2,500	N/A	250°F ⁵ (121°C) Loctite® 7387™ or A-534R™ Activator
	334™	33403 33470	25 ml syringe 300 ml cartridge	Severe Environment, High Temperature	Two-Step Acrylic	Yellow	80,000	0.02	90 seconds	24	2,800	5.2	350°F ⁵ (177°C) Loctite® 7387™ Activator or 7380™
	325™ SPEEDBONDER™	32530 32586	50 ml bottle 1 liter bottle	Severe Environment, Chemical Resistant	Two-Step Acrylic	Clear Brown	20,000	0.04	5 minutes	24	1,595	N/A	300°F ⁵ (149°C) Loctite® 7075™ Activator or 7387™
	A-671™	1256489 1256488 1256502 1255708 1256501 1255709	40 ml dual cartridge 4000 ml kit, adhesive/activator 2 liter bottle, adhesive 2 liter bottle, activator 19 liter pail, adhesive 19 liter pail, activator	Gap Filling, Humidity Resistant, Fast Fixture	Two-Part External Mix Acrylic	Green	30,000	0.1	30-60 seconds	1	2,500-3,000	8-10	311°F (155°C) N/A
	A-6750™	1256506 1256503 1255702	40 ml dual cartridge 2 liter bottle, adhesive 2 liter bottle, activator	Extended Working Time, Large Gaps	Two-Part External Mix Acrylic	Green	30,000	0.2	10-13 minutes	3	2,500-3,000	8-10	311°F (155°C) N/A

ITEMS IN RED = Source's PICK or NEW

* Made-to-order item. ² 10 ml bottle of Loctite® 312™ Speedbonder™ and 40 g aerosol can of Loctite® 736™ Primer NF™. ³ 50 ml bottle of Loctite® 312™ Speedbonder™ and 6 oz. aerosol can of Loctite® 736™ Primer NF™. ⁴ 2 - 30 ml syringes. ⁵ Product is heat aged at temperature and tested at 72°F (22°C). Product maintained ≥ 75% of its initial strength.

Your Source for **BONDING** **MAGNET BONDING** **EQUIPMENT**

YOUR EQUIPMENT *Source*

For more details, see the **Loctite® Equipment Sourcebook, LT-3669**, or visit us on the web for additional information, diagrams, products and our full line of equipment at www.equipment.loctite.com.

LOCTITE® PRODUCT		ITEM NUMBER	USED TO DISPENSE	PACKAGE TYPE & SIZES	MIX RATIOS	VISCOSITY RANGE	TYPE	CONSUMABLES – DISPENSE ACCESSORIES	
SYRINGE DISPENSING									
	30 ML MANUAL SYRINGE APPLICATOR	98026	Any fluid in 30 ml syringe (25 ml of adhesive)	30 ml syringe	N/A	Low to High	Manual	Dispense Tips and Accessories – Pages 182-186 Syringe Accessories – Pages 184	
	30 ML SYRINGE MANUAL PLUNGERS	98193	Any fluid in 30 ml syringe	30 ml syringe (3 pack)	N/A	Low to High	Manual	N/A	
TWO-PART DISPENSING									
HANDHELD APPLICATORS		98472	Two-Component Epoxies, Urethanes, Methacrylates	50 ml dual cartridge	1:1, 2:1, 4:1	Low to High	Manual	Static Mix Nozzles and Accessories – Pages 185-186	
		1034026		S-50 dual cartridge	10:1				
		97042	Two-Component Epoxies, Urethanes, Methacrylates	50 ml dual cartridge	1:1, 2:1, 10:1	Low to High	Pneumatic		
		98466	Two-Component Epoxies, Urethanes, Methacrylates	50 ml dual cartridge	1:1, 2:1	Low to High	Manual		
		98415			10:1				
		200 ML / 400 ML DUAL CARTRIDGE MANUAL APPLICATORS	983436	Two-Component Epoxies, Urethanes, Methacrylates	200 ml dual cartridge	1:1, 2:1	High to Paste		Manual
			983438		400 ml dual cartridge	1:1, 2:1			
			985246		490 ml dual cartridge	10:1			
		200 ML / 400 ML DUAL CARTRIDGE PNEUMATIC APPLICATORS	983437	Two-Component Epoxies, Urethanes, Methacrylates	200 ml dual cartridge	1:1, 2:1	High to Paste		Pneumatic
			983439		400 ml dual cartridge	1:1, 2:1			
985249			490 ml dual cartridge		10:1				
	UNIVERSAL FIXMASTER® DISPENSER	1372751	Two-Component Epoxies, Urethanes, Methacrylates	200 ml and 400 ml dual cartridges	1:1, 2:1, 4:1, 10:1	High to Paste	Manual		

ITEMS IN RED = *Source's* **PICK** or **NEW**

LOCTITE® BRANDED EQUIPMENT – Loctite® is a full service supplier of equipment and offers a wide variety of equipment services to its customers. **For more Loctite® branded equipment, go to page 171.**

Can't find what you're looking for? Visit www.equipment.loctite.com or call 1-800-LOCTITE (562-8483).

STRAIGHT FROM *The Source*

Your Source for **BONDING** **METAL BONDING** **STRUCTURAL ADHESIVES**



- Specially formulated to provide tough, long-lasting bonds to metal surfaces, such as steel, galvanized steel, aluminum, sheet metal and stainless steel
- Capable of reducing or replacing the need for threaded fasteners, welds or rivets, resulting in a higher quality assembly

[General Performance]

Loctite® H3151™ Speedbonder™ Structural Adhesive

EXTENDED OPEN TIME

Extended open time allows for adjustment of parts. Excellent bond strength on aluminum and steel. Impact- and peel-resistant.

Item #	83015	50 ml dual cartridge
	83014	400 ml dual cartridge

Loctite® H4500™ Speedbonder™ Structural Adhesive

FAST FIXTURE

High strength structural adhesive for metals. Fixtures in 15 minutes. Now with mix color indication.

Item #	996512	50 ml dual cartridge
	83041	490 ml dual cartridge

**NEW
Improved
Formula**

Loctite® H4710™ Speedbonder™ Structural Adhesive

CORROSION RESISTANT – FAST FIXTURE

Non-sagging, room temperature curing methacrylate adhesive designed for structural bonding of galvanized and galvanneal parts. Excellent environmental resistance. Fills gaps up to 0.375 in. Delivers excellent peel and impact strength with no surface preparation.

Item #	1056941	50 ml dual cartridge
	39317	490 ml dual cartridge

Loctite® H4720™ Speedbonder™ Structural Adhesive

CORROSION RESISTANT – EXTENDED WORK LIFE

Maintains superior strength in corrosive environments. Excellent general-purpose metal bonder.

Item #	1296594	50 ml dual cartridge
	913475	490 ml dual cartridge

[High Temperature / Chemical Resistant]

Loctite® E-20NS™ Hysol® Epoxy Adhesive

NON-SAG

A light tan, non-sag, high peel, high shear epoxy with a 20-minute work life. Excellent choice for bonding stainless steel, bronze and copper.

Item #	29334	50 ml cartridge
	29335	200 ml dual cartridge
	29336	400 ml dual cartridge

Loctite® E-60HP™ Hysol® Epoxy Adhesive

TOUGHENED

A high strength epoxy with a 60-minute work life. Off-white, high peel and shear strength.

Item #	29319	50 ml dual cartridge
	29321	400 ml dual cartridge
	29322*	5 gallon pail, resin
	29323*	5 gallon pail, hardener

Loctite® E-214HP™ Hysol® Epoxy Adhesive

HIGH STRENGTH

A grey, one-component, heat cure epoxy; temperature resistant.

Item #	29339	30 ml syringe
	29340	300 ml cartridge

Loctite® 9432NA™ Hysol® Epoxy Adhesive

HIGH TEMPERATURE

A grey, one-component paste, heat cure epoxy. Excellent high temperature performance, excellent chemical resistance.

Item #	83217*	2 lb. can
	83216	55 lb. pail

Loctite® H8700™ Speedbonder™ Structural Adhesive

WELD-THROUGH CAPABLE

A weld-through capable, toughened, two-component acrylic adhesive designed for weld/rivet reduction. Exhibits high resistance to paint bake temperatures.

Item #	1064166	50 ml dual cartridge
	1064321	400 ml dual cartridge

Source's PICK

Source's PICK

* Made-to-order item.



[Applications]

- Sign Assembly
- Attaching Front, Side and Top Panels to Specialty Vehicle Frames

- Garage Door Assembly
- Assembly of Tub/Spa to Metal Frame
- Commercial Furniture

[Galvanized Bonding]

Loctite® E-50GW™ Hysol® Epoxy Adhesive

GALVANIZED STEEL TO WOOD BONDER

A grey, two-component epoxy designed to bond galvanized steel to wooden surfaces. Extended, 50-minute work life makes for easy adjustment of larger parts.

Item #	1078249	50 ml dual cartridge
	1077864*	400 ml dual cartridge

[Steel Bonding]

Loctite® H8500™ Speedbonder™ Structural Adhesive

FAST FIXTURE

Excellent peel strength on steel and aluminum. Contains 30 mil spacer beads to prevent excessive squeeze-out of adhesive due to over-clamping.

Item #	996514	50 ml dual cartridge
	827608	490 ml dual cartridge
	40888*	5 gallon pail, activator
	40889*	5 gallon pail, adhesive

[Aluminum Bonding]

Loctite® H8000™ Speedbonder™ Structural Adhesive

MEDIUM FIXTURE

Non-sag, room temperature curing, methacrylate adhesive exhibits superior peel strength on multiple substrates, especially aluminum.

Item #	996453	50 ml dual cartridge
	36160	490 ml dual cartridge
	35939*	35 lb. pail, adhesive
	35940*	45 lb. pail, activator

Source's PICK

Loctite® H8600™ Speedbonder™ Structural Adhesive

MEDIUM WORK LIFE

Excellent shear strength on steel and aluminum. Especially designed for severe environments.

Item #	40875	50 ml dual cartridge
	38762	400 ml dual cartridge
	38760*	5 gallon pail, adhesive
	38761*	5 gallon pail, activator

Loctite® H8610™ Speedbonder™ Structural Adhesive

FAST FIXTURE

A fast curing, acrylic designed for bonding galvanized steel, galvaneal and galvalum. Excellent shear strength on steel and aluminum. Especially designed for long-term heat and humidity resistance.

Item #	1055263	50 ml dual cartridge
	1055839	400 ml dual cartridge

[Heat Cure]

Loctite® 3984™ Hysol® Epoxy Adhesive

HIGH PERFORMANCE

Highly fluorescent, one-part, heat cure epoxy adhesive offering superior physical, environmental and performance properties.

Item #	36768	30 ml syringe
	37299*	1 liter bottle

Loctite® H8510™ Speedbonder™ Structural Adhesive

EXTENDED WORK LIFE

Offers superior peel and impact strength on steel and aluminum. This grey, ultra-fracture toughened, acrylic adhesive has an extended open time, making it ideal for the assembly and adjustment of larger parts. Contains 30 mil spacer beads to prevent excessive squeeze-out of adhesive due to over-clamping.

Item #	996513	50 ml dual cartridge
	1107651	490 ml dual cartridge

[Flexible Bonding]

Loctite® U-05FL™ Hysol® Urethane Adhesive

HIGH STRENGTH

A two-part, high performance urethane adhesive for metal bonding with a 5-minute work life. Off-white, highly flexible, impact and moisture resistant, high peel, high shear.

Item #	29348	50 ml dual cartridge
	29349	200 ml dual cartridge
	29350	400 ml dual cartridge
	29351	5 gallon pail, resin
	29352	5 gallon pail, hardener

Loctite® H8010™ Speedbonder™ Structural Adhesive

GAP CONTROL

Non-sag, room temperature curing, methacrylate adhesive exhibits superior peel strength on multiple substrates, especially aluminum. Contains 0.010 in. spacer beads to prevent excessive squeeze-out of adhesive due to over-clamping.

Item #	1056929	50 ml dual cartridge
	40594*	490 ml dual cartridge

Loctite® H8100™ Speedbonder™ Structural Adhesive

FAST FIXTURE

Exhibits excellent peel and shear strength on aluminum.

Item #	1056942	50 ml dual cartridge
	1056943	490 ml dual cartridge

Loctite® H8110™ Speedbonder™ Structural Adhesive

ULTRA-FAST FIXTURE

Aluminum bonder fixtures in 5 minutes.

Item #	1371355	50 ml dual cartridge
	1371361	490 ml dual cartridge

* Made-to-order item

Your Source for **BONDING**
METAL BONDING
STRUCTURAL ADHESIVES

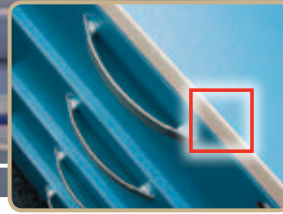

[**Loctite® Metal Bonding Structural Adhesives Properties Chart**]

LOCTITE® PRODUCT	ITEM NUMBER	PACKAGE TYPE/SIZE	FEATURES	CHEMISTRY	COLOR	VISCOSITY (cP)	MIX RATIO	WORK LIFE (min.)	FIXTURE TIME (min.)	CURE TIME (hrs.)	SHEAR STRENGTH (psi)	IMPACT STRENGTH ² (Joules)	PEEL STRENGTH ¹ (pli)	HOT STRENGTH ² (psi)	
GENERAL PERFORMANCE	H4710™ SPEEDBONDER™	1056941 39317	50 ml dual cartridge 490 ml dual cartridge	Fast Set, Corrosion-Resistant	Two-Part Acrylic	Grey	70,000	10:1	9 ⁵	15	24	1,800 ¹ 4,180 ⁴	>14	16	540
	H4720™ SPEEDBONDER™	1296594 913475	50 ml dual cartridge 490 ml dual cartridge	Extended Work Life, Corrosion-Resistant	Two-Part Acrylic	Teal	70,000	10:1	75 ⁵	100	24	4,200 ¹	8.5	25.3	1,100
	H4500™ SPEEDBONDER™	996512 83041	50 ml dual cartridge 490 ml dual cartridge	Fast Fixture	Two-Part Acrylic	Grey	45,000	10:1	15 ⁵	15	24	3,100 ¹	11.5	10.7	950
	H3151™ SPEEDBONDER™	83015 83014	50 ml dual cartridge 400 ml dual cartridge	Extended Work Life	Two-Part Acrylic	Light Yellow	70,000	1:1	60	120	24	3,800 ¹	7.7	15 ⁴	900
HIGH TEMPERATURE / CHEMICAL RESISTANT	E-20NS™ HYSOL®	29334 29335 29336	50 ml cartridge 200 ml dual cartridge 400 ml dual cartridge	Low Sag	Two-Part Epoxy	Tan	60,000	2:1	20	150	24	2,790 ³	1.5	N/A	1,120
	E-60HP™ HYSOL®	29319 29321 29322* 29323*	50 ml dual cartridge 400 ml dual cartridge 5 gallon pail, resin 5 gallon pail, hardener	High Performance	Two-Part Epoxy	Off-White	47,000	2:1	60	240	24	4,320 ³	Not Tested	Not Tested	430 ⁵
	E-214HP™ HYSOL®	29339 29340	30 ml cartridge 300 ml cartridge	High Strength	One-Part Epoxy	Grey	Paste	N/A	N/A	N/A	0.66 @ 218°F (120°C)	4,820 ³	Not Tested	Not Tested	3,172 ⁵
	9432NA™ HYSOL®	83217* 83216*	2 lb. can 55 lb. pail	High Temperature	One-Part Epoxy	Grey	225,000	One-Part	N/A	N/A	0.5 @ 248°F (120°C)	3,000 ⁴	2.7	N/A	300
	H8700™ SPEEDBONDER™	1064166 1064321	50 ml dual cartridge 400 ml dual cartridge	Weld-Through Capable	Two-Part Acrylic	Blue	40,000	2:1	40 ⁵	40 ¹	24	2,175 ¹ 2,870 ⁴	>14	7 ⁴	435
GALVANIZED BONDING	H8610™ SPEEDBONDER™	1055263 1055839	50 ml dual cartridge 400 ml dual cartridge	Fast Fixture	Two-Part Acrylic	White	105,000	2:1	11 ⁵	20	24	1,800 ¹ 4,180 ⁴	>14	10	500
	H8600™ SPEEDBONDER™	40875 38762 38760* 38761*	50 ml dual cartridge 400 ml dual cartridge 5 gallon pail, adhesive 5 gallon pail, activator	Medium Work Life	Two-Part Acrylic	Blue	86,000	2:1	25	55	24	3,355 ¹	13.1 ⁶	35 ⁵	≥1,800 ⁶
	E-50GW™ HYSOL®	1078249 1077864	50 ml dual cartridge 400 ml dual cartridge	Extended Work Life	Two-Part Epoxy	Grey	37,000	4:1	50	>180	24	1,900 ⁶	N/A	N/A	1,270 (500 hrs.)
STEEL BONDING	H8500™ SPEEDBONDER™	996514 827608 40888* 40889*	50 ml dual cartridge 490 ml dual cartridge 5 gallon pail, activator 5 gallon pail, adhesive	Fast Fixture	Two-Part Acrylic	Grey	60,000	10:1	25 ⁵	25	24	2,175 ¹ 2,180 ⁴	>14	92	960
	H8510™ SPEEDBONDER™	996513 1107651	50 ml dual cartridge 490 ml dual cartridge	Extended Work Life	Two-Part Acrylic	Grey	45,000	10:1	30 ⁵	30	24	2,175 ¹ 1,900 ⁴	>14	58	540
ALUMINUM BONDING	H8000™ SPEEDBONDER™	996453 36160 35939* 35940*	50 ml dual cartridge 490 ml dual cartridge 35 lb. pail, adhesive 45 lb. pail, activator	Medium Work Life	Two-Part Acrylic	Green	190,000	10:1	30 ⁵	30	24	2,800 ¹ 3,140 ⁴	>42	45	450
	H8010™ SPEEDBONDER™	1056929 40594	50 ml dual cartridge 490 ml dual cartridge	Gap Control	Two-Part Acrylic	Grey	200,000	10:1	35 ⁵	40	24	2,175 ¹ 2,800 ⁴	29	37 ⁴	435
	H8100™ SPEEDBONDER™	1056942 1056943	50 ml dual cartridge 490 ml dual cartridge	Fast Fixture	Two-Part Acrylic	Green	190,000	10:1	15 ⁵	20	24	2,880 ¹ 3,070 ⁴	11	12 ⁴	560
	H8110™ SPEEDBONDER™	1371355 1371361	50 ml dual cartridge 490 ml dual cartridge	Ultra-Fast Fixture	Two-Part Acrylic	Green	200,000	10:1	7 ⁸	5	24	1,360 ¹	8	9	N/A
FLEXIBLE BONDING	U-05FL™ HYSOL®	29348 29349 29350 29351 29352	50 ml dual cartridge 200 ml dual cartridge 400 ml dual cartridge 5 gallon pail, resin 5 gallon pail, hardener	High Strength, Flexible	Two-Part Urethane	Off-White	100,000	1:2	5	180	24	930 ³	N/A	N/A	280
HEAT CURE	3984™ HYSOL®	36768 37299*	30 ml syringe 1 liter bottle	High Performance	One-Part Epoxy	Light Grey	25,000	One Part	N/A	N/A	25 min. @ 212°F (100°C)	>2,000 ³	2.0	N/A	200

ITEMS IN RED = Source's PICK or NEW

* Made-to-order item.

² 220°F (104°C) shear on steel.

⁵ Etched aluminum.

⁸ Work life = time for viscosity to double;

¹ Steel.

³ Grit-blasted steel.

⁶ Galvanized steel.

Working time = maximum time before assembly (steel).

⁴ Aluminum.

⁷ Abraded and etched aluminum.

[Loctite® Structural Adhesives bond to a variety of substrates]

SUBSTRATE	GALVANIZED	STEEL, ALUMINUM, STAINLESS STEEL	POLYPROPYLENE, UHMW, HDPE, POLYETHYLENE, NYLON, ACETAL	ACRYLIC, POLYCARBONATE, STYRENE, PVC, ABS	FIBERGLASS, POLYESTER OR EPOXY	GLASS, CERAMIC	WOOD, LEATHER, CARDBOARD	MAGNET
GALVANIZED	H8600™, E-50GW™	H8600™, E-50GW™	U-05FL™	H8600™	H8600™	9460™, H8600™, E-50GW	E-50GW™, 9460™ E-20HP™	334™
STEEL, ALUMINUM, STAINLESS STEEL	H8600™	E-30UT™, H8000™, H3151™, 9460™, E-60HP™	3032™	H8000™, U-05FL™	H8000™, H3151™, H3000™, 9460™	9460™, E-20HP™	9460™, E-20HP™	E-214HP™, A-671™, A-6750™
POLYPROPYLENE, UHMW, HDPE, POLYETHYLENE, NYLON, ACETAL	U-05FL™	3032™, U-05FL™	3032™	3032™	3032™	3032™	Cyanoacrylates or Hot Melt	331™
ACRYLIC, POLYCARBONATE, STYRENE, PVC, ABS	H8600™	H8000™, U-05FL™	3032™	H8000™, H3151™, H3000™	H8000™, H3000™	H8000™	Cyanoacrylates	331™
FIBERGLASS, POLYESTER OR EPOXY	H8600™	H8000™, H3151™, H3000™, 9460™	3032™	H8000™, H3000™	H8000™, H4800™, H3000™, 9460™, E-20HP™, E-20HP™, E-00NS™	9460™, E-20HP™, E-30CL™, 330™ Depend®	9460™ E-20HP™	331™
GLASS, CERAMIC	9460™, H8600™, E-50GW™	9460™, E-20HP™	3032™, U-05FL™	H8000™	9460™, E-20HP™, E-30CL™, 330™ Depend®	9460™, E-30CL™, 330™ Depend®	9460™, E-20HP™, E-00NS™	312™, 325™
WOOD, LEATHER, CARDBOARD	E-50GW™, 9460™, E-20HP™	9460™, E-20HP™	Cyanoacrylates or Hot Melt	Cyanoacrylates	9460™ E-20HP™	9460™, E-20HP™, E-00NS™	9460™, E-20HP™, E-00NS™, E-50GW™	Hot Melt
MAGNET	334™	E-214HP™, A-671™, A-6750™	331™	331™	331™	312™, 325™	Hot Melt	E-220IC™, 392™, 3060™

Please Note: These recommendations should only be used as a starting point. Testing is always recommended. Important! Read substrate specific recommendations first.

Your Source for **BONDING METAL BONDING EQUIPMENT**



LOCTITE® PRODUCT	ITEM NUMBER	USED TO DISPENSE	PACKAGE TYPE & SIZES	MIX RATIOS	VISCOSITY RANGE	TYPE	CONSUMABLES – DISPENSE ACCESSORIES		
TWO-PART DISPENSING									
HANDHELD APPLICATORS		50 ML DUAL CARTRIDGE MANUAL APPLICATORS	98472	Two-Component Epoxies, Urethanes, Methacrylates	50 ml dual cartridge	1:1, 2:1, 4:1	Low to High	Static Mix Nozzles & Accessories – Pages 185-186	
			1034026		S-50 dual cartridge	10:1			
		50 ML DUAL CARTRIDGE PNEUMATIC APPLICATOR	97042	Two-Component Epoxies, Urethanes, Methacrylates	50 ml dual cartridge	1:1, 2:1, 10:1	Low to High		Pneumatic
			CAULKING GUN CONVERSION KITS FOR 50 ML CARTRIDGES	98466	Two-Component Epoxies, Urethanes, Methacrylates	50 ml dual cartridge	1:1, 2:1		Low to High
			98415			10:1			
		200 ML/400 ML DUAL CARTRIDGE MANUAL APPLICATORS	983436	Two-Component Epoxies, Urethanes, Methacrylates	200 ml dual cartridge	1:1, 2:1	High to Paste		Manual
			983438		400 ml dual cartridge	1:1, 2:1			
			985246		490 ml dual cartridge	10:1			
		200 ML/400 ML DUAL CARTRIDGE PNEUMATIC APPLICATORS	983437	Two-Component Epoxies, Urethanes, Methacrylates	200 ml dual cartridge	1:1, 2:1	High to Paste		Pneumatic
			983439		400 ml dual cartridge	1:1, 2:1			
985249				490 ml dual cartridge	10:1				
	UNIVERSAL FIXMASTER® DISPENSER	1372751	Two-Component Epoxies, Urethanes, Methacrylates	200 ml and 400 ml dual cartridges	1:1, 2:1, 4:1, 10:1	High to Paste	Manual		

ITEMS IN RED = Source's PICK or NEW

LOCTITE® BRANDED EQUIPMENT – Loctite® is a full service supplier of equipment and offers a wide variety of equipment services to its customers. For more Loctite® branded equipment, go to page 171. Can't find what you're looking for? Visit www.equipment.loctite.com or call 1-800-LOCTITE (562-8483).

STRAIGHT FROM The Source

Your Source for **BONDING**
MULTIPLE
SURFACE BONDING
STRUCTURAL ADHESIVES



- Bonds a wide variety of materials, such as metal, ceramic and plastic
- Available in a variety of formulations and performance capabilities, including fast cure, superior water/humidity resistance, ease of dispense, excellent hot strength, and a resistance to a wide range of chemicals

[Clear Bonding]

Loctite® 0151™ Hysol® Epoxy Adhesive

EXTENDED WORK LIFE

A general-purpose, thixotropic paste epoxy with a 60-minute work life, that allows for adjustment of large parts.

Item #	83069	50 ml dual cartridge
	83176	EPK 3.3 oz. kit
	83179	2.6 lb. kit
	83178	10.7 lb. kit

Loctite® 608™ Hysol® Epoxy Adhesive

FAST FIXTURE

A fast setting, low odor epoxy with a 5-minute work life. Cures at room temperature to form a clear bond line.

Item #	83086	4 g foil pack
	83075	50 ml dual cartridge
	83082	EPK 2.8 oz. kit

Loctite® E-00CL™ Hysol® Epoxy Adhesive

FLOWABLE

A clear, flowable, fast-setting epoxy with a 5-minute work life.

Item #	29289	50 ml dual cartridge
	29290	200 ml dual cartridge
	29291	400 ml dual cartridge

Loctite® E-05MR™ Hysol® Epoxy Adhesive

MOISTURE RESISTANT

Clear, fast fixturing epoxy that provides excellent moisture resistance and exceptional toughness. Non-skinning properties make bulk dispensing possible.

Item #	1086598	50 ml dual cartridge
	1086600*	200 ml dual cartridge
	1086599*	400 ml dual cartridge
	1087602*	5 gallon pail, resin
	1087603*	5 gallon pail, hardener

Source's PICK **Loctite® E-30CL™ Hysol® Epoxy Adhesive**

CHEMICAL RESISTANT

An ultra-clear, low viscosity, impact resistant epoxy with a 30-minute work life. An excellent glass bonder. Exhibits exceptional chemical resistance.

Item #	29329	50 ml dual cartridge
	29330	200 ml dual cartridge
	29331	400 ml dual cartridge
	29332*	5 gallon pail, resin
	29333*	5 gallon pail, hardener

[No Mix / Small Gap]

Loctite® A-533™ Structural Adhesive
(formerly National Adhesives Bondmaster™ 533)

ULTRA-FAST FIXTURE

A general-purpose adhesive for bonding magnets, metals and glass. Fixtures in seconds. Use with Loctite® A-534R™ Activator.

Item #	1254145	50 ml bottle
	1254144	1 liter bottle
	1254143	14 liter pail

Loctite® 326™ Speedbonder™ Structural Adhesive

FAST FIXTURE

An all-purpose bonder. Offers the strength of an epoxy and the speed of an instant adhesive. Solvent resistant. Ideal for applications requiring fast fixturing. Use with Loctite® 7649™ Primer N™.

Item #	32629	50 ml bottle
	32685	1 ml bottle

Source's PICK **Loctite® 330™ Depend® Adhesive**

GENERAL-PURPOSE

A general-purpose, high viscosity adhesive for a wide range of materials, including metal, wood, ferrite, ceramic and plastic. Use with Loctite® 7387™ Depend® Activator.

Item #	20253	3 ml kit ¹
	20251	25 ml kit ²
	20252	250 ml kit ³
	33058	250 ml tube
	33064	300 ml cartridge
	33081	1 liter bottle

* Made-to-order item.
¹ Contains 2.5 ml tube of Loctite® 330™ Depend® Adhesive and 0.6 ml ampule of Loctite® 7387™ Depend® Activator.
² Contains 25 ml syringe of Loctite® 330™ Depend® Adhesive and 25 g aerosol can of Loctite® 7387™ Depend® Activator.
³ Contains 250 ml tube of Loctite® 330™ Depend® Adhesive and 128 g of Loctite® 7387™ Depend® Activator.

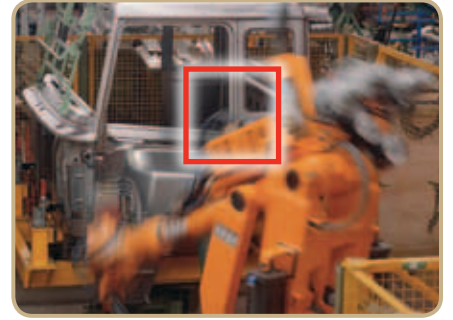
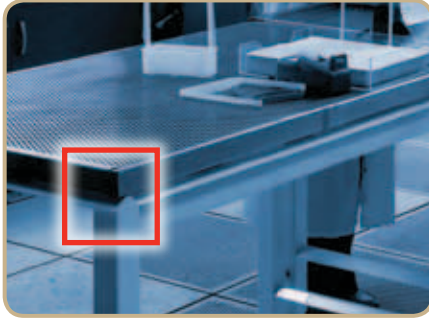

[Industries]

- Machining and Tooling
- Recreational Vehicles
- Furniture

- Structural Building Components
- Appliance

[Sandable]

**Loctite® 615™ Hysol®
Epoxy Adhesive**

MACHINABLE

A high strength, low odor epoxy with a 10-minute work life. Blue, fast cure, gap filling.

Item #	83094	EPK 3.2 oz kit
	83095*	24 lb. kit

**Loctite® E-90FL™ Hysol®
Epoxy Adhesive**

IMPACT RESISTANT

A grey, impact-resistant, toughened epoxy with a 90-minute work life.

Item #	29309	50 ml dual cartridge
	29310	200 ml dual cartridge
	29311	400 ml dual cartridge

**Loctite® E-30UT™ Hysol®
Epoxy Adhesive**

ULTRA-TOUGH

Room temperature curing epoxy which contains Kevlar® to provide exceptional fracture toughness characteristics for the most demanding structural bonding requirements with a 35-minute work life.

Item #	1078234	50 ml dual cartridge
	1078235	400 ml dual cartridge

[Flexible Bonding]

Source's PICK

**Loctite® E-05CL™ Hysol®
Epoxy Adhesive**

FAST FIXTURE

A clear, flexible, high peel, low odor epoxy with a 3-minute work life.

Item #	29299	50 ml dual cartridge
	29300	200 ml dual cartridge
	29301	400 ml dual cartridge
	29302*	5 gallon pail, resin
	29303*	5 gallon pail, hardener

[High Toughness]

**Loctite® 324™ Speedbonder™
Structural Adhesive**

FAST FIXTURE

Ideal for larger gap applications. Offers the strength of an epoxy and the speed of an instant adhesive. Solvent resistant. Fixtures in minutes. Specially formulated for toughness and impact strength. Use with Loctite® 7075™ or A-534R Activator.

Item #	32430	50 ml bottle
	32490	1 liter bottle

**Loctite® 9430™ Hysol®
Epoxy Adhesive**

IMPACT RESISTANT

An off-white, toughened, high peel, high shear strength epoxy with a 50-minute work life.

Item #	83114	2 lb. kit
	83113	10 lb. kit

**Loctite® E-40FL™ Hysol®
Epoxy Adhesive**

TOUGHENED

A grey, impact resistant, toughened epoxy with a 40-minute work life.

Item #	29304	50 ml dual cartridge
	29305	200 ml dual cartridge
	29306	400 ml dual cartridge

Source's PICK

**Loctite® E-20HP™ Hysol®
Epoxy Adhesive**

HIGH PERFORMANCE

A high strength epoxy with a 20-minute work life. Off-white, toughened, high peel, high shear.

Item #	29314	50 ml dual cartridge
	29315	200 ml dual cartridge
	29316	400 ml dual cartridge
	29317	5 gallon pail, resin
	29318	5 gallon pail, hardener

**Loctite® 9460™ Hysol®
Epoxy Adhesive**

NON-SAG

A grey, impact-resistant, high viscosity, high peel, high shear epoxy with a 50-minute work life.

Item #	83129	50 ml dual cartridge
	83128	200 ml dual cartridge
	83127	400 ml dual cartridge
	83131	5 lb. kit
	83130	20 lb. kit
	83133	50 lb. pail, hardener
	83134	50 lb pail, resin

Your Source for **BONDING**
MULTIPLE
SURFACE BONDING
STRUCTURAL ADHESIVES

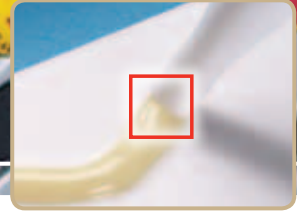
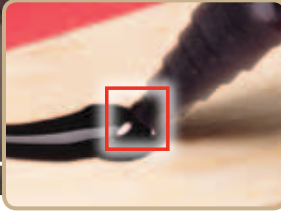

**Loctite® 9462™ Hysol®
Epoxy Adhesive**

HIGH STRENGTH

A beige, toughened epoxy with a 55-minute work life. Its medium viscosity, 1:1 mix ratio, and non-sag features make it very easy to apply. Excellent impact resistance for bonding a variety of surfaces, including metal, plastic and wood.

- Item # 83142 50 ml dual cartridge
- 83135* 200 ml dual cartridge

**Loctite® E-60HP™ Hysol®
Epoxy Adhesive**

FLOWABLE

A high strength epoxy with a 60-minute work life. Off-white, high peel, high shear.

- Item # 29319 50 ml dual cartridge
- 29321 400 ml dual cartridge
- 29322* 5 gallon pail, resin
- 29323* 5 gallon pail, hardener

Source & PICK

**Loctite® 3981™ Hysol®
Epoxy Adhesive**

FLUORESCENT

Highly fluorescent, one-component, heat cure epoxy adhesive offers superior physical, environmental and performance properties.

- Item # 36766 30 ml syringe
- 37297 1 liter bottle

**Loctite® 3985™ Hysol®
Epoxy Adhesive**

WIRE BONDING

A one-component, heat cure epoxy. Ideal for bonding wires to motor armatures.

- Item # 40870 1 liter bottle
- 34731* 5 gallon pail

**Loctite® E-7570™ Epoxy Adhesive
(formerly National Adhesives Eccobond® G-757)**

LOW TEMPERATURE RESISTANT

A one-component, heat cure epoxy, exhibiting excellent impact resistance at low temperatures.

- Item # 1386228 25 ml syringe
- 1215379 1 gallon pail
- 1215380 5 gallon pail

**[High Temperature /
Chemical Resistant]**

**Loctite® 332™
Structural Adhesive**

NO MIX/SMALL GAP

An activator-cured, no-mix adhesive that provides temperature resistance up to 400°F (204°C). Use with Loctite® 7387™ Depend® Activator.

- Item # 33201 25 ml syringe with manual plunger
- 33275 300 ml cartridge
- 33290 1 liter bottle

[Loctite® Structural Adhesives bond to a variety of substrates]

SUBSTRATE	GALVANIZED	STEEL, ALUMINUM, STAINLESS STEEL	POLYPROPYLENE, UHMW, HDPE, POLYETHYLENE, NYLON, ACETAL	ACRYLIC, POLYCARBONATE, STYRENE, PVC, ABS	FIBERGLASS, POLYESTER OR EPOXY	GLASS, CERAMIC	WOOD, LEATHER, CARDBOARD	MAGNET
GALVANIZED	H8600™, E-50GW™	H8600™, E-50GW™	U-05FL™	H8600™	H8600™	9460™, H8600™, E-50GW	E-50GW™, 9460™ E-20HP™	334™
STEEL, ALUMINUM, STAINLESS STEEL	H8600™	E-30UT™, H8000™, H3151™, 9460™, E-60HP™, E-04SS™	3032™	H8000™, U-05FL™	H8000™, H3151™, H3000™, 9460™	9460™, E-20HP™	9460™, E-20HP™	E-214HP™, A-671™, A-6750™
POLYPROPYLENE, UHMW, HDPE, POLYETHYLENE, NYLON, ACETAL	U-05FL™	3032™, U-05FL™	3032™	3032™	3032™	3032™	Cyanoacrylates or Hot Melt	331™
ACRYLIC, POLYCARBONATE, STYRENE, PVC, ABS	H8600™	H8000™, U-05FL™	3032™	H8000™, H3151™, H3000™	H8000™, H3000™	H8000™	Cyanoacrylates	331™
FIBERGLASS, POLYESTER OR EPOXY	H8600™	H8000™, H3151™, H3000™, 9460™	3032™	H8000™, H3000™	H8000™, H4800™, H3000™, 9460™, E-20HP™, E-30CL™, E-00NS™, 330™ Depend®	9460™, E-20HP™, E-20HP™, E-30CL™, 330™ Depend®	9460™ E-20HP™	331™
GLASS, CERAMIC	9460™, H8600™, E-50GW™	9460™, E-20HP™	3032™	H8000™	9460™, E-20HP™, E-30CL™, 330™ Depend®	9460™, E-30CL™, 330™ Depend®	9460™, E-20HP™, E-00NS™	312™, 325™
WOOD, LEATHER, CARDBOARD	E-50GW™, 9460™, E-20HP™	9460™, E-20HP™	Cyanoacrylates or Hot Melt	Cyanoacrylates	9460™ E-20HP™	9460™, E-20HP™, E-00NS™, E-50GW™	9460™, E-20HP™, E-00NS™, E-50GW™	Hot Melt
MAGNET	334™	E-214HP™, A-671™, A-6750™	331™	331™	331™	312™, 325™	Hot Melt	E-220IC™, 392™, 3060™

Please Note: These recommendations should only be used as a starting point. Testing is always recommended. **Important!** Read substrate specific recommendations first.

* Made-to-order item

Source's PICK

Loctite® 1C™ Hysol® Epoxy Adhesive

GAP FILLING

A high viscosity epoxy with a 25-minute work life. Excellent gap filling capability.

Item #	1373425	EPK 4 oz. kit
	1377650	4 lb. kit
	1377344	17 lb. kit
	1377777*	60 lb. pail, resin
	1377391*	46 lb. pail, hardener

Loctite® 9340™ Hysol® Epoxy Adhesive

NON-SAG

A grey, high viscosity epoxy with a 90-minute work life. Excellent high temperature and chemical resistance.

Item #	83104	EPK 2.7 oz. kit
	83105	5 lb. kit

Loctite® E-40HT™ Hysol® Epoxy Adhesive

HIGH TEMPERATURE

A toughened epoxy that combines high peel strength at room temperature and high tensile lap shear strength at elevated temperatures.

Item #	1086065	50 ml dual syringe
	1086081	400 ml dual cartridge

Loctite® E-50CR™ Hysol® Epoxy Adhesive

CHEMICALLY RESISTANT

A flowable epoxy with excellent chemical resistance. Black, 50-minute work life.

Item #	1079594	50 ml dual syringe
	1079593	400 ml dual cartridge

Loctite® 9459™ Hysol® Epoxy Adhesive

SELF-LEVELING

A one-component, heat cure epoxy. Low viscosity, self-leveling. Light grey, excellent high temperature performance and excellent chemical resistance.

Item #	83126*	10 lb. can
--------	--------	------------

[Loctite® Multiple Surface Bonding Structural Adhesives Properties Chart]

	LOCTITE® PRODUCT	ITEM NUMBER	PACKAGE TYPE/SIZE	FEATURES	CHEMISTRY	COLOR	VISCOSITY (cP)	MIX RATIO	WORK LIFE (minutes)	FIXTURE TIME (minutes)	CURE TIME (hours)	SHEAR STRENGTH ¹ (psi)	TEMPERATURE RESISTANCE
POTTING	U-09LV™ HYSOL®	38588 38589	50 ml dual cartridge 200 ml dual cartridge	Medium Work Life, Low Viscosity	Two-Part Urethane	Clear	1,000	1:1	10	>180	24	1,146	122°F (50°C)
	E-60NC™ HYSOL®	29324 29325 29326 29327* 29328*	50 ml dual cartridge 200 ml dual cartridge 400 ml dual cartridge 5 gallon pail, resin 5 gallon pail, hardener	Extended Work Life, Noncorrosive	Two-Part Epoxy	Black	8,000	1:1	60	>180	24	2,630	250°F (121°C)
FLEXIBLE BONDING	E-05CL™ HYSOL®	29299 29300 29301 29302* 29303*	50 ml dual cartridge 200 ml dual cartridge 400 ml dual cartridge 5 gallon pail, resin 5 gallon pail, hardener	Fast Fixture	Two-Part Epoxy	Clear	2,500	1:1	3	30	24	1,430	250°F (121°C)
	E-40FL™ HYSOL®	29304 29305 29306	50 ml dual cartridge 200 ml dual cartridge 400 ml dual cartridge	Medium Fixture	Two-Part Epoxy	Opaque Grey	70,000	1:1	40	180	24	640	250°F (121°C)
	E-90FL™ HYSOL®	29309 29310 29311	50 ml dual cartridge 200 ml dual cartridge 400 ml dual cartridge	Extended Work Life	Two-Part Epoxy	Opaque Grey	40,000	1:1	90	>180	24	810	250°F (121°C)

ITEMS IN RED = Source's PICK or NEW

* Made-to-order item.
¹ Grit-blasted steel.

Your Source for **BONDING**
MULTIPLE
SURFACE BONDING
STRUCTURAL ADHESIVES



[Loctite® Multiple Surface Bonding Structural Adhesives Properties Chart]

	LOCTITE® PRODUCT	ITEM NUMBER	PACKAGE TYPE/SIZE	FEATURES	CHEMISTRY	COLOR	VISCOSITY (cP)	MIX RATIO	WORK LIFE (minutes)	FIXTURE TIME	CURE TIME (hours)	SHEAR STRENGTH ¹ (psi)	TEMPERATURE RESISTANCE
NO MIX / SMALL GAP	A-533™ ^{2,3}	1254145 1254144	50 ml bottle 1 liter bottle	Ultra-Fast Fixture	Two-Step Acrylic	Transparent Blue	15,000	N/A	N/A	15-30 sec.	24	3,500	325°F ³ (163°C)
	326™ SPEEDBONDER™ ^{2,3}	32629 32685	50 ml bottle 1 ml bottle	Fast Fixture	Two-Step Acrylic	Light Amber	17,000	N/A	N/A	1 min.	24	2,200	250°F ³ (121°C)
	330™ DEPEND® ⁴	20253 20251 20252 33058 33064 33081	3 ml kit ⁴ 25 ml kit ⁶ 250 ml kit ⁶ 250 ml tube 300 ml cartridge 1 liter bottle	General-Purpose	Two-Step Acrylic	Pale Yellow	67,500	N/A	N/A	5 min.	24	3,300	250°F ³ (121°C)
CLEAR BONDING	D609™ HYSOL®	83089	50 ml dual cartridge	Fast Fixture UV Resistant	Two-Part Epoxy	Clear	15,000	1:1	5	15 min.	24	2,970	180°F (82°C)
	E-00CL™ HYSOL®	29289 29290 29291	50 ml dual cartridge 200 ml dual cartridge 400 ml dual cartridge	Fast Fixture Flowable	Two-Part Epoxy	Clear	10,000	1:1	5	15 min.	24	2,160	180°F (82°C)
	E-05MR™ HYSOL®	1086598 1086600* 1086599* 1087602* 1087603*	50 ml dual cartridge 200 ml dual cartridge 400 ml dual cartridge 5 gallon pail, resin 5 gallon pail, hardener	Moisture Resistant	Two-Part Epoxy	Ultra-Clear	25,000	1:1	5	15 min.	24	3,380	250°F (121°C)
	608™ HYSOL®	83086 83075 83082	4 g foil pack 50 ml dual cartridge EPK 2.8 oz. kit	Fast Fixture Non-Sag	Two-Part Epoxy	Clear	100,000	1:1	5	15 min.	24	2,980	130°F (82°C)
	E-00NS™ HYSOL®	29294 29295 29296	50 ml dual cartridge 200 ml dual cartridge 400 ml dual cartridge	Fast Fixture Low Odor	Two-Part Epoxy	Translucent	100,000	1:1	3	15 min.	24	3,000	180°F (82°C)
	E-30CL™ HYSOL®	29329 29330 29331 29332* 29333*	50 ml dual cartridge 200 ml dual cartridge 400 ml dual cartridge 5 gallon pail, resin 5 gallon pail, hardener	Medium Work Life, Chemical Resistant	Two-Part Epoxy	Clear	10,000	2:1	30	>180 min.	24	3,100	250°F (121°C)
	0151™ HYSOL®	83069 83176 83179 83178 83181* 83180*	50 ml dual cartridge EPK 3.3 oz. kit 2.6 lb. kit 10.7 lb. kit 40 lb. pail, resin 6.8 lb. can, hardener	Extended Work Life	Two-Part Epoxy	Clear	60,000	2.7:1	60	>180 min.	24	2,675	160°F (121°C)

ITEMS IN RED = Source's PICK
 or NEW

= Indicates Worldwide Availability

* Made-to-order item.
¹ Grit-blasted steel.
² Block grit-blasted mild steel.
³ Etched aluminum.
⁴ Contains 2.5 ml tube of Loctite® 330™ Depend® Adhesive and 0.6 ml ampule of Loctite® 7387™ Depend® Activator.
⁵ Contains 25 ml syringe of Loctite® 330™ Depend® Adhesive and 25 g aerosol can of Loctite® 7387™ Depend® Activator.
⁶ Contains 250 ml tube of Loctite® 330™ Depend® Adhesive and 128 g of Loctite® 7387™ Depend® Activator.
⁷ Formerly National Adhesives Product. See product description for more details.
⁸ Product is heat aged at temperature and tested at 72°F (22°C). Product maintained ≥ 75% of its initial strength.
⁹ Use with Loctite® A-534R™ Activator.
¹⁰ Use with Loctite® 7649 Primer N™.
¹¹ Use with Loctite® 7387™ Depend® Activator.
¹² Use with Loctite® 7075™ Activator.

[Loctite® Multiple Surface Bonding Structural Adhesives Properties Chart]

LOCTITE® PRODUCT	ITEM NUMBER	PACKAGE TYPE/SIZE	FEATURES	CHEMISTRY	COLOR	VISCOSITY (cP)	MIX RATIO	WORK LIFE (minutes)	FIXTURE TIME (minutes)	CURE TIME (hours)	SHEAR STRENGTH ¹ (psi)	TEMPERATURE RESISTANCE
324™ SPEEDBONDER™ 	32430 32490	50 ml bottle 1 liter bottle	No Mix/ Small Gap	Two-Step Acrylic	Amber	17,000	N/A	N/A	5	24	3,600	350°F ³ (177°C)
E-30UT™ HYSOL®	1078234 1078235	50 ml dual cartridge 400 ml dual cartridge	Ultra-Tough	Two-Part Epoxy	Purple	12,200	2:1	30	180	24	4,200	250°F (121°C)
E-20HP™ HYSOL®	29314 29315 29316 29317 29318	50 ml dual cartridge 200 ml dual cartridge 400 ml dual cartridge 5 gallon pail, resin 5 gallon pail, hardener	Easy Mix	Two-Part Epoxy	Off-White	30,000	2:1	20	120	24	3,270	250°F (121°C)
9460™ HYSOL®	83129 83128 83127 83131 83130 83133 83134	50 ml dual cartridge 200 ml dual cartridge 400 ml dual cartridge 5 lb. kit 20 lb. kit 50 lb. pail, hardener 50 lb pail, resin	Non-Sag	Two-Part Epoxy	Grey	200,000	1:1	50	>180	24	3,500 ²	250°F (121°C)
9430™ HYSOL®	83114 83113	2 lb. kit 10 lb. kit	Impact Resistant	Two-Part Epoxy	Off-White	12,000	3.78:1	50	>180	24	4,230	180°F (82°C)
E-60HP™ HYSOL®	29319 29321 29322* 29323*	50 ml dual cartridge 400 ml dual cartridge 5 gallon pail, resin 5 gallon pail, hardener	High Performance	Two-Part Epoxy	Off-White	45,000	2:1	60	>180	24	4,320	250°F (121°C)
9462™ HYSOL®	83142 83135*	50 ml dual cartridge 200 ml dual cartridge	High Strength	Two-Part Epoxy	Beige	70,000	1:1	50	>180	24	4,180	250°F (121°C)
3981™ HYSOL®	36766 37297	30 ml syringe 1 liter bottle	Flowable Heat Cure	One-Part Epoxy	Transparent Yellow	5,000	N/A	N/A	N/A	0.5 @ 257°F (125°C)	4,930	250°F (121°C)
3985™ HYSOL®	40870 34731*	1 liter bottle 5 gallon pail	Non-Sag Heat Cure	One-Part Epoxy	Black	50,000	N/A	N/A	N/A	0.5 @ 272°F (133°C)	N/A	N/A
E-7570™	1386228 1215379 1215380	25 ml syringe 1 gallon pail 5 gallon pail	Low Temperature Impact Resistance	One-Part Epoxy	Grey	Paste	N/A	N/A	N/A	0.66 @ 275°F (135°C)	1,500 ³	250°F (121°C)
332™⁴	33201 33275 33290	25 ml syringe with manual plunger 300 ml cartridge 1 liter bottle	No Mix/ Small Gap	Two-Step Acrylic	Amber	100,000	N/A	N/A	3	24	3,000	400°F ³ (204°C)
1C™ HYSOL®	1373425 1377344 1377777* 1377391*	EPK 4 oz. kit 17 lb. kit 60 lb. pail, resin 46 lb. pail, hardener	Gap Filling	Two-Part Epoxy	Off-White	350,000	2.5:1	25	210	24	1,500 ³	250°F (121°C)
E-40HT™ HYSOL®	1086065 1086081	50 ml dual syringe 400 ml dual cartridge	High Strength	Two-Part Epoxy	Off-White	430,000	2:1	45	180	24	4,030 ³	300°F (149°C)
E-50CR™ HYSOL®	1079594 1079593	50 ml dual syringe 400 ml dual cartridge	Flowable	Two-Part Epoxy	Black	18,000	2:1	50	300	24	2,500 ³	250°F (121°C)
9340™ HYSOL®	83104 83105	EPK 2.7 oz. kit 5 lb. kit	Non-Sag	Two-Part Epoxy	Grey	Paste	1:1	90	>180	24	2,300 ³	>180°F (82°C)
9459™ HYSOL®	83126	10 lb. can	Self-Leveling Heat Cure	One-Part Epoxy	Light Grey	40,000	N/A	N/A	N/A	1 @ 250°F (121°C)	3,000 ³	>300°F (149°C)
615™ HYSOL®	83094 83095*	EPK 3.2 oz. kit 24 lb. kit	Fast Fixture	Two-Part Epoxy	Light Blue	200,000	1:1	10	25	24	3,825	250°F (121°C)

ITEMS IN RED = Source's PICK
or NEW

 = Indicates Worldwide Availability

* Made-to-order item.

¹ Grit-blasted steel.

² Block grit-blasted mild steel.

³ Etched aluminum.

⁴ Contains 0.2 fl. oz. tube of Loctite® 330™ Depend® Adhesive and 0.7 fl. oz. ampule of Loctite® 7387™ Depend® Activator.

⁵ Contains 25 ml syringe of Loctite® 330™ Depend® Adhesive and 25 g aerosol can of Loctite® 7387™ Depend® Activator.

⁶ Contains 250 ml tube of Loctite® 330™ Depend® Adhesive and .128 g ampule of Loctite® 7387™ Depend® Activator.

⁷ Formerly National Adhesives Product. See product description for more details.

⁸ Product is heat aged at temperature and tested at 72°F (22°C). Product maintained ≥ 75% of its initial strength.

⁹ Use with Loctite® A-534R™ Activator.

¹⁰ Use with Loctite® 7649 Primer N™.

¹¹ Use with Loctite® 7387™ Depend® Activator.

¹² Use with Loctite® 7075™ Activator.

Your Source for **BONDING**
PLASTIC / COMPOSITE BONDING STRUCTURAL ADHESIVES



- Bonds a wide variety of materials, such as fiberglass, gelcoat, thermoplastics, polycarbonate, ABS, PVC, polyethylene and polypropylene
- Specially formulated to provide UV resistance, high impact resistance and peel resistance

[General Bonding]

Loctite® E-04SS™ Epoxy Adhesive

SEAM SEALING

A fast fixturing adhesive and sealer. Stainless steel color matched for use in appliance industry.

Item #	902242	400 ml dual cartridge
	901428*	46 lb. pail, hardener
	901426*	50 lb. pail, resin

Loctite® H3000™ Speedbonder™ Structural Adhesive

HIGH STRENGTH

A low viscosity adhesive which exhibits high bond strength on a variety of substrates.

Item #	83001	50 ml dual cartridge
	83000	400 ml dual cartridge

Loctite® H3300™ Speedbonder™ Structural Adhesive

FAST FIXTURE

A non-sag, fast fixturing structural adhesive for bonding a variety of substrates.

Item #	83020	50 ml dual cartridge
	83019	400 ml dual cartridge
	83024*	40 lb. pail, adhesive
	83022*	40 lb. pail, activator

Loctite® H5004™ Speedbonder™ Structural Adhesive

(formerly National Adhesives Bondmaster® V5004)

LOW ODOR/CLEAR

A low odor, low viscosity adhesive, cures to a transparent color. Ultra-fast, this adhesive fixtures in 3 minutes.

Item #	1384596	50 ml dual cartridge
--------	---------	----------------------

Loctite® U-09FL™ Hysol® Urethane Adhesive

FLEXIBLE

A two-part, high performance urethane adhesive for plastic bonding with a 10-minute work life. Clear, impact resistant, high peel.

Item #	29460	50 ml dual cartridge
	29461*	200 ml dual cartridge
	29462*	400 ml dual cartridge

Source's PICK

Loctite® H3101™ Speedbonder™ Structural Adhesive

MEDIUM WORK LIFE

A medium viscosity structural adhesive ideal for bonding a variety of substrates.

Item #	83007	50 ml dual cartridge
	83006	400 ml dual cartridge

[High Toughness]

Loctite® H4100™ Speedbonder™ Structural Adhesive

ULTRA-FAST FIXTURE

A non-sagging adhesive ideal for bonding PVC, polycarbonate, acrylic, ABS and FRP. Develops handling strength in 3-5 minutes. Forms resilient bonds and maintains its strength over a wide range of temperatures.

Item #	83032	490 ml dual cartridge
--------	-------	-----------------------

Loctite® H4200™ Speedbonder™ Structural Adhesive

FAST FIXTURE

A plastic and composite bonder with high peel and impact resistance. Fixtures in 15 minutes.

Item #	83038	490 ml dual cartridge
--------	-------	-----------------------

Loctite® H4000™ Speedbonder™ Structural Adhesive

NON-SAG

A medium fixturing structural adhesive for bonding various plastic and composite substrates, including epoxy coat and glass fiber-reinforced polyester.

Item #	83025	490 ml dual cartridge
--------	-------	-----------------------

Source's PICK

Loctite® H4800™ Speedbonder™ Structural Adhesive

TOUGHENED

Excellent peel and impact resistant. Provides high bond strengths on composites.

Item #	996515	50 ml dual cartridge
	83045	490 ml dual cartridge
	83047*	40 lb. pail, adhesive
	83046*	36 lb. pail, activator

Loctite® H6051™ Speedbonder™ Structural Adhesive

UV RESISTANCE

A white, UV-resistant adhesive ideal for bonding and sealing gel-coated parts. Excellent non-sagging properties.

Item #	83062	490 dual cartridge
	83065	38 lb. pail, adhesive
	83063	60 lb. pail, activator

* Made-to-order item

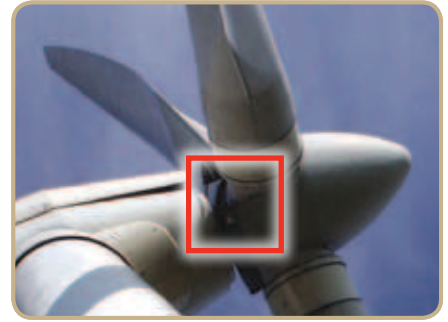

[Industries]

- Tub and Spa
- Marine

- Wind Turbine Blade
- Recreational Vehicle

Loctite® E-120HP™ Hysol® Epoxy Adhesive

ULTRA-STRENGTH

An amber, non-sag, aerospace grade epoxy with an extended open time to allow for large parts adjustment.

- Item # 29353 50 ml dual cartridge
- 29354 200 ml dual cartridge
- 29355 400 ml dual cartridge
- 29356* 5 gallon pail, resin
- 29357* 5 gallon pail, hardener

Loctite® E-119HP™ Hysol® Epoxy Adhesive

NON-WICKING

One-component, heat cure epoxy exhibits very low wicking during cure when exposed to elevated cure temperatures. A thixotropic, non-sag, beige paste that bonds extremely well to carbon fiber composite and aluminum materials.

- Item # 1078992 30 ml syringe
- 1080008* 300 ml cartridge

[Polyolefin Bonding]

Loctite® 3032™ Structural Adhesive

FAST FIXTURE

A fast fixturing, thixotropic acrylic adhesive. Designed to bond low energy plastic substrates. Excellent polypropylene bonder.

- Item # 1051591 50 ml dual cartridge
- 40760* 490 ml dual cartridge

Loctite® 3982™ Hysol® Epoxy Adhesive

FLUORESCENT

Highly fluorescent, one-component, heat cure epoxy offering superior physical, environmental and performance properties.

- Item # 36767 30 ml syringe

Loctite® E-910™ Epoxy Adhesive (formerly National Adhesives Eccobond® 910-22)

LOW CURE TEMPERATURE

One-component, heat-cure epoxy can be cured at low temperatures, making it ideal for bonding most plastics.

- Item # 1219191 25 g syringe
- 1215342 5 gallon pail

Loctite® 3034™ Structural Adhesive

TOUGHENED

Extended open time allows for adjustment of parts. Excellent peel and shear strength on polyethylene plastics.

- Item # 1051330 50 ml cartridge
- 960973 490 ml dual cartridge

[Loctite® Structural Adhesives bond to a variety of substrates]

SUBSTRATE	GALVANIZED	STEEL, ALUMINUM, STAINLESS STEEL	POLYPROPYLENE, UHMW, HDPE, POLYETHYLENE, NYLON, ACETAL	ACRYLIC, POLYCARBONATE, STYRENE, PVC, ABS	FIBERGLASS, POLYESTER OR EPOXY	GLASS, CERAMIC	WOOD, LEATHER, CARDBOARD	MAGNET
GALVANIZED	H8600™, E-50GW™	H8600™, E-50GW™	U-05FL™	H8600™	H8600™	9460™, H8600™, E-50GW	E-50GW™, 9460™, E-20HP™	334™
STEEL, ALUMINUM, STAINLESS STEEL	H8600™	E-30UT™, H8000™, H3151™, 9460™, E-60HP™	3032™	H8000™, U-05FL™	H8000™, H3151™, H3000™, 9460™	9460™, E-20HP™	9460™, E-20HP™	E-214HP™, A-671™, A-6750™
POLYPROPYLENE, UHMW, HDPE, POLYETHYLENE, NYLON, ACETAL	U-05FL™	3032™, U-05FL™	3032™	3032™	3032™	3032™	Cyanoacrylates or Hot Melt	331™
ACRYLIC, POLYCARBONATE, STYRENE, PVC, ABS	H8600™	H8000™, U-05FL™	3032™	H8000™, H3151™, H3000™	H8000™, H3000™	H8000™	Cyanoacrylates	331™
FIBERGLASS, POLYESTER OR EPOXY	H8600™	H8000™, H3151™, H3000™, 9460™	3032™	H8000™, H3000™	H8000™, H4800™, H3000™, 9460™, E-20HP™, E-30CL™, E-00NS™	9460™, E-20HP™, E-20HP™, E-30CL™, 330™ Depend®	9460™ E-20HP™	331™
GLASS, CERAMIC	9460™, H8600™, E-50GW™	9460™, E-20HP™	3032™	H8000™	9460™, E-20HP™, E-30CL™, 330™ Depend®	9460™, E-30CL™, 330™ Depend®	9460™, E-20HP™, E-00NS™	312™, 325™
WOOD, LEATHER, CARDBOARD	E-50GW™, 9460™, E-20HP™	9460™, E-20HP™	Cyanoacrylates or Hot Melt	Cyanoacrylates	9460™ E-20HP™	9460™, E-20HP™, E-00NS™	9460™, E-20HP™, E-00NS™, E-50GW™	Hot Melt
MAGNET	334™	E-214HP™, A-671™, A-6750™	331™	331™	331™	312™, 325™	Hot Melt	E-220IC™, 392™, 3060™

Please Note: These recommendations should only be used as a starting point. Testing is always recommended. Important! Read substrate specific recommendations first.

Your Source for **BONDING**
PLASTIC /
COMPOSITE BONDING
STRUCTURAL ADHESIVES

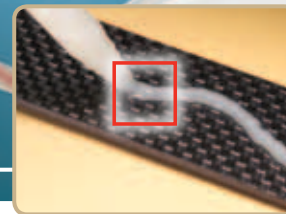
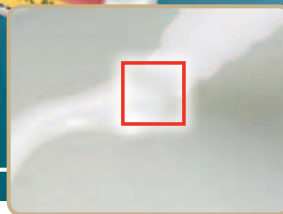

[Loctite® Plastic / Composite Bonding Structural Adhesives Properties Chart]

LOCTITE® PRODUCT	ITEM NUMBER	PACKAGE TYPE/SIZE	FEATURES	CHEMISTRY	COLOR	VISCOSITY (cP)	MIX RATIO	WORK LIFE (minutes)	FIXTURE TIME (minutes)	CURE TIME (hours)	SHEAR STRENGTH ¹ (psi)	IMPACT STRENGTH ¹ (joules)	PEEL STRENGTH ¹ (psi)
H4100™ SPEEDBONDER™	83032	490 ml dual cartridge	Ultra-Fast Fixture	Two-Part Acrylic	Pale Yellow	100,000	10:1	2	5	24	3,140	8	13
H4200™ SPEEDBONDER™	83038	490 ml dual cartridge	Fast Fixture	Two-Part Acrylic	Pale Yellow	90,000	10:1	9 ⁵	15	24	4,020	>42	55
H4000™ SPEEDBONDER™	83025	490 ml dual cartridge	Non-Sag	Two-Part Acrylic	Pale Yellow	130,000	10:1	30 ⁵	14	24	3,500	20	45
H6051™ SPEEDBONDER™	83062 83065 83063	490 dual cartridge 38 lb. pail, adhesive 60 lb. pail, activator	UV Resistant	Two-Part Acrylic	White	100,000	10:1	30 ⁵	50	24	2,400	N/A	35
H4800™ SPEEDBONDER™	996515 83045 83047* 83046*	50 ml dual cartridge 490 ml dual cartridge 40 lb. pail, adhesive 36 lb. pail, activator	Impact Resistant	Two-Part Acrylic	Light Yellow	50,000	10:1	30 ⁵	35	24	3,930	>42	50
E-120HP™ HYSOL®	29353 29354 29355 29356* 29357*	50 ml dual cartridge 200 ml dual cartridge 400 ml dual cartridge 5 gallon pail, resin 5 gallon pail, hardener	High Temperature/ Chemically Resistant	Two-Part Epoxy	Amber	30,000	2:1	120	>180	24	4,300	N/A	20-50
3982™ HYSOL®	36767	30 ml syringe	Fluorescent Heat Cure	One-Part Epoxy	Off-White	8,000	N/A	N/A	N/A	0.5 @ 257°F (125°C)	5,830 ⁴	1.5	N/A
E-119HP™ HYSOL®	1078992 1080008*	30 ml syringe 300 ml cartridge	Heat Cure Carbon-Fiber Bonder	One-Part Epoxy	Beige	Thixotropic	N/A	N/A	N/A	0.5 @ 252°F (122°C)	4,930	N/A	N/A
E-910™	1219191 1215342	25 g syringe 5 gallon pail	Low Cure Temperature	One-Part Epoxy	Green	40,000	N/A	N/A	N/A	1 @ 176°F (80°C)	2,000 ²	N/A	N/A

ITEMS IN RED = Source's PICK or NEW

* Made-to-order item.
¹ Steel.
² Aluminum.

³ Block shear on high density polyethylene.
⁴ Block shear – grit-blasted steel.
⁵ Work life = time for viscosity to double; Working time = maximum time before assembly (steel).

[Loctite® Plastic / Composite Bonding Structural Adhesives Properties Chart]

LOCTITE® PRODUCT	ITEM NUMBER	PACKAGE TYPE/SIZE	FEATURES	CHEMISTRY	COLOR	VISCOSITY (cP)	MIX RATIO	WORK LIFE (minutes)	FIXTURE TIME (minutes)	CURE TIME (hours)	SHEAR STRENGTH ¹ (psi)	IMPACT STRENGTH ¹ (joules)	PEEL STRENGTH ¹ (psi)	
GENERAL BONDING	H3000™ SPEEDBONDER™	83001 83000	50 ml dual cartridge 400 ml dual cartridge	High Strength	Two-Part Acrylic	Cream	45,000	1:1	15 ⁵	15	24	3,830	25	45
	H3300™ SPEEDBONDER™	83020 83019 83024* 83022*	50 ml dual cartridge 400 ml dual cartridge 40 lb. pail, adhesive 40 lb. pail, activator	Fast Fixture	Two-Part Acrylic	Yellow	110,000	1:1	7 ⁵	6	24	3,350	20	40
	E-04SS™	902242 901428* 901426*	400 ml dual cartridge 46 lb. pail, hardener 50 lb. pail, resin	Fast Fixture, Seam Sealing	Two-Part Epoxy	Stainless Steel	Light Paste	1:1	3	5-6	24	1,100	2.4	Not Tested
	U-09FL™ HYSOL®	29460 29461* 29462* 29370* 29371*	50 ml dual cartridge 200 ml dual cartridge 400 ml dual cartridge 5 gallon pail, resin 5 gallon pail, hardener	Flexible	Two-Part Urethane	Clear	5,000	1:1	10	120	24	1,460	5-30	Not Tested
	H3101™ SPEEDBONDER™	83007 83006	50 ml dual cartridge 400 ml dual cartridge	Medium Work Life	Two-Part Acrylic	Cream	75,000	1:1	9 ⁵	25	24	2,510	20	35
	H5004™ SPEEDBONDER™ 	1384596	50 ml dual cartridge	Low Odor	Two-Part Acrylic	Clear	18,000	1:1	1.5 ⁵	3	8	2,000	N/A	N/A
POLYOLEFIN BONDING	3032™	1051591 40760*	50 ml dual cartridge 490 ml dual cartridge	Fast Fixture	Two-Part Acrylic	Off-White	Thixotropic	10:1	3	25**	72	≥870** (HDPE)	6.7**	5.1 ²
	3034™	1051330 960973	50 ml cartridge 490 ml dual cartridge	Toughened	Two-Part Acrylic	Translucent	Thixotropic	10:1	14	75** (HDPE)	72	≥1,160	>13.6**	30 ²

ITEMS IN RED = Source's PICK or NEW



- * Made-to-order item.
- ¹ Steel.
- ² Aluminum.

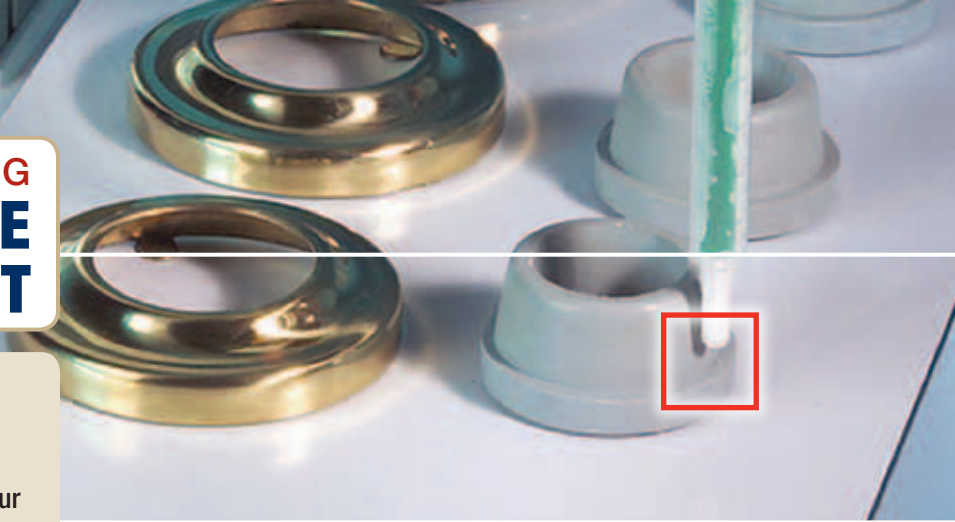

- ³ Block shear on high density polyethylene.
- ⁴ Block shear – Grit-blasted steel.
- ⁵ Work life = time for viscosity to double; working time = maximum time before assembly (steel).
- ** HDPE.

Your Source for **BONDING PLASTIC / COMPOSITE BONDING EQUIPMENT**

YOUR EQUIPMENT Source
 For more details, see the **Loctite® Equipment Sourcebook, LT-3669**, or visit us on the web for additional information, diagrams, products and our full line of equipment at www.equipment.loctite.com.



LOCTITE® PRODUCT		ITEM NUMBER	PRESSURE REGULATION	USED TO DISPENSE	PACKAGE TYPE & SIZES	VISCOSITY RANGE	LOW LEVEL SENSING	CONSUMABLES – DISPENSE ACCESSORIES	
DISPENSE SYSTEMS	PNEUMATIC CARTRIDGE DISPENSING								
		300 ML PNEUMATIC CARTRIDGE DISPENSING RETAINER	98319A	0 to 60 psi	Gel Cyanoacrylates, Anaerobic Gasketing, Light Cure/Acrylics, Silicones	300 ml cartridges	Low to Medium	Pneumatic	Cartridge Accessories – Page 183
		PNEUMATIC HANDHELD 300 ML DISPENSER	1294304	0 to 100 psi	Gel Cyanoacrylates, Anaerobic Gasketing, Light Cure/Acrylics, Silicones	300 ml cartridges 250 ml tubes	Medium to High	No	
	LOCTITE® HIGH PRESSURE 300ML BENCHTOP CARTRIDGE DISPENSER	1046901	0 to 725 psi	Silicone, Polyurethane, MS Polymer Adhesives	300 ml cartridges	10,000 to 1,000,000	Yes		

LOCTITE® PRODUCT		ITEM NUMBER	USED TO DISPENSE	PACKAGE TYPE AND SIZES	MIX RATIOS	VISCOSITY RANGE	TYPE	CONSUMABLES – DISPENSE ACCESSORIES	
HANDHELD APPLICATORS	SYRINGE DISPENSING								
		30 ML MANUAL SYRINGE APPLICATOR	98026	Any fluid in 30 ml syringe (25 ml of adhesive)	30 ml syringe	N/A	Low to High	Manual	Dispense Tips and Accessories – Pages 182-186 Syringe Accessories – Page 184
		30 ML SYRINGE MANUAL PLUNGERS	98193	Any fluid in 30 ml syringe	30 ml syringe (3 pack)	N/A	Low to High	Manual	N/A

ITEMS IN RED = Source's **PICK** or **NEW**

LOCTITE® BRANDED EQUIPMENT – Loctite® is a full service supplier of equipment and offers a wide variety of equipment services to its customers. **For more Loctite® branded equipment, go to page 171.**
 Can't find what you're looking for? Visit www.equipment.loctite.com or call 1-800-LOCTITE (562-8483).

STRAIGHT FROM The Source

MIX NOZZLES

Plastic, disposable nozzles that attach directly to Loctite® Speedbonder™ dual cartridges. They are designed to mix adhesive automatically as it travels through the static-mix nozzle.

Item #	Description
98473	(10) – 50 ml Square Mix Nozzle, Luer/Stepped Combo Tip, 4.5 in. Overall Length, 5.3 mm ² , 24 elements, 1:1, 2:1, 4:1 mix ratios
98454	(10) – 50 ml Mix Nozzle, Luer Tip, 6.0 in. Overall Length, 6.3 mm diameter, 21 elements, 1:1, 2:1, 4:1 mix ratios
98474	(10) – 200/400 ml Square Mix Nozzle, Stepped Tip, 5.1 in. Overall Length, 7.5 mm ² , 24 elements, 1:1, 2:1 mix ratios
98459	(10) – 200/400 ml Mix Nozzle, Stepped Tip, 10.9 in. Overall Length, 10 mm diameter, 24 elements, 1:1, 2:1 mix ratios
98461	(10) – 200/400 ml Mix Nozzle, Stepped Tip, Keyed, 10.8 in. Overall Length, 10 mm diameter, 24 elements, 4:1, 10:1 mix ratios

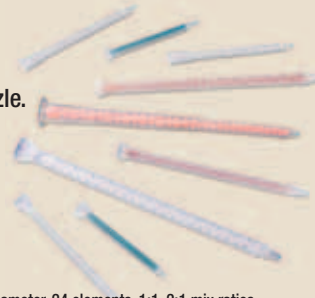

ADDITIONAL RESOURCES

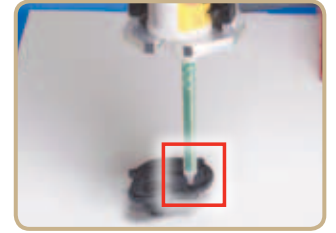

See pages 185 and 186 for more Loctite® Mix Nozzles or visit www.equipment.loctite.com.

LOCTITE® PRODUCT		ITEM NUMBER	USED TO DISPENSE	PACKAGE TYPE & SIZES	MIX RATIOS	VISCOSITY RANGE	TYPE	CONSUMABLES – DISPENSE ACCESSORIES		
HANDHELD APPLICATORS	TWO-PART DISPENSING									
		50 ML DUAL CARTRIDGE MANUAL APPLICATORS	98472	Two-Component Epoxies, Urethanes, Methacrylates	50 ml dual cartridge	1:1, 2:1, 4:1	Low to High	Manual	Static Mix Nozzles and Accessories – Pages 185-186	
			1034026		S-50 dual cartridge	10:1				
		50 ML DUAL CARTRIDGE PNEUMATIC APPLICATOR	97042	Two-Component Epoxies, Urethanes, Methacrylates	50 ml dual cartridge	1:1, 2:1, 10:1	Low to High	Pneumatic		
			CAULKING GUN CONVERSION KITS FOR 50 ML CARTRIDGES	98466	Two-Component Epoxies, Urethanes, Methacrylates	50 ml dual cartridge	1:1, 2:1	Low to High		Manual
			98415		10:1					
		200 ML / 400 ML DUAL CARTRIDGE MANUAL APPLICATORS	983436	Two-Component Epoxies, Urethanes, Methacrylates	200 ml dual cartridge	1:1, 2:1	High to Paste	Manual		
					983438	400 ml dual cartridge				1:1, 2:1
					985246	490 ml dual cartridge				10:1
			200 ML / 400 ML DUAL CARTRIDGE PNEUMATIC APPLICATORS	983437	Two-Component Epoxies, Urethanes, Methacrylates	200 ml dual cartridge	1:1, 2:1	High to Paste		Pneumatic
				983439		400 ml dual cartridge	1:1, 2:1			
				985249		490 ml dual cartridge	10:1			
	UNIVERSAL FIXMASTER® DISPENSER	1372751	Two-Component Epoxies, Urethanes, Methacrylates	200 ml and 400 ml dual cartridges	1:1, 2:1, 4:1, 10:1	High to Paste	Manual			

Your Source for COATINGS



[Table of Contents]

COATINGS	51
PROTECTIVE COATINGS	55
WEAR-RESISTANT COATINGS	57

[Protective Coatings]

Protective coatings serve many functions, including:

- Protection
- Insulating
- Sealing
- Corrosion protection

They can also be used to add gripping power or to color-code equipment. Many of these products also offer protection from harsh chemicals like acids, salts and alkalis, which are damaging to most industrial equipment.

WHAT IS THE DIFFERENCE BETWEEN A TREATMENT & A COATING?

A treatment, such as Loctite® Extend® Rust Treatment, is used to treat existing rust in an effort to correct a corrosion problem.

A coating is a product used for preventive maintenance and should be used on a clean part or a treated part. If corrosion exists on a surface, a coating will not correct the problem, and the substrate will continue to corrode underneath the protective coating. Using surface treatments and protective coatings together is the most effective solution for surface protection.

[Wear-Resistant Coatings]

ASSET PROTECTION

Wear and corrosion are common causes for failure in industrial equipment. Often this equipment is very expensive, and repairing and protecting these assets offers a significant cost savings. Loctite® Nordbak® wear-resistant coatings offer superior wear protection for new and worn equipment in a variety of applications. Extending service life and increasing efficiency through reduced friction are just two examples of the benefits of using protective coatings to safeguard your assets.

WHAT IS THE PROPER SURFACE PREPARATION FOR WEAR-RESISTANT COATINGS?

A properly prepared surface is one that has been cleaned, dried and abraded. Substrates should be free from contamination, including oils, grease, dust, etc. It is also important that a surface is dry before working with a wear-resistant coating, because moisture on the surface can interfere with the curing process. The final step is to abrade the surface, which provides an increased surface area for bonding. When working with metals, the surface should be abraded to a near-white metal finish, which also helps to ensure that all surface corrosion is removed.

Loctite® Adhesives and Sealants Product Specialists are available to assist you. For application assistance, call **1-800-LOCTITE (562-8483)**; *within Canada, call 1-800-263-5043*; or, contact us through the web at www.henkelna.com/loctite.

STRAIGHT FROM *The Source*

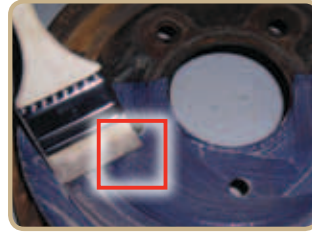
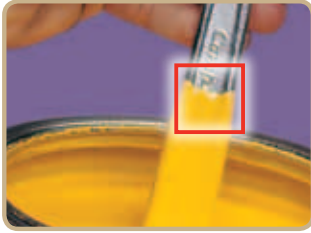

Your Source PROTECTIVE COATINGS GUIDE

WHAT TYPE OF PROTECTION DO YOU NEED?

Corrosion

Rust Treatment

Loctite® Extend Coating

Item #	Clear Liquid	30539	10.25 oz. net. wt. aerosol
	Converts from a White Liquid to Matte Black	75430 75448 75465	1 quart bottle 1 gallon bottle 5 gallon pail

Preventive Protection

NON-DRYING

Loctite® Maxi-Coat™

Item #	51211	12 oz. net wt. aerosol
Item #	51213	1 gallon can

CATHODIC PROTECTION

Loctite® Cold Galvanizing Compound

Item #	82039	15 oz. net. wt. aerosol
--------	-------	-------------------------

UNDERCOATING

Loctite® Heavy-Duty Rubberized Undercoating

Item #	30538	16 oz. net. wt. aerosol
--------	-------	-------------------------

Extreme Chemical Attack

Loctite® Nordbak® Chemical-Resistant Coating

Item #	96092	12 lb. kit
--------	-------	------------

Specialty Coatings

COLOR CODING

Loctite® Color Guard® Coating

Item #	Black	34979	14.5 fl. oz. can
Item #	Black	34980	1 gallon can
Item #	Black	34981*	54 gallon drum
Item #	Blue	34982	14.5 fl. oz. can
Item #	Blue	34983	1 gallon can
Item #	Red	34985	14.5 fl. oz. can
Item #	Red	34986	1 gallon can
Item #	Yellow	34988	14.5 fl. oz. can
Item #	Yellow	34989	1 gallon can

BELT DRESSING

Loctite® Belt Dressing and Conditioner

Item #	30527	12 oz. net. wt. aerosol
--------	-------	-------------------------

Your Source for
COATINGS



**ARE YOU EXPERIENCING MECHANICAL WEAR / ABRASION
OR CORROSION / EROSION?**

Wear / Abrasion

SLIDING ABRASION OR IMPACT RESISTANCE?

Sliding Abrasion

COARSE PARTICLE, FINE PARTICLE OR TURBULENCE?

Coarse / Large Particle Abrasion		Fine Particle Abrasion	
LARGE PARTICLE WEAR TO 250°F (121°C)	FAST CURING, LARGE PARTICLE WEAR TO 225°F (107°C)	FINE PARTICLE WEAR TO 250°F (121°C)	FAST CURING, FINE PARTICLE WEAR TO 225°F (107°C)
Loctite® Nordbak® Wearing Compound Item # 1324008 5 lb. kit 1323940 25 lb. kit	Loctite® Nordbak® Fast Cure Wearing Compound Item # 96373 6 lb. kit	Loctite® Nordbak® Pneu-Wear Item # 98383 3 lb. kit 98382 25 lb. kit	Loctite® Nordbak® Fast Cure Pneu-Wear Item # 96363 6 lb. kit 1117828* 25 lb. kit
LARGE PARTICLE WEAR TO 450°F (232°C)	COMBINED RESISTANCE FOR LARGE AND FINE PARTICLE TO 250°F (121°C)	FINE PARTICLE WEAR TO 450°F (232°C)	NON-RUST PUTTY WITH FINE PARTICLE WEAR RESISTANCE
Loctite® Nordbak® High Temperature Wearing Compound Item # 99112 25 lb. kit	Loctite® Nordbak® Combo Bead Wearing Compound Item # 1324571 6 lb. kit	Loctite® Nordbak® High Temperature Pneu-Wear Item # 98372 25 lb. kit	Loctite® Fixmaster® Wear-Resistant Putty Item # 98742 1 lb. kit 98743 3 lb. kit
LARGE PARTICLE WEAR TO 550°F (288°C)	LOW ODOR, LARGE PARTICLE WEAR TO 250°F (121°C)	FINE PARTICLE WEAR TO 550°F (288°C)	
Loctite® Nordbak® Ultra-High Temperature Wearing Compound Item # 96392 25 lb. kit	Loctite® Nordbak® Low Odor Wearing Compound Item # 41343 25 lb. kit	Loctite® Nordbak® Ultra-High Temperature Pneu-Wear Item # 96332 25 lb. kit	

* Made-to-order item.

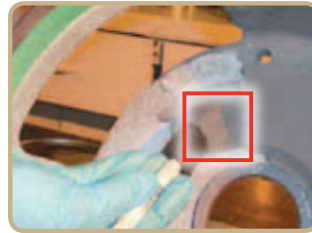

Your Source **WEAR-RESISTANT COATINGS GUIDE**

Liquid / Slurry Turbulence

LOW FRICTION, TURBULENCE RESISTANCE TO 200°F (93°C)

**Loctite® Nordbak®
Brushable Ceramic**

Item #	Grey	98733	2 lb. kit
	Grey	98732	6 lb. kit
	White	96443	2 lb. kit
	Grey	997367*	12 lb. kit

LOW FRICTION, TURBULENCE RESISTANCE TO 550°F (288°C)

**Loctite® Nordbak®
High Temperature
Brushable Ceramic**

Item #	96433	2 lb. kit
	997369*	12 lb. kit

THIN MIL, LOW FRICTION, TURBULENCE RESISTANCE TO 200°F (93°C)

**Loctite® Nordbak®
Brushable Ceramic –
Thin Mil**

Item #	Blue	40591	2 lb. kit
--------	------	-------	-----------

Impact

**Loctite® Nordbak®
High Impact
Wearing Compound**

Item #	1327836	25 lb. kit
--------	---------	------------

**Loctite® Fixmaster®
Flex 80™ Putty**

Item #	97423	1 lb. kit
	97422	6 lb. kit

Specialty

**Loctite® Nordbak®
Castable Wearing
Compound**

Item #	98992	25 lb. kit
--------	-------	------------

**Loctite® Ceramic
Tile Adhesive**

Item #	1324544	20 lb. kit
--------	---------	------------

**Extreme
Chemical Resistance**

**Loctite® Nordbak®
Chemical-Resistant
Coating**

Item #	96092	12 lb. kit
--------	-------	------------

WEAR-RESISTANT COATINGS TECHNICAL CATALOG AND BROCHURE

Let Henkel help you select the proper coating for your application.

Refer to Loctite® Wear-Resistant Coatings Technical Catalog and Brochure by visiting www.henkelna.com/loctite.

Click on **Literature** and then select **Coatings** to view the guides or request copies.



ADDITIONAL RESOURCES

* Made-to-order item.

Your Source for COATINGS

PROTECTIVE COATINGS

- Protects, seals, insulates, prevents corrosion, color codes and adds gripping power
- Products available that provide excellent resistance to acids, alkalis, salt and moisture, which can damage equipment

[Liquid Rubber Coatings]

Loctite® Color Guard® Coating

INHIBITS RUST AND CORROSION, SEALS, INSULATES AND IDENTIFIES

A solvent-based, modified thermoplastic liquid coating that dries to a durable, flexible, rubber-like protective coating on parts and equipment. Dip, spray or brush to apply. Great for tools, metals, electrical connections, masonry, wood, conveyors, glass, rope and fabric.

Item #	Black	34979	14.5 fl. oz. can
	Black	34980	1 gallon can
	Black	34981*	54 gallon drum
	Blue	34982	14.5 fl. oz. can
	Blue	34983	1 gallon can
	Red	34985	14.5 fl. oz. can
	Red	34986	1 gallon can
	Yellow	34988	14.5 fl. oz. can
	Yellow	34989	1 gallon can

Loctite® Color Guard® Primer

Promotes adhesion on metals; highly recommended for use when coating metal hand tools. Allow the primer to dry for 10 to 15 minutes before coating with Loctite® Color Guard® Coatings. Use with pressure pot or airless spray systems.

Item #	34994	1 gallon can
--------	-------	--------------

Loctite® Color Guard® Thinner

Thinner is required for use when spraying any of the Loctite® Color Guard® Coatings. Helps reduce any clogging and is recommended for use with pressure pot or airless spray systems. See technical data sheets on www.henkelna.com/loctite for other helpful suggestions. This product can also be used to remove cured Loctite® Color Guard® Coating.

Item #	34995	1 gallon can
--------	-------	--------------

* Made-to-order item.

[Rust Treatment]

Loctite® Extend® Rust Treatment

Converts existing rust (rust required) into a stable base. Cured product acts as a primer ready for painting with oil- or solvent-based paint. Protects surface from corrosion. Use on metal pipes, valves, fittings, outside surfaces of storage tanks, fences, guardrails, wrought iron furniture, conveyors, and construction and agricultural equipment.

Item #	30539	10.25 oz. net wt. aerosol (Clear)
	75430	1 quart bottle
	75448	1 gallon bottle
	75465	5 gallon pail

[Specialty Coatings]

Loctite® Heavy-Duty Rubberized Undercoating

This heavy-duty undercoating seals, protects and insulates. Rubberized for maximum durability.

Item #	30538	16 oz. net wt. aerosol
--------	-------	------------------------

Loctite® Maxi-Coat™

Heavy-duty coating provides long-term protection for metal parts, equipment and machinery. Forms a protective, waxy film that seals out moisture, air, acid and other corrosive elements. Great for protecting parts in storage. Removable with Loctite® Electrical Contact Cleaner.

Item #	51211	12 oz. net wt. aerosol
	51213	1 gallon can

Loctite® Cold Galvanizing Compound

Sprays on metal surfaces to prevent corrosion even when the surface is scratched. Ideal touch-up for welded seams. Highly resistant to salt corrosion and water. Not resistant to acid or alkaline solutions. Contains no ozone-depleting compounds.

Item #	82039	15 oz. net wt. aerosol
--------	-------	------------------------

Loctite® Belt Dressing & Conditioner

Recommended to prevent slipping and increase friction for all types of belts. Extends belt life. Penetrates the cord fibers of "V" belts to restore pliability and flexibility. Eliminates squeaking and glazing.

Item #	30527	12 oz. net wt. aerosol
--------	-------	------------------------

Loctite® Nordbak® Chemical Resistant Coating

Smooth, glossy, low friction finish protects against turbulence, abrasion and cavitation. This advanced epoxy protects equipment from extreme chemical attack and corrosion. Low viscosity epoxy can be applied by brush.

Item #	96092	12 lb. kit
--------	-------	------------

COATING HINTS

- When coating any surface, make sure the parts are clean and dry. Try doing a small test piece first to confirm that the coating meets your expectations. This will save you time and money if the desired results are not achieved.
- Loctite® Color Guard® Thinner can be used to remove cured Loctite® Color Guard® Coating.
- Loctite® Color Guard® Coating colors can be mixed to make different colors.

HELPFUL HINTS



[Applications]

- Tool Handle
- Temporary Storage
- Rust Prevention
- Corrosion Resistance

[Industries]

- Mining
- Wastewater
- Power Generation
- Food Processing

- Pulp and Paper
- Beverage
- Tool and Die
- General Manufacturing

[Loctite® Protective Coatings Properties Chart]

	LOCTITE® PRODUCT	ITEM NUMBER	PACKAGE TYPE/SIZE	COLOR	TEMPERATURE	DRY TIME	FULL CURE	COVERAGE	APPLICATION METHOD	AGENCY APPROVALS
LIQUID RUBBER COATINGS	COLOR GUARD® COATING	34979 34980 34981*	14.5 fl. oz. can 1 gallon can 54 gallon drum	Black	Up to 200°F (93°C)	4 hours (allow 30 minutes between coats)	24 hours at ambient temperature	180 sq. ft. per gallon at 2.5 mil thickness	Dip, brush or spray	CFIA
	COLOR GUARD® COATING	34982 34983	14.5 fl. oz. can 1 gallon can	Blue						
	COLOR GUARD® COATING	34985 34986	14.5 fl. oz. can 1 gallon can	Red						
	COLOR GUARD® COATING	34988 34989	14.5 fl. oz. can 1 gallon can	Yellow						
	COLOR GUARD® PRIMER (PROMOTES ADHESION ON METALS)	34994	1 gallon can	Grey	N/A	10 to 15 minutes	10 to 15 minutes before dipping or coating	150 to 200 sq. ft. per gallon at 0.5 to 1 mil thickness	Brush or spray	N/A
	COLOR GUARD® THINNER	34995	1 gallon can	Clear Solvent	N/A	Mixed in coating	N/A	Brushing: 1 part thinner to 2 parts coating	Brush or spray	N/A
RUST TREATMENT	EXTEND® RUST TREATMENT	30539	10.25 oz. net wt. aerosol	Clear Liquid	Up to 250°F (121°C)	Re-coat in 2 to 3 minutes	24 hours at ambient temperature	200 sq. ft. per gallon at 2.5 mil thickness	Aerosol spray	ABS, CFIA
		75430 75448 75465	1 quart bottle 1 gallon bottle 5 gallon pail	Converts from a White Liquid to Matte Black	Up to 250°F (121°C)	Re-coat in 20 minutes			Brush or commercial sprayer	
		HEAVY-DUTY RUBBERIZED UNDERCOATING	30538	16 oz. net wt. aerosol	Brown to Black	Up to 200°F (93°C)			20 minutes	
SPECIALTY COATINGS	MAXI-COAT™	51211 51213	12 oz. net wt. aerosol 1 gallon can	Brown	Up to 200°F (93°C)	3 to 6 hours	Waxy coat	Apply heavy coat with brush	Brush on	CFIA
	COLD GALVANIZING COMPOUND	82039	15 oz. net wt. aerosol	Low Gloss Grey	Up to 400°F (204°C) constant; 600°F (316°C) intermittent	15 minutes to touch	24 hours at ambient temperature	Apply heavy coat at 12 to 15 inches away	Aerosol spray	CFIA
	BELT DRESSING & CONDITIONER	30527	12 oz. net wt. aerosol	White	Up to 200°F (93°C)	Penetrates belt	Increases friction right away	Spray light coating	Aerosol spray	CFIA
	NORDBAK® CHEMICAL RESISTANT COATING	96092	12 lb. kit	Grey	Up to 150°F (65°C) wet; >200°F (93°C) dry	16 hours	16 hours	74 sq. ft. at 20 mil thickness	Roll or brush on	CFIA

Your Source for **COATINGS**
WEAR-RESISTANT
COATINGS

- Utilizes the superior wear properties of ceramic and the convenience of two-part epoxies to protect equipment like pumps chutes, and augers in harsh industrial environments
- Stands up to almost any corrosion, abrasion and wear problem you can encounter
- Ideal for all of those large-scale repairs that have to last
- Available in trowelable and brushable formulations with special fillers for tough conditions



[Coarse / Large
Particle Abrasion]

**Loctite® Nordbak®
Wearing Compound**

Large ceramic beads and fine silicon carbide in a high performance epoxy system protect against sliding abrasion to 250°F (121°C). Trowelable.

Item # 1324008 5 lb. kit
1323940 25 lb. kit

**Loctite® Nordbak® High
Temperature Wearing Compound**

Resists sliding abrasion and temperatures to 450°F (232°C). Must be post-cured for maximum temperature resistance and performance. Trowelable.

Item # 99112 25 lb. kit

**Loctite® Nordbak® Ultra-High
Temperature Wearing Compound**

Resists sliding abrasion and temperatures to 550°F (288°C). Must be post-cured for maximum temperature resistance and performance. Trowelable.

Item # 96392 25 lb. kit

**Loctite® Nordbak®
Fast Cure Wearing Compound**

A faster curing version of Loctite® Nordbak® Wearing Compound, this epoxy renews worn surfaces fast, reducing downtime to put equipment back in service in as few as 3 hours. Trowelable.

Item # 96373 6 lb. kit

**Loctite® Nordbak® Combo
Bead Wearing Compound**

This epoxy system combines the abrasion-resistant qualities of both large and small ceramic beads and silicon carbide. Protects against hard sliding abrasion and extends the life of material handling equipment. Trowelable.

Item # 1324571 6 lb. kit

[Coarse / Large
Particle Abrasion]

**Loctite® Nordbak®
Low Odor Wearing Compound**

Loctite® Nordbak® Low Odor Wearing Compound offers the same protection against coarse/large particle abrasion as Loctite® Nordbak® Wearing Compound, while offering a low odor formulation. This coating is particularly suited for applications in areas where ventilation may be limited.

Item # 41343 25 lb. kit

[Fine Particle Abrasion]

Loctite® Nordbak® Pneu-Wear

Filled with small ceramic beads and silicon carbide for maximum protection against fine particle abrasion to 250°F (121°C). Trowelable.

Item # 98383 3 lb. kit
98382 25 lb. kit

**Loctite® Nordbak®
High Temperature Pneu-Wear**

Protects against fine particle abrasion and temperatures to 450°F (232°C). Must be post-cured for maximum temperature resistance and performance. Trowelable.

Item # 98372 25 lb. kit

**Loctite® Nordbak®
Ultra-High Temperature Pneu-Wear**

Protects against fine particle abrasion and temperatures to 550°F (288°C). Must be post-cured for maximum temperature resistance and performance. Trowelable.

Item # 96332 25 lb. kit

**Loctite® Nordbak® Fast
Cure Pneu-Wear**

Fast cure version of standard Loctite® Nordbak® Pneu-Wear protects against fine particle abrasion to 225°F (107°C) and cures in just 3 hours. Trowelable.

Item # 96363 6 lb. kit
1117828* 25 lb. kit

* Made-to-order item.

Sources REVEALED

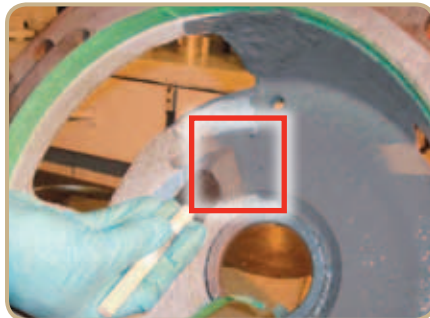

[Applications]

- Pump
- Gearbox
- Concrete Repair
- Conveyor Systems
- Shaft Repair

[Industries]

- Mining
- Wastewater
- Power Generation

- Food Processing
- Pulp and Paper
- Beverage

APPLICATIONS
& INDUSTRIES

Loctite® Fixmaster® Wear-Resistant Putty

Ceramic fibers give this trowelable putty excellent wear and abrasion resistance properties. Cures to a smooth, low friction surface. For surfaces exposed to wear, erosion and cavitation.

Item # 98742 1 lb. kit
98743 3 lb. kit

[Impact Wear Resistance]

Loctite® Nordbak® High Impact Wearing Compound

Rubber-modified epoxy protects against sliding abrasion and impact to 250°F (121°C). Trowelable.

Item # 1327836 25 lb. kit

Loctite® Nordbak® Ceramic Tile Adhesive

High strength. For securing ceramic wear tiles to vertical, horizontal and overhead surfaces. Excellent shock and impact resistance. Trowelable. Resists temperatures to 200°F (93°C).

Item # 1324544 20 lb. kit

[Liquid / Slurry Turbulence]

Source's PICK

Loctite® Nordbak® Brushable Ceramic

Brushes on to form a smooth, corrosion-resistant coating. Protects against turbulence, abrasion and cavitation. Can also be used as a topcoat over Loctite® Nordbak® Wearing Compound for surface rebuilding and lasting protection. Resists temperatures up to 200°F (93°C).

Item #	Grey	98733	2 lb. kit
	Grey	98732	6 lb. kit
	White	96443	2 lb. kit
	Grey	997367*	12 lb. kit

Loctite® Nordbak® High Temperature Brushable Ceramic

Provides protection against turbulence, abrasion and cavitation up to 550°F (288°C). Must be post-cured for maximum temperature resistance and performance.

Item #	96433	2 lb. kit
	997369*	12 lb. kit

Loctite® Fixmaster® Flex 80™ Putty

A trowelable, two-part urethane for rebuilding and repairing rubber parts and linings, providing impact, abrasion and corrosion-resistant protection.

Item #	97423	1 lb. kit
	97422	6 lb. kit

[Specialty Wear Resistance]

Loctite® Nordbak® Castable Wearing Compound

For casting wear-resistant parts. Pourable ceramic compound can be cast into any shape. Resists temperatures to 225°F (107°C).

Item # 98992 25 lb. kit

[Specialty Coatings]

Loctite® Nordbak® Chemical Resistant Coating

Smooth, glossy, low friction finish protects against turbulence, abrasion and cavitation. This advanced epoxy protects equipment from extreme chemical attack and corrosion. Low viscosity epoxy can be applied by brush.

Item # 96092 12 lb. kit



COATING HINTS

- You may smooth out any composite repair product using isopropyl alcohol (IPA) or acetone and a gloved hand.
- When applying two coats of Loctite® Nordbak® Brushable Ceramic, a different color can be used for each: grey and white. When the first coat begins to wear, the second color coat will show through, providing an accurate visual indicator of wear.

HELPFUL HINTS

* Made-to-order item.

Your Source for **COATINGS**
WEAR-RESISTANT
COATINGS



[**Loctite® Wear-Resistant Coatings Properties & Applications Chart**]

	LOCTITE® PRODUCT	ITEM NUMBER	PACKAGE TYPE/SIZE	COVERAGE (FT ² @ 1/4 IN. THICKNESS)	COLOR	MAXIMUM OPERATING TEMPERATURE (°F)	COMPRESSIVE STRENGTH (pst)	HARDNESS (SHORE D)	WORKING TIME (MINUTES) 77°F	FUNCTIONAL CURE (HOURS) 77°F	MIX RATIO BY VOLUME (R : H)	
COARSE/LARGE PARTICLE ABRASION	NORDBAK® WEARING COMPOUND	1324008 1323940	5 lb. kit 25 lb. kit	1.75 8.7	Grey	250	16,000	90	30	7	2:1	
	NORDBAK® HIGH TEMPERATURE WEARING COMPOUND	99112	25 lb. kit	8.7	Grey	450	15,000	90	30	N/A	4:1	
	NORDBAK® ULTRA-HIGH TEMPERATURE WEARING COMPOUND	96392	25 lb. kit	8.7	Red	550	N/A	90	30	N/A	2.5:1	
	NORDBAK® FAST CURE WEARING COMPOUND	96373	6 lb. kit	2.3	Blue	225	10,000	90	10	3	2:1	
	NORDBAK® COMBO BEAD WEARING COMPOUND	1324571	6 lb. kit	2.3	Grey	250	13,000	90	25	8	2:1	
	NORDBAK® LOW ODOR WEARING COMPOUND	41343	25 lb. kit	8.75	Grey	250	16,000	90	30	7	2:1	
FINE PARTICLE ABRASION	NORDBAK® PNEU-WEAR	98383 98382	3 lb. kit 25 lb. kit	1.1 9	Grey	250	15,000	85	30	6	4:1	
	NORDBAK® HIGH TEMPERATURE PNEU-WEAR	98372	25 lb. kit	8.7	Grey	450	15,000	90	30	N/A	4:1	
	NORDBAK® ULTRA-HIGH TEMPERATURE PNEU-WEAR	96332	25 lb. kit	8.8	Red	550	N/A	90	30	N/A	2:1	
	NORDBAK® FAST CURE PNEU-WEAR	96363 1117828***	6 lb. kit 25 lb. ki	2.3 9.6	Blue	225	12,000	90	10	3	2:1	
	NORDBAK® WEAR-RESISTANT PUTTY	98742 98743	1 lb. kit 3 lb. kit	0.37 1.11	Grey	225	11,600	89	30	N/A	2:1	
LIQUID/SLURRY TURBULENCE	NORDBAK® BRUSHABLE CERAMIC - GREY	98733 98732 997367***	2 lb. kit 6 lb. kit 12 lb. kit	12* 36* 72*	Grey	200	10,180	85	30	6	2.75:1	
	NORDBAK® BRUSHABLE CERAMIC - WHITE	96443	2 lb. kit	12*	White	200	10,866	85	15	5	2.8:1	
	NORDBAK® HIGH TEMPERATURE BRUSHABLE CERAMIC	96433 997369***	2 lb. kit 12 lb. kit	12*	Red	550	16,000	90	120	N/A	2.6:1	
IMPACT WEAR RESISTANCE	NORDBAK® HIGH IMPACT WEARING COMPOUND	1327836	25 lb. kit	8.75	Grey	250	12,000	85	30	6	2:1	
	FIXMASTER® FLEX 80™ PUTTY	97423 97422	1 lb. kit 6 lb. kit	94** 560**	Black	180	N/A	87π	10	8	2.5:1	
SPECIALTY WEAR RESISTANCE	NORDBAK® CASTABLE WEARING COMPOUND	98992	25 lb. kit	277 in. ³	Grey	225	18,500	90	30	6	2:1	
	NORDBAK® CERAMIC TILE ADHESIVE	1324544	20 lb. kit	12	Beige	200	14,000	88	60	12	1:1	
SPECIALTY COATINGS	NORDBAK® CHEMICAL RESISTANT COATING	96092	12 lb. kit	74 sq. ft. at 20 ml thickness	Grey	150 wet/ >200 dry	10,000	83	N/A	N/A	2.3:1	

ITEMS IN RED = Source's PICK or NEW

* 20 mil thickness ** in.² at 1/4 in. thickness ^π Shore A *** Made-to-order item.

△ Good Choice ▲ Preferred Choice ■ Requires heat cure. See Technical Data Sheet.

PLEASE NOTE: Properties are based on mixing 1 lb. mass at 77°F, ultimate cure.

	MIX RATIO BY WEIGHT (R:H)	AGENCY APPROVALS	FINE PARTICLE ABRASION	MULTIPLE PARTICLE ABRASION	IMPACT RESISTANCE	CHEMICAL CORROSION PROTECTION	HIGH TEMPERATURE RESISTANCE	FAST CURE	CORROSION PROTECTION	TILE INSTALLATION	PUMP REPAIR	ELBOWS	FAN HOUSINGS	CYCLONES	CHUTES
	2:1	NEHC, NAVSEA									△	△	▲	△	▲
	3.9:1	N/A					▲				△	△	▲	△	▲
	2.85:1	N/A					▲				△	△	▲	△	▲
	2:1	N/A						▲			△	△	▲	△	▲
	2:1	N/A	△	▲								△	△	△	△
	2:1	N/A	△	▲											
	4:1	ABS, CFIA, NEHC, NAVSEA, Lloyd's	▲	△							▲	▲	△	▲	△
	4:1	N/A	▲	△			▲				▲	▲	△	▲	△
	2.27:1	N/A	▲	△			▲				▲	▲	△	▲	△
	2:1	CFIA	▲	△				▲			▲	▲	△	▲	△
	2:1	N/A				△			△		▲	▲	△	▲	△
	4.8:1	ABS, CFIA, NSF® (pending)				△			▲		△				
	4.5:1	CFIA				△			▲		△				
	4.25:1	N/A				△	▲		▲		△				
	2:1	N/A			▲										
	2.6:1	ABS			▲										
	6.8:1	N/A	△	△		△						▲		▲	
	1:1.25	N/A			△					▲					
	3.4:1	CFIA													

Your Source for
FLOORING & CONCRETE REPAIR



[Table of Contents]

FLOORING & CONCRETE REPAIR	61
ANTI-SLIP COATINGS	65
FLOOR SEALANTS & TOPCOATS	67
FLOORING, CONCRETE REPAIR & GROUTING	69

[Anti-Slip Coatings]

CHOOSING AN ANTI-SLIP COATING

When choosing an anti-slip coating, there are several factors to consider – the most important of which is profile size. A more aggressive profile will provide better traction and a higher coefficient of friction. A lower profile will provide a better walking surface and will be easier to clean, in addition to the anti-slip properties.

It is also important to consider the substrate that is being coated and the type of exposure the coating will endure. Information and charts on the following pages will help guide you through your selection process.

WHEN DO I NEED TO USE A PRIMER?

It is always recommended that a primer be used before applying an anti-slip coating. Primers increase adhesion to the substrate and also seal porosity when applied on concrete. The decision on which primer to use is based on the product being used and the substrate. The following chart will assist you in choosing the right primer for your application.

Your Source **ANTI-SLIP PRIMER GUIDE**

WHAT IS THE SURFACE OF THE SUBSTRATE?

Concrete/Porous Surface	Metal
<p>Loctite® Big Foot® Water-Based Primer/Sealer</p> <p><small>Item #</small> 94142 1 gallon kit</p> <p><small>Note:</small> For All Loctite® Big Foot® Products except Loctite® Big Foot® Acrylic Pedestrian Grade</p>	<p>Loctite® Big Foot® Metal Primer</p> <p><small>Item #</small> 96132 1 gallon kit</p> <p><small>Note:</small> For All Loctite® Big Foot® Products including Loctite® Big Foot® Acrylic Pedestrian Grade</p>
<p>Loctite® Big Foot® Acrylic Primer</p> <p><small>Item #</small> 95581 1 gallon pail</p> <p><small>Note:</small> For Loctite® Big Foot® Acrylic Pedestrian Grade and Flexible Low Profile</p>	

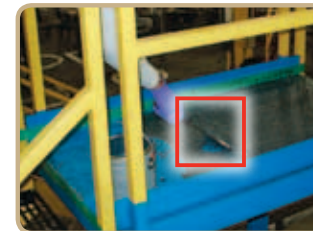

Your Source ANTI-SLIP COATINGS GUIDE

WHAT TYPE OF TRAFFIC DOES THE AREA CONTAIN?

Pedestrian		Vehicular	
LIGHT PEDESTRIAN TRAFFIC, ENHANCED CLEANABILITY	HEAVY PEDESTRIAN OR LIGHT ROLLING TRAFFIC	HEAVY ROLLING EQUIPMENT TRAFFIC	MOST AGGRESSIVE PROFILE AND ODOR-SENSITIVE AREAS
Loctite® Big Foot® Low Pedestrian Profile Pedestrian Grade Item # 40352 1 gallon kit	Loctite® Big Foot® Heavy Duty Pedestrian Grade Item # Black 96211 1 gallon can Grey 96261 1 gallon can Grey 96265 5 gallon pail Yellow 40302 1 gallon can Yellow 40303 5 gallon pail	Loctite® Big Foot® Vehicular Grade Item # Black 96221 1 gallon kit Grey 96251 1 gallon kit Grey 96255 5 gallon kit	Loctite® Big Foot® Zero V.O.C. Item # Grey 39915 1 gallon kit Black 96231 1 gallon kit
ASPHALT, OUTDOOR OR FLEXIBLE APPLICATIONS			
Loctite® Big Foot® Acrylic Pedestrian Grade Item # Grey 95591 1 gallon pail Black 36045 1 gallon pail			
BAREFOOT			
Loctite® Big Foot® Flexible Low Profile Exterior Grade Item # Grey 1354766 1 gallon kit Black 1352349 1 gallon kit			

Loctite® Adhesives and Sealants Product Specialists are available to assist you with new product designs, or to help you re-engineer an existing application for improved performance and cost savings. They can also set up testing of your parts at the Henkel Customer Engineering Center. For application assistance, call **1-800-LOCTITE (562-8483)**; within Canada, call **1-800-263-5043**; or, contact us through the web at www.henkelna.com/loctite.

STRAIGHT FROM *The Source*

Your Source for
FLOORING & CONCRETE REPAIR



[FLOOR SEALANTS & TOPCOATS]

Easy to mix and use, Loctite® Fixmaster® floor coating systems offer the solutions needed to keep facilities looking good and performing great. These two- or three-part, pre-measured epoxy and urethane systems are non-shrinking and will bond to concrete without the use of special bonding agents. Available in multiple colors, these coatings offer high chemical resistance, and provide a hard wearing and durable surface.

Loctite® Adhesives and Sealants Product Specialists are available to assist you with new product designs, or to help you re-engineer an existing application for improved performance and cost savings. They can also set up testing of your parts at the Henkel Customer Engineering Center. For application assistance, call **1-800-LOCTITE (562-8483)**; *within Canada, call 1-800-263-5043*; or, contact us through the web at www.henkelna.com/loctite.

STRAIGHT FROM *The Source*

Your Source **TOPCOATS GUIDE**

WHAT IS THE SURFACE OF THE SUBSTRATE?

Industrial Wear

**Loctite® Fixmaster®
Self-Leveling Flooring Epoxy**

Item #	40332	Deck Grey	Complete 1 gallon kit
	40334	Haze Grey	Complete 1 gallon kit
	40342	Hardener	1.5 gallon Hardener
	40333	Deck Grey	3.5 gallon Resin*
	40335	Haze Grey	3.5 gallon Resin*

* A Hardener must be added.

Your Source **PRIMERS / SEALERS GUIDE**

IS THE SURFACE MECHANICALLY PREPARED (ABRADED)?

No

**Loctite® Fixmaster®
Water-Based Epoxy Primer/Sealer**

Item #	40348	Complete	2 gallon kit
	40349	Must have Hardener	10 gallon Resin
	40351	Must have Resin	10 gallon Hardener

Yes

**Loctite® Fixmaster®
High Solids Floor Coating Primer**

Item #	40319	Clear	1 gallon kit
	40320	Clear Resin	3.5 gallon
	40321	Clear Hardener	1.5 gallon

* Needs Clear or Color Resin.
 ** A Hardener must be added.

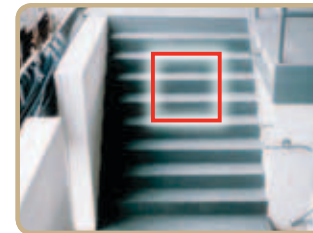

[FLOORING, CONCRETE REPAIR & GROUTING]

Industrial floors require maintenance approximately every six months. Damage from day-to-day traffic, heavy load and chemical erosion can lead to a floor that needs a lot of work. Loctite® flooring and grouting products can address all of your floor repair needs and help you maintain a safe, efficient workplace.

When choosing a floor or concrete repair product, the important things to consider are substrate condition, traffic and chemical exposure, and time available to complete the repair. Information and charts on the following pages will help you choose a product

that will provide superior protection against the harshest environments or get your floor back in service in under an hour!

HOW IMPORTANT IS SURFACE PREPARATION?

A floor repair is only as good as the concrete or substrate to which it is adhering. It is important to check thoroughly for damaged or loose concrete, because a failure of the substrate below the repair would eventually degrade the integrity of the repair itself. Surface preparation is the most important aspect of any concrete or floor repair.

Your Source FLOORING, CONCRETE REPAIR & GROUTING GUIDE

WHAT TYPE OF APPLICATION IS NEEDED?

Concrete Repair		Grouting	
<p>General Floor Repair</p> <p>FAST CURE</p> <p>Loctite® Fixmaster® Magna-Crete™</p> <p>Item # 95551 1 gallon kit 95555 5 gallon kit 1012500 1 lb., 12 oz. kit 831304 2,475 lb. tote 976786 55 gallon drum – Activator 40270 1 lb. tub – Winter Additive 40271 1 lb. tub – Summer Additive</p> <p>Loctite® Fixmaster® Magna-Grout</p> <p>Item # 1477097 1 gallon kit 1476710 5 gallon kit 1476709 2,475 lb. tote 40270 1 lb. tub – Winter Additive 40271 1 lb. tub – Summer Additive</p> <p>HIGH STRENGTH</p> <p>Loctite® Fixmaster® Floor Fill</p> <p>Item # 99361 10 lb. kit 99365 40 lb. kit</p> <p>SMALL CRACK REPAIR</p> <p>Loctite® Fixmaster® Crack Filler</p> <p>Item # 40346 1 gallon kit</p> <p>Loctite® Fixmaster® Crack Filler SL</p> <p>Item # 1291113 8.6 oz. cartridge</p>	<p>NON-SAG CRACK REPAIR</p> <p>Loctite® Fixmaster® Crack Filler NS</p> <p>Item # 1108886 8.6 oz. cartridge</p> <p>Extreme Chemical Resistance</p> <p>Loctite® Fixmaster® High Performance Quartz</p> <p>Item # 96495 42 lb. kit</p> <p>Small Concrete Repairs</p> <p>Loctite® Fixmaster® Concrete Repair Epoxy</p> <p>Item # 39366 4 oz. stick</p> <p>Expansion Joints</p> <p>Loctite® Fixmaster® Flexible Joint Sealant</p> <p>Item # 40347 1 gallon kit</p>	<p>POURS UP TO 1 IN. DEEP</p> <p>Loctite® Fixmaster® Fast Set Grout</p> <p>Item # 1324134 2 gallon kit</p> <p>POURS UP TO 6 IN. DEEP</p> <p>Loctite® Fixmaster® Deep Pour Grout</p> <p>Item # 99545 5 gallon kit</p> <p>POURS UP TO 18 IN. DEEP</p> <p>Loctite® Fixmaster® Super Grout</p> <p>Item # 33510 5 gallon kit</p>	<p>MARINE APPLICATIONS</p> <p>Loctite® Fixmaster® Marine Chocking</p> <p>Item # Green 97572 2 gallon kit Orange 37316 1 gallon kit Orange 96102 2 gallon kit</p> <p>ANCHOR BOLT GROUT</p> <p>Loctite® Fixmaster® Anchor Bolt Grout HP</p> <p>Item # 1108757 8.6 oz. single cartridge 1108758 20.7 oz. dual cartridge</p>

Your Source for
FLOORING & CONCRETE REPAIR
ANTI-SLIP COATINGS

- Provide tough, long-lasting anti-skid surfaces for added safety
- Can be easily applied using Loctite® phenolic or bristle rollers to concrete, metal or wood surfaces
- Stand up to heavy traffic and harsh environments
- For maximum adhesion, use Loctite® Big Foot® primers



[Adhesives / Coatings]

Loctite® Big Foot® Low Profile Pedestrian Grade

A two-component coating that combines water-borne epoxy resins and tough, fine-grained abrasives to produce a self-sealing, non-slip floor and deck coating. Enhanced cleanability, chemical resistance and coverage are but a few of the reasons Loctite® Big Foot® Low Profile Pedestrian Grade is the first choice for low-profile applications.

Item # 40352 1 gallon kit

Loctite® Big Foot® Flexible Low Profile Exterior Grade

Single component, water based anti-slip coating. Designed for barefoot traffic in water prone areas. It is chip-, scuff- and impact-resistant, as well as UV-resistant and flexible. Ideal for recreation areas as well as industrial and institutional facilities.

Item # Grey 1354766 1 gallon kit
 Black 1352349 1 gallon kit

Loctite® Big Foot® Heavy Duty Pedestrian Grade

For areas with heavy pedestrian or light rolling traffic. Ideal for ramps, walkways, locker rooms, stairs and assembly areas. Now available in Safety Yellow.

Item # Black 96211 1 gallon can
 Grey 96261 1 gallon can
 Grey 96265 5 gallon can
 Yellow 40302 1 gallon can
 Yellow 40303 5 gallon can

Loctite® Big Foot® Vehicular Grade

Withstands even the heaviest rolling equipment traffic. Resists liquids as harsh as jet fuels and hydraulic fluids. Superior adhesion forms a solid bond to metal, concrete and wood.

Item # Black 96221 1 gallon kit
 Grey 96251 1 gallon kit
 Grey 96255 5 gallon kit

Loctite® Big Foot® Zero V.O.C.

This 100% reactive, solvent-free epoxy has the most aggressive profile in the Loctite® Big Foot® line. Use in odor-sensitive areas such as wineries, food processing plants, hospitals or for confined spaces.

Item # Grey 39915 1 gallon kit
 Black 96231 1 gallon kit

Loctite® Big Foot® Acrylic Pedestrian Grade

A single-component, elastomeric, anti-slip floor and deck coating or optimum adhesion to asphalt and flexible applications. UV-resistant.

Item # Grey 95591 1 gallon pail
 Black 36045 1 gallon pail

[Primers / Sealers]

Loctite® Big Foot® Metal Primer

Two-component, epoxy-polyamide primer increases adhesion between all Loctite® Big Foot® anti-slip coatings and metal surfaces, including acrylic.

Item # 96132 1 gallon kit

Loctite® Big Foot® Acrylic Primer

A single-component, clear, zero VOCs, water-based primer designed for use with Loctite® Big Foot® Acrylic Pedestrian Grade and Low Profile Exterior Grade.

Item # 95581 1 gallon pail

Loctite® Big Foot® Water-Based Primer/Sealer

Specially formulated to increase adhesion and coverage of all Loctite® Big Foot® anti-slip coatings except Loctite® Big Foot® Acrylic Pedestrian Grade and Low Profile Exterior Grade. For use on concrete, wood, tile and other porous substrates.

Item # 94142 1 gallon kit

COATING ACCESSORIES

Loctite® Big Foot® Phenolic Roller Cores (Heavy Duty, Vehicular, Acrylic Pedestrian, Zero V.O.C.)

Use with Loctite® Big Foot® Heavy Duty Vehicular and Zero V.O.C. Grade Coatings.



Item # 96121 1 per case

Loctite® Big Foot® Bristle Roller Cores

Use with Loctite® Big Foot® Acrylic Primer, Metal Primer and Water-Based Primer / Sealer.

Item # 96153 1 per case



Loctite® Mixer Blades

For use with all 1 gallon kits of Loctite® Big Foot® flooring compounds.

Item # 96131 1 per case



ADDITIONAL RESOURCES

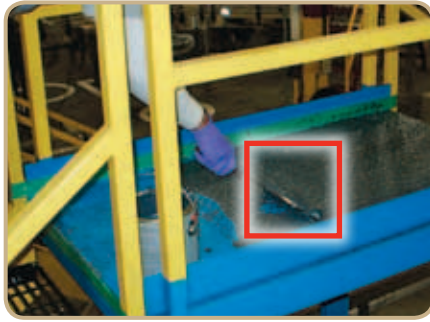

[Applications]

- Ramps
- Loading Docks
- Walkways
- Entryways

[Industries]

- Mining
- Wastewater
- Power Generation
- Municipalities

- Food Processing
- Pulp and Paper
- Beverage

APPLICATIONS & INDUSTRIES

[Loctite® Anti-Slip Properties Chart]

	LOCTITE® PRODUCT	ITEM NUMBER	PACKAGE TYPE/SIZE	COLOR	COVERAGE	MIX RATIO BY WEIGHT (RESIN : HARDENER)	MIX RATIO BY VOLUME (RESIN : HARDENER)	MIXTURE TEMPERATURE	WORK TIME (MINUTES)	FUNCTIONAL CURE (HOURS)*	AGENCY APPROVALS
ADHESIVES/COATINGS	BIG FOOT® LOW PROFILE PEDESTRIAN GRADE	40352	1 gallon kit	Safety Yellow	90 ft. ²	5.7:1	3.7:1	130	60	72	CFIA
	LOCTITE® BIG FOOT® FLEXIBLE LOW PROFILE EXTERIOR GRADE	1354766 1352349	1 gallon kit 1 gallon kit	Grey Black	60 ft. ² per gallon	Single Component	Single Component	140	N/A	24/72	N/A
	BIG FOOT® HEAVY DUTY PEDESTRIAN GRADE	96211	1 gallon can	Black	50 ft. ² per gallon	Single Component	Single Component	140	N/A	12/72	CFIA
		96261 96265	1 gallon can 5 gallon pail	Grey							
		40302 40303	1 gallon can 5 gallon pail	Safety Yellow							
	BIG FOOT® VEHICULAR GRADE	96221 96251 96255	1 gallon kit 1 gallon kit 5 gallon kit	Black Grey Grey	40 ft. ² per gallon	17.6:1	8.9:1	140	120	12/72	CFIA
	BIG FOOT® ZERO V.O.C.	39915 96231	1 gallon kit 1 gallon kit	Grey Black	35 ft. ² per gallon	8.5:1	3.75:1	140	60	24/72	CFIA
BIG FOOT® ACRYLIC PEDESTRIAN GRADE	95591 36045	1 gallon pail 1 gallon pail	Grey Black	70 ft. ²	Single Component	Single Component	140	N/A	4/24	CFIA	
PRIMERS/SEALERS	BIG FOOT® METAL PRIMER	96132	1 gallon kit	Grey	250 ft. ²	3.2:1	3:1	140	240	12	N/A
	BIG FOOT® ACRYLIC PRIMER	95581	1 gallon pail	Clear	250 ft. ²	Single Component	Single Component	140	N/A	1-2	N/A
	BIG FOOT® WATER-BASED PRIMER/SEALER	94142	1 gallon kit	Clear	320 ft. ²	1:1	1:1	140	120	3-6	N/A

ITEMS IN RED = Source's PICK or NEW

* Cure Time is for light pedestrian/heavy pedestrian traffic. Values are temperature- and thickness-specific.

PLEASE NOTE: For best adhesion results, it is critical to follow surface preparation procedures outlined in the Technical Data Sheet for the primer/sealer to be used in your application.

[Loctite® Anti-Slip Application Chart]

LOCTITE® PRODUCT	ASPHALT	WOOD	CONCRETE	METAL	FLEXIBLE COATING	WATER RESISTANT	WATER-BASED	CHEMICAL RESISTANT	ANTI-SLIP (PEDESTRIAN)	ANTI-SLIP (VEHICULAR)	ANTI-SLIP (ZERO V.O.C.)
BIG FOOT® LOW PROFILE PEDESTRIAN GRADE		▲	▲	▲			▲	△	▲		
LOCTITE® BIG FOOT® FLEXIBLE LOW PROFILE EXTERIOR GRADE	▲	▲	▲		▲	▲		△	▲		
BIG FOOT® HEAVY DUTY PEDESTRIAN GRADE		▲	▲	▲				▲	▲	△	
BIG FOOT® VEHICULAR GRADE		▲	▲	▲				▲	△	▲	
BIG FOOT® ZERO V.O.C.		▲	▲	▲				▲	△	△	▲
BIG FOOT® ACRYLIC PEDESTRIAN GRADE	▲	▲	▲	▲	▲	▲			▲		

△ Good Choice ▲ Preferred Choice

USE A PRIMER

- Use a primer before applying any anti-slip coating to increase adhesion and seal porosity on concrete surfaces. See the selector chart at the beginning of this section for assistance in choosing the right primer for your application.

HELPFUL HINTS

Your Source for
FLOORING & CONCRETE REPAIR
FLOOR SEALANTS
& TOPCOATS



[Topcoats]

Loctite® Fixmaster® Self-Leveling Flooring Epoxy and Loctite® Fixmaster® High Build Self-Leveling Flooring Epoxy

A two-component, 100% solids, high performance, self-leveling floor coating. A high gloss, seamless, hygienic surface that is extremely hard-wearing and durable. Zero VOC's and extremely low odor. Offers high chemical resistance and is available in Clear, Haze and Deck Gray, Sandstone and Tile Red.

Recommended coating system is:

First Coat: Loctite® Fixmaster® High Solids Floor Coating Primer or Loctite® Fixmaster® Water-Based Epoxy Primer/Sealer

Second Coat: Loctite® Fixmaster® Self-Leveling Flooring Epoxy or Loctite® Fixmaster® High Build Self-Leveling Flooring Epoxy

Item #	40332	Deck Grey	Complete 1 gallon kit
	40334	Haze Grey	Complete 1 gallon kit
	40342	Standard	1.5 gallon Hardener*
	40333	Deck Grey	3.5 gallon Resin**
	40335	Haze Grey	3.5 gallon Resin**

* Needs Clear or Color Resin.
 ** A Hardener must be added.

[Primers / Sealers]

Loctite® Fixmaster® Water-Based Epoxy Primer/Sealer

Two-component, clear, water-based primer. Low viscosity for maximum penetration. Effective barrier coat over many existing finishes. Easy to apply. Excellent for use over acid-etched concrete.

Item #	40348	Complete	2 gallon kit
	40349	Must have Hardener	10 gallon Resin
	40351	Must have Resin	10 gallon Hardener

Loctite® Fixmaster® High Solids Floor Coating Primer

Clear, high solids, fast curing, penetrating primer. Low odor, VOC-compliant. High build, low viscosity for use over mechanically prepared substrates (shot blast). Reduces bubbling and pinholes that occur when coating porous substrates.

Item #	40319	Clear	1 gallon kit
	40320	Clear Resin	3.5 gallon
	40321	Clear Hardener	1.5 gallon

* Needs Clear or Color Resin.
 ** A Hardener must be added.

Sources REVEALED

APPLICATIONS

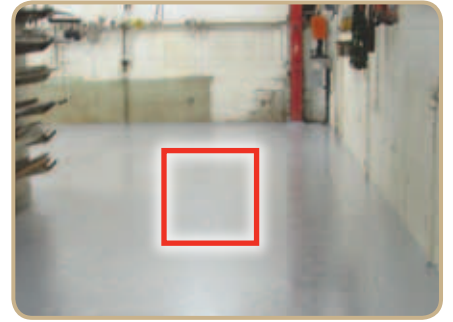
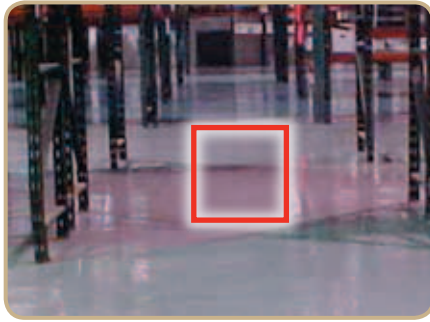

[Applications]

- New or Old Concrete
- Masonry
- Wood
- Metal

[Loctite® Floor Sealants & Topcoats Properties Chart]

	LOCTITE® PRODUCT	ITEM NUMBER	PACKAGE TYPE/SIZE	COLOR	COVERAGE	CURE TIME	RECOAT TIME
TOPCOATS	FIXMASTER® SELF-LEVELING FLOORING EPOXY	40332	Complete 1 gallon kit	Deck Grey	110 ft. ²	24 hours per foot 72 hours full cure	8 to 16 hours
		40334	Complete 1 gallon kit	Haze Grey			
		40342	1.5 gallon Hardener	Standard			
		40333	3.5 gallon Resin*	Deck Grey			
		40335	3.5 gallon Resin*	Haze Grey			
PRIMER / SEALERS	FIXMASTER® WATER-BASED EPOXY PRIMER / SEALER	40348	2 gallon kit (Complete)	Clear	250 ft. ²	N/A	6 to 48 hours
		40349	10 gallon Resin (Must have Hardener)				
		40351	10 gallon Hardener (Must have Resin)				
	FIXMASTER® HIGH SOLIDS FLOOR COATING PRIMER	40319	1 gallon kit	Clear	200 ft. ²	N/A	8 to 36 hours
40320		3.5 gallon					
40321		1.5 gallon					

ITEMS IN RED = Source's PICK or NEW

Your Source for
FLOORING & CONCRETE REPAIR
FLOORING, CONCRETE
REPAIR & GROUTING



[Grouts]

Loctite® Fixmaster® Deep Pour Grout

Aggregate-filled, epoxy system for pours up to 6 inches deep, including self-leveling applications under rails and soleplates. High strength material bonds to steel, concrete and itself. Withstands high torque loading.

Item # 99545 5 gallon kit

Loctite® Fixmaster® Fast Set Grout

Self-leveling, non-shrinking grout for installing machinery and setting anchor bolts. Cures quickly. Can be poured up to 1 inch thick. Compression strength and chemical resistance are superior to concrete. Forms strong bonds to old concrete and to itself.

Item # 1324134 2 gallon kit

Loctite® Fixmaster® Super Grout

Aggregate-filled epoxy system designed for grouting up to 18 inches deep, including self-leveling applications under rails and soleplates under typical dry service temperatures of -20°F to 225°F (-29°C to 107°C). A 100% solids epoxy system that is non-shrinking, chemical and corrosion resistant, stronger than concrete, and withstands high torque loading.

Item # 33510 5 gallon kit

Loctite® Fixmaster® Anchor Bolt Grout and Anchor Bolt Grout HP

This two-part structural epoxy is solvent-free, odor-free, high strength and non-sag. It is formulated to anchor threaded rods, bolts, rebar and smooth dowels into concrete, grout-filled block and masonry. The high performance (HP) product offers greater tension load capacity.

Item # 1108885 20.7 oz. dual cartridge
 1108757 8.6 oz. single cartridge HP
 1108758 20.7 oz. dual cartridge HP

[Floor Repair & Resurfacing]

Loctite® Fixmaster® High Performance Quartz

Trowelable epoxy for repairing and protecting floors exposed to concentrated acids, alkalis and solvents. Recommended for restoring and protecting old concrete.

Item # 96495 42 lb. kit

Loctite® Fixmaster® Floor Fill

Self-leveling for repairing and resurfacing cracks in concrete floors. Bonds to old and new concrete, and provides greater strength and chemical resistance properties. Typical dry service temperatures range from -15°F to 130°F (-26°C to 54°C).

Item # 99361 10 lb. kit
 99365 40 lb. kit



Your Source for **FLOOR FILL** Loctite® Fixmaster® Floor Fill 6-Step Process

Loctite® Heavy Duty Manual Cartridge Applicators

The non-sag, high viscosity formulas of Loctite® Fixmaster® Crack Filler NS, Anchor Bolt Grout and Anchor Bolt Grout HP require a heavy-duty dispensing tool.

Item # 1093940 Use with 300 ml cartridges
 1093981 Use with 600 ml dual cartridges

CONSUMABLES – DISPENSE ACCESSORIES
 Static Mix Nozzles and Accessories – Pages 185-186

ADDITIONAL RESOURCES



[Applications]

- Pump
- Gearbox
- Concrete Repair
- Conveyor Systems
- Shaft Repair

[Industries]

- Mining
- Wastewater
- Power Generation

- Food Processing
- Pulp and Paper
- Beverage

APPLICATIONS
& INDUSTRIES

Loctite® Fixmaster® Magna-Crete™

A two-component, rapid-setting concrete repair and grouting system. Chemically resistant to most common liquids and chemicals, and can be mixed and applied at temperatures from -15°F to 130°F (-26°C to 54°C). Bonds to concrete, wood, glass, steel and other construction materials. Ready for service in one hour. Summer and Winter Additives are also available to aid cure times.

Item #	95551	1 gallon kit
	95555	5 gallon kit
	1012500	1 lb. 12 oz. kit
	831304	2475 lb. tote
	976786	55 gallon drum – Activator
	40270	1 lb. tub – Winter Additive
	40271	1 lb. tub – Summer Additive

Loctite® Fixmaster® Magna-Grout™

A two-component, rapid-setting concrete repair and grouting system with the same properties as Magna-Crete™ but containing smaller aggregate (less than 1/4 in.) so that the mixed material can be poured thinner for resurfacing applications and feather edging.

Item #	1477097	1 gallon kit
	1476710	5 gallon kit
	1476709	2,475 lb. tote
	40270	1 lb. tub – Winter Additive
	40271	1 lb. tub – Summer Additive

Loctite® Fixmaster® Flexible Joint Sealant

A two-component, pourable, urethane-based sealant that is 100% solids and contains no solvents. Excellent adhesion, high chemical resistance and excellent tensile strength, flexibility and elongation for expansion and control joints.

Item # 40347 1 gallon kit

Loctite® Fixmaster® Concrete Repair Epoxy

Enables permanent repairs to concrete and masonry. Convenient stick contains pre-measured portions of activator and base. Once cured, it can be tapped, drilled, screwed, sawed, filed or painted, and will have an appearance and texture similar to concrete. Sets in 5-10 minutes.

Item # 39366 4 oz. stick

Loctite® Fixmaster® Crack Filler

A two-component, natural in color, epoxy repair adhesive that is 100% solids and contains no solvents. It has excellent workability and flow. Fills cracks in concrete, wood, masonry and previously coated surfaces.

Item # 40346 1 gallon kit

Loctite® Fixmaster® Crack Filler NS

Non-drip, non-sag formula will repair holes, spalls and cracks in concrete, brick, block and masonry on horizontal or vertical surfaces. This two-part, rapid-curing, high strength epoxy will not soften over time and can be used indoors or outdoors.

Item # 1108886 8.6 oz. cartridge

Loctite® Fixmaster® Crack Filler SL

Two-component, self-leveling, flexible formula in a coaxial cartridge. Can be used indoors or outdoors. Bonds concrete, block, brick, stone, wood and metal.

Item # 1291113 8.6 oz. cartridge

[Chocking Compound]

Loctite® Fixmaster® Marine Chocking

Self-leveling, fast curing, non-shrinking grout. Outstanding chemical and vibration resistance and compressive strength to withstand maximum loads.

Item # Green 97572 2 gallon kit
Orange 37316 1 gallon kit
Orange 96102 2 gallon kit

- When checking for damaged concrete, tap around the repair area with a hammer and listen for hollow spots. This will help to reveal damaged areas that are not apparent.
- Use Loctite® Fixmaster® Magna-Crete™ Summer Additive or Winter Additive with Loctite® Fixmaster® Magna-Crete™ to accelerate or slow the cure in high temperature or speed the cure in low temperature environments.

HELPFUL HINTS



Your Source for **CONCRETE REPAIR**
Loctite® Fixmaster® Concrete Repair Epoxy 3-Step Process

Your Source for
FLOORING & CONCRETE REPAIR
FLOORING, CONCRETE
REPAIR & GROUTING



[Loctite® Flooring, Concrete Repair & Grouting Properties Chart]

	LOCTITE® PRODUCT	ITEM NUMBER	PACKAGE TYPE/SIZE	COLOR	COVERAGE	MIXTURE VISCOSITY (cP)	MAXIMUM TEMPERATURE	COMPRESSIVE STRENGTH (psi)	WORKING TIME	FUNCTIONAL CURE	MIX RATIO BY VOLUME (RESIN : HARDENER)	MIX RATIO BY WEIGHT (RESIN : HARDENER)	AGENCY APPROVALS
GROUTS	FIXMASTER® DEEP POUR GROUT	99545	5 gallon kit	Black	660 in. ³	Pourable	225	14,500	30 minutes	24 hours	4.1:1 to 8.2 Filler	16.4:3.6 to 80 Filler	CFIA
	FIXMASTER® FAST SET GROUT	1324134	2 gallon kit	Red	347 in. ³	5,500	200	14,500	10 minutes	12 hours	100:11.7	100:6.5	CFIA
	FIXMASTER® SUPER GROUT	33510	5 gallon kit	Red	620 in. ³	Pourable	225	12,900	4.75 hours	24 hours	N/A	10:5 to 85 Aggregate	N/A
ANCHOR BOLT GROUT	FIXMASTER® ANCHOR BOLT GROUT HP	1108757 1108758	8.6 oz. single cartridge 20.7 oz. dual cartridge	Grey	15.5 in. ³ 37.36 in. ³	N/A	110 115	9,880	20 minutes	4 hours	1:1	N/A	N/A
	FIXMASTER® ANCHOR BOLT GROUT	1108885	20.7 oz. dual cartridge	Grey	37.36 in. ³	N/A	110	11,890	20 minutes	2 hours	1:1	N/A	N/A
FLOOR REPAIR & RESURFACING	FIXMASTER® HIGH PERFORMANCE QUARTZ (EXTREME CHEMICAL RESISTANCE)	96495	42 lb. kit	Grey	15 ft. ² (Coverage at 1/4 in. thickness.)	Semi-Pourable	150	12,000	Primer - 45 minutes Topcoat - 60 minutes	24 hours	Primer - 100:61 Topcoat - 100:60 to 282 Filler	N/A	CFIA
	FIXMASTER® FLOOR FILL	99361 99365	10 lb. kit 40 lb. kit	Grey	133 in. ³ 532 in. ³	Semi-Pourable	225	15,000	40 minutes	24 hours	4.6:1 to 9.8 Filler	16.3:2 to 80.8 Filler	CFIA
	FIXMASTER® MAGNA-CRETE™	95551 95555 1012500 831304 976786	1 gallon kit 5 gallon kit 1 lb. 12 oz. kit 2,475 lb. tote 55 gallon drum - Activator	Grey	170 in. ³ 770 in. ³	N/A	2,000	13,000	5 to 20 minutes	1 to 2 hours	N/A	N/A	CFIA
	FIXMASTER® MAGNA-GROUT™	1477079 1476710 1476709	1 gallon kit 5 gallon kit 2,475 lb. tote	Grey	170 in. ³ 770 in. ³	N/A	2,000	13,000	5 to 20 minutes	1 to 2 hours	N/A	N/A	CFIA
	ADDITIVES FOR MAGNA-CRETE™ AND MAGNA-GROUT™	40270 40271	1 lb. tub for Winter Use 1 lb. tub for Summer Use	White	N/A	N/A	2,000	13,000	5 to 20 minutes	(+) 10 minutes (-) 10 minutes	N/A	N/A	CFIA
	FIXMASTER® MAGNA-CRETE™ ACTIVATOR	36334	10 lb. bottle	N/A	N/A	N/A	N/A	N/A	N/A	N/A	N/A	N/A	N/A
	FIXMASTER® CONCRETE REPAIR EPOXY	39366	4 oz. stick	Grey	N/A	Putty	250	12,000	4 to 7 minutes	1 hour	N/A	N/A	N/A
	FIXMASTER® FLEXIBLE JOINT SEALANT	40347	1 gallon kit	Grey	231 in. ³	17,000	180	N/A	30 minutes	6 hours	1:1	N/A	N/A
	FIXMASTER® CRACK FILLER	40346	1 gallon kit	Off-White	231 in. ³	80,000	180	N/A	30 minutes	6 hours	1:1	N/A	N/A
	FIXMASTER® CRACK FILLER NS	1108886	8.6 oz. cartridge	Grey	15.5 in. ³	N/A	135°F (57°C)	9,800	8 minutes	2 hours	1:1	N/A	N/A
FIXMASTER® CRACK FILLER SL	1291113	8.6 oz. cartridge	Grey	15.5 in. ³	N/A	120°F (49°C)	9,800	3 to 6 minutes	90 minutes	1:1	N/A	N/A	
CHOCKING COMPOUND	FIXMASTER® MARINE CHOCKING	97572 37316 96102	2 gallon kit 1 gallon kit 2 gallon kit	Green Orange	378 in. ³ 132 in. ³ 378 in. ³	15,000	250	22,000	10 minutes	24 hours	100:11.6	100:6.9	ABS, CFIA, Lloyd's ABS, Lloyd's, NAVSEA, NEHC

[Loctite® Flooring, Concrete Repair & Grouting Application Chart]

LOCTITE® PRODUCT	ANCHOR BOLT FASTENING	CHOCKING (SHIPS)	CONCRETE FLOOR REPAIR	NON-SAG CONCRETE REPAIR	ENGINE INSTALLATION	GROUT HEAVY EQUIPMENT 1-6 IN.	GROUT HEAVY EQUIPMENT TO 18 IN.	GROUT LIGHT EQUIPMENT 1 IN. OR LESS	LEVELING EQUIPMENT	ACID/CHEMICAL RESISTANT FLOOR REPAIR	RAMPS & LOADING DOCKS	HIGHWAYS & ROADWAYS	LEVELING FLOORS
GROUTS	FIXMASTER® DEEP POUR GROUT				△	▲		△	△				
	FIXMASTER® FAST SET GROUT				△	△		▲	▲				
	FIXMASTER® SUPER GROUT				△	△	▲		△				
ANCHOR BOLT GROUT	FIXMASTER® ANCHOR BOLT GROUT & FIXMASTER® ANCHOR BOLT GROUT HP	▲											
FLOOR REPAIR & RESURFACING	FIXMASTER® HIGH PERFORMANCE QUARTZ (EXTREME CHEMICAL RESISTANCE)		△							▲			
	FIXMASTER® FLOOR FILL		▲		△					△			
	FIXMASTER® MAGNA-CRETE™		▲			△		△			▲	▲	▲
	FIXMASTER® MAGNA-GROUT™			▲		△		△			▲	▲	▲
	FIXMASTER® CONCRETE REPAIR EPOXY	▲		▲					△	△	▲		
	FIXMASTER® FLEXIBLE JOINT SEALANT			▲						▲			
	FIXMASTER® CRACK FILLER			▲						▲			
	FIXMASTER® CRACK FILLER SL			▲						▲			
	FIXMASTER® CRACK FILLER NS				▲								
	CHOCKING COMPOUND	FIXMASTER® MARINE CHOCKING		▲		▲			△	△			

ITEMS IN RED = Source's PICK or NEW

△ Good Choice ▲ Preferred Choice

Your Source for
**GASKETING
 & SEALING**

[Table of Contents]

GASKETING & SEALING	73
ANAEROBICS	75
ANAEROBIC EQUIPMENT	78
ELASTOMERIC ADHESIVES & SEALANTS	79
ELASTOMERIC EQUIPMENT	80
SILICONE ADHESIVES & SEALANTS	81
SILICONE ADHESIVES & SEALANTS EQUIPMENT	88

Loctite® Adhesives and Sealants Product Specialists are available to assist you with new product designs, or to help you re-engineer an existing application for improved performance and cost savings. They can also set up testing of your parts at the Henkel Customer Engineering Center. For application assistance, call **1-800-LOCTITE (562-8483)**; *within Canada, call 1-800-263-5043*; or, contact us through the web at www.henkelna.com/loctite.

STRAIGHT FROM *The Source*

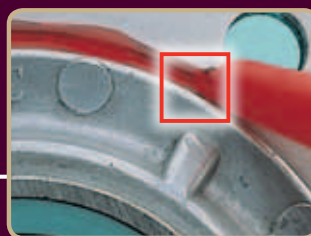

Gaskets are used to prevent fluid or gas leaks by forming impervious barriers that remain intact and leak-free over a prolonged period of time. The gasket must resist the fluid and/or gaseous medium being sealed or excluded and withstand the operating temperatures and pressures to which it is subjected.

THERE ARE THREE TYPES OF FLANGE GASKETS

1. Conventional pre-cut compression gaskets are made from paper, rubber, cork, metal or other materials.
2. Formed-in-Place (FIP) gaskets are applied as a liquid sealant to one of the flange surfaces before the parts are assembled. After assembly, the FIP gasket spreads and cures between the flanges, filling gaps, scratches and surface irregularities to provide a durable seal.
3. Cured-in-Place (CIP) gaskets are liquids that are applied by machines. These machines dispense the gasket material in precise beads to one of the flanges. The material is cured by ultraviolet (UV) light to form an elastomeric material with adhesion to the flange surface. Sealing is achieved through compression of the cured gasket during flange assembly.

WHAT IS THE BEST GASKET FOR MY APPLICATION?

Many factors influence gasket choice. The following chart is intended to serve as a general guideline to help you determine which gasket type is best suited for your application. The data presented herein reflects typical properties for each gasket type; however, there may be exceptions to the data presented. Individual product information can then be found on the following pages and will help you narrow your search.

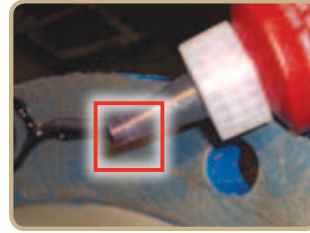
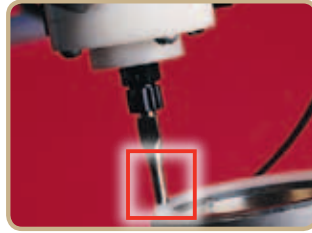

Your Source GASKETING & SEALING GUIDE

GENERAL COMPARISON	GASKET TYPE				
	CONVENTIONAL GASKET DRESSINGS	CURED-IN-PLACE SILICONES	FORMED-IN-PLACE ANAEROBICS	FORMED-IN-PLACE MODIFIED SILANES	FORMED-IN-PLACE SILICONES
BENEFITS	Versatile, immediate green strength (sticky)	High gap filling, reusable/serviceable gasket, immediate fill properties	Improved structural strength, long open time, high pressure seal	High gap filling, improved strength/adhesion over silicones, paintable	High gap filling, resistant to dynamic fatigue, on-line pressure testing
LIMITATIONS	Non-curing, limited gap fill, % shrinkage	Requires process equipment	Limited fill	Limited temperature performance	Short open time
PROCESS CONSIDERATIONS	GASKET TYPE				
	CONVENTIONAL GASKET DRESSINGS	CURED-IN-PLACE SILICONES	FORMED-IN-PLACE ANAEROBICS	FORMED-IN-PLACE MODIFIED SILANES	FORMED-IN-PLACE SILICONES
TEMPERATURE RESISTANCE					
CONTINUOUS OPERATION	-65°F to +400°F (-54°C to +204°C)	-60°F to +400°F (-51°C to +204°C)	-40°F to +300°F (-40°C to +149°C)	-40°F to +200°F (-40°C to +93°C)	-60°F to +400°F (-51°C to +204°C)
MAXIMUM	+600°F (+315°C)	+500°F (+260°C)	+400°F (+204°C)	+200°F (+93°C)	+725°F (+385°C)
FLUID RESISTANCE					
OIL	Yes	Yes	Yes	Limited	Yes
WATER/GLYCOL	Yes	Yes	Yes	Yes	Yes
FUEL	Limited	No	Limited	Limited	No
TRANSMISSION FLUID	Yes	Yes	Yes	Limited	Yes
GAP FILL					
IDEAL	0.001 in. to 0.005 in.	0.020 in. to 0.125 in.	0.001 in. to 0.005 in.	0.001 in. to 0.125 in.	0.001 in. to 0.125 in.
MAXIMUM	0.010 in.	0.240 in.	0.050 in.	0.240 in.	0.240 in.
INSTANT SEAL	High Pressure	High Pressure	Low Pressure	Low Pressure	Low Pressure
FLANGE TYPE	Rigid or Flexible	Rigid or Flexible	Rigid	Rigid or Flexible	Rigid or Flexible
SUITABLE FOR USE WITH:					
METALS	Yes	Yes	Yes	Yes	Yes
PLASTICS*	Yes	Yes	No	Yes	Yes
PROCESS CONSIDERATIONS	GASKET TYPE				
	CONVENTIONAL GASKET DRESSINGS	CURED-IN-PLACE SILICONES	FORMED-IN-PLACE ANAEROBICS	FORMED-IN-PLACE MODIFIED SILANES	FORMED-IN-PLACE SILICONES
NUMBER OF COMPONENTS	1	1	1	1	1
CURE METHOD	N/A	UV/RTV	Anaerobic	Moisture	RTV
CURE TEMPERATURE	Room Temperature	Room Temperature	Room Temperature	Room Temperature	Room Temperature
CURE SPEED					
INITIAL CURE	Immediate	15 to 30 seconds	15 to 30 minutes	15 to 30 minutes	15 to 30 minutes
FULL CURE	N/A	30 seconds	24 to 72 hours	1 to 7 days	1 to 7 days
PROCESSING OPTIONS					
MANUAL	Yes	No	Yes	Yes	Yes
AUTOMATED	No	Yes	Yes	Yes	Yes

* Uncured liquid adhesives may cause stress cracking of certain thermoplastics (e.g., polycarbons, acrylics and polysulfone). Special products and process techniques are available. Consult the Loctite® Design Guide to Bonding Plastics (LI-2197) or call 1-800-(562-8483) for more information.

PLEASE NOTE: This chart should not be used to specify products without specific testing. It is recommended that you conduct on-part testing to ensure product performance before specifying any gasketing product.

Your Source for
GASKETING & SEALING
ANAEROBICS

- Revolutionized flange sealing in the automotive industry, the assembly of heavy equipment and the manufacture of various types of fluid power equipment
- Remains a liquid when exposed to air, but cures when confined between mating flanges
- Best suited for small gap applications and rigid metal-to-metal assemblies

[Rigid Assembly
Flange Sealants]

**Loctite® 504™ Gasket
Eliminator® Flange Sealant**

GAP FILLING

A single-component, instant, low pressure flange sealant that fills gaps to 0.050 in. (1.27 mm).

Item #	50441	250 ml tube
	50480	300 ml cartridge

**Loctite® 509™ Gasket
Eliminator® Flange Sealant**

FLEXIBLE

Product withstands minor flange movements caused by vibrations. It will not run when applied to vertical surfaces. Fluorescent blue properties allow visual inspection during assembly.

Item #	21525	300 ml cartridge
	50965	850 ml cartridge

**Loctite® 510™ Gasket
Eliminator® Flange Sealant**

HIGH TEMPERATURE

Product withstands temperatures to 400°F (204°C) and has excellent solvent and chemical resistance. Fills gaps up to 0.010 in. (0.254 mm) and maintains clamping loads for strong, leakproof assemblies. Makes or dresses gaskets in rigid assemblies. Eliminates gasket compression set.

Item #	51031	50 ml tube
	51041	250 ml tube
	51074	300 ml cartridge

Source's PICK

**Loctite® 515™ Gasket
Eliminator® Flange Sealant**

Makes flexible gaskets for rigid machined flanges with less than 0.050 in. (1.27 mm) gap. Flexes when flanges move in service.

Item #	51517	6 ml tube
	51531	50 ml tube
	51580	300 ml cartridge

**Loctite® 518™ Gasket
Eliminator® Flange Sealant**

Forms a flexible, solvent-resistant seal that will not tear or decay. Seals to 300°F (149°C) and fills gaps to 0.050 in. (1.27 mm). Can be used on flexible metal assemblies, including aluminum surfaces. Easy disassembly and cleaning. Ideal for on-the-spot and emergency repairs, or when a conventional gasket is out of stock.

Item #	22423	25 ml syringe kit
	22424	300 ml syringe kit
	51817	6 ml tube
	51831	50 ml tube
	51845	300 ml cartridge

**Loctite® QuickStix® 548™ Gasket
Eliminator® Flange Sealant**

Patented, semisolid formula is ideal for on-the-spot repairs, or when a conventional gasket is out of stock. Can be applied quickly and neatly on a variety of metal surfaces, including aluminum, to form a solvent-resistant seal. Seals to 300°F (149°C) and fills gaps to 0.010 in. (0.254 mm).

Item #	39152	18 g stick
--------	-------	------------

[Low Strength – Easy Removal]

Loctite® 5203™ Flange Sealant

EXCELLENT SEAL, LOW ADHESION

Seals close-fitting joints between rigid metal flanges. Provides immediate resistance to low pressures and cures rapidly. Fully cured product can be easily removed, particularly from aluminum.

Item #	1317148	300 ml cartridge
--------	---------	------------------

[Highly Flexible
Anaerobic Gasket]

**Loctite® 5188™ Flexible
Flange Sealant**

HIGHLY FLEXIBLE

A highly flexible, medium-to-high strength, anaerobic gasketing material, which shows excellent adhesion on aluminum. This product is designed to function in the most demanding power train applications with superior adhesion and flexibility, even after heat aging.

Item #	1241991	300 ml cartridge
	1253203	50 ml tube
	98128	Loctite® cartridge dispense tip

[Sealants / Dressings for
Existing Gaskets]

**Loctite® QuickStix® 534™
Hi-Tack Gasket Dressing**

No mess, semisolid formula offers added control and ease of use. Patented package is portable and won't leak or spill. Seals and holds the heaviest gaskets during assembly. Solvent-free and low odor. Suitable to 300°F (149°C).

Item #	39156	19 g stick
--------	-------	------------



APPLICATIONS

[Applications]

- Gear Boxes
- Pumps
- Engines

Loctite® Gasket Sealant 1 (Solvent-Based)

Reliable, paste-like gasket sealant, dressing and coating. Sets quickly to a hard set and is recommended for rigid, permanent assemblies. Use to 400°F (204°C). Resistant to gasoline and other solvents.

Item #	30510	1.5 oz. tube
	30511	3 oz. tube
	30512	7 fl. oz. tube

Loctite® Gasket Sealant 2 (Solvent-Based)

Reliable, paste-like gasket sealant, dressing and coating. Sets slowly to a pliable film. Best suited for non-rigid, vibrating assemblies. Use to 400°F (204°C). Resistant to gasoline and other solvents.

Item #	30513	1.5 oz. tube
	30514	3 oz. tube
	30515	7 fl. oz. tube
	80964	5 gallon can

Loctite® High Temperature Gasket Maker (Solvent-Based)

Slow-setting, non-hardening, high temperature sealant. Recommended for heavy-duty applications. Temperature range is -50°F to 600°F (-46°C to 315°C) intermittent. Resists common shop fluids.

Item #	30558	7 fl. oz. tube
--------	-------	----------------

Loctite® Hi-Tack Gasket Sealant (Solvent-Based)

Red-colored, liquid sealant that holds gaskets in place during assembly. Seals and bonds rubber, cork, paper, felt, metal and asbestos gaskets. Sets quickly to a very tacky film. Suitable to 500°F (260°C). Contains no ozone-depleting compounds.

Item #	30524	0.25 pt. brush can
	30525	1 pint brush can
	30526	9 oz. net wt. aerosol

Loctite® Aviation Gasket Sealant (Solvent-Based)

Reliable, liquid gasket sealant, dressing and coating. Thin brushable dressing or sealant for close-fitting parts. Use to 400°F (204°C). Resistant to gasoline and other solvents.

Item #	30517	0.25 pt. brush can
	30516	1 pint brush can

Loctite® Copper Gasket Adhesive (Solvent-Based)

Fast drying, metallic, copper sealant helps dissipate heat, prevent gasket burnout and improve heat transfer. Fills hot spots and surface imperfections. Temperature range is -50°F to 500°F (-45°C to 260°C). Resists shop fluids.

Item #	30535	9 oz. net wt. aerosol
--------	-------	-----------------------

[Loctite® Gasketing & Sealing Anaerobics Attributes & Application Chart]

	LOCTITE® PRODUCT	MAIN ATTRIBUTES	APPLICATIONS
RIGID ASSEMBLY FLANGE SEALANTS	504™ GASKET ELIMINATOR® FLANGE SEALANT	Rigid, low viscosity, self-shimming, 0.030 in. gap fill without primer	Rigid flange applications
	509™ GASKET ELIMINATOR® FLANGE SEALANT	Flexible at temperatures up to 300°F (149°C), fluorescent, blue	Gearbox, engine casings
	510™ GASKET ELIMINATOR® FLANGE SEALANT	Resists low on-line test pressures, uncured	General gasketing
	515™ GASKET ELIMINATOR® FLANGE SEALANT	Flexes with flanges that move in service	General gasketing
	518™ GASKET ELIMINATOR® FLANGE SEALANT	Resists low on-line test pressures, uncured	Gearbox, engine casting
SEALANT / DRESSING FOR EXISTING GASKETS	QUICKSTIX® 534™ HI-TACK GASKET SEALANT	Vertical applications, uses less product, repositionable	Holds gaskets in place (rubber, cork, paper, felt and metal)
	GASKET SEALANT 1 (SOLVENT-BASED)	Extended gasket life, fast drying, rigid cure	Threaded connections, air ducts, plumbing connections
	GASKET SEALANT 2 (SOLVENT-BASED)	Extended gasket life, slow drying, flexible cure	Valve cover and oil pan gaskets, threaded connections
	HIGH TEMPERATURE GASKET MAKER (SOLVENT-BASED)	Reliability at high temperatures, seals up to 5,000 psi	Aircraft heating systems, steam lines
	HI-TACK GASKET SEALANT (SOLVENT-BASED)	Prevents seizing, corrects gasket alignment, easy disassembly	Weather stripping, waterproofing electrical connections
	AVIATION GASKET SEALANT (SOLVENT-BASED)	Close tolerance flanges, slow drying, flexible cure	Aviation and marine engines, threaded connections
	COPPER GASKET ADHESIVE (SOLVENT-BASED)	Improved heat transfer, fills surface imperfections, repositionable	Cylinder head, exhaust manifolds, turbo charger flanges, carburetor gaskets

ITEMS IN RED = Source's PICK or NEW

Your Source for
GASKETING & SEALING
ANAEROBICS

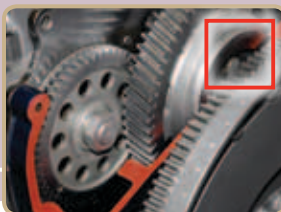

[Loctite® Rigid Assembly Gasketing Products Properties Chart]

LOCTITE® PRODUCT	ITEM NUMBER	PACKAGE TYPE/SIZE	COLOR	TYPICAL USE	GAP FILL (INCHES)	CURED STATE	VISCOSITY (cP)	TEMPERATURE RANGE	CURE SPEED	RECOMMENDED PRIMER	SPECIFIC GRAVITY	AGENCY APPROVALS	
504™ GASKET ELIMINATOR®	50441 50480	250 ml tube 300 ml cartridge	Orange	Gap filling	Unprimed – 0.030 Primed – 0.050	Rigid	500,000/ 1,200,000 Thixotropic	-65°F to 300°F (-54°C to 149°C)	Unprimed – 4 to 24 hours Primed – 30 minutes to 4 hours	N™ or T™	1.08	N/A	
509™ GASKET ELIMINATOR®	21525 50965	300 ml cartridge 850 ml cartridge	Blue	Very flexible	Unprimed – 0.010 Primed – 0.020	Flexible	65,000/ 200,000 Thixotropic	-65°F to 300°F (-54°C to 149°C)	Unprimed – 6 to 48 hours Primed – 1 to 6 hours	N™	1.12	N/A	
510™ GASKET ELIMINATOR®	51031 51041 51074	50 ml tube 250 ml tube 300 ml cartridge	Red	High temperature applications, excellent solvent resistance	Unprimed – 0.010 Primed – 0.020	Rigid	188,000/ 500,000 Thixotropic	-65°F to 400°F (-54°C to 204°C)	Unprimed – 4 to 24 hours Primed – 30 minutes to 4 hours	N™	1.16	N/A	
515™ GASKET ELIMINATOR®	51517 51531 51580	6 ml tube 50 ml tube 300 ml cartridge	Purple	For flexible applications	Unprimed – 0.010 Primed – 0.050	Flexible	275,000/ 950,000 Thixotropic	-65°F to 300°F (-54°C to 149°C)	Unprimed – 1 to 12 hours Primed – 15 minutes to 2 hours	N™	1.10	UL Classified for U.S.	
518™ GASKET ELIMINATOR®	22423 22424 51817 51831 51845	25 ml syringe kit 300 ml syringe kit 6 ml tube 50 ml tube 300 ml cartridge	Red	For all metals, including aluminum flanges	Unprimed – 0.010 Primed – 0.050	Flexible	800,000/ 3,750,000 Thixotropic	-65°F to 300°F (-54°C to 149°C)	Unprimed – 4 to 24 hours Primed – 30 minutes to 4 hours	N™	1.13	NSF®/ ANSI 61, CFIA	
QUICKSTIX® 548™ GASKET ELIMINATOR	39152	18 g stick	Orange	On-the-spot repairs, for all metals, including aluminum	0.010"	Flexible	Semi-solid	-65°F to 300°F (-54°C to 149°C)	Unprimed – 6 to 24 hours Primed – 3 to 6 hours	N™ or T™	1.13	N/A	
549™	54941	250 ml tube	Orange	Instant seal plastic gasket	Unprimed – 0.020 Primed – 0.050	Rigid	22,500	-65°F to 300°F (-54°C to 149°C)	Unprimed – 6 to 24 hours Primed – 2 to 24 hours	N™ or T™	1.25	N/A	
568™	56841	250 ml tube	Orange	Plastic gasket	Unprimed – 0.015 Primed – 0.050	Rigid	6,500	-65°F to 300°F (-54°C to 149°C)	Unprimed – 12 to 24 hours Primed – 2 to 24 hours	N™ or T™	1.12	N/A	
573™	26392	250 ml tube	Green	Slow curing for extended assembly operations	Unprimed – 0.010 Primed – 0.020	Semi-Rigid	19,000/ 60,000 Thixotropic	-65°F to 300°F (-54°C to 149°C)	Unprimed – 6 to 48 hours Primed – 1 to 6 hours	N™	1.25	N/A	
574™	24018 26338	50 ml tube 250 ml tube	Orange	Fast curing, large gaps	Unprimed – 0.010 Primed – 0.020	Semi-Rigid	30,000/ 100,000 Thixotropic	-65°F to 300°F (-54°C to 149°C)	Unprimed – 1 to 12 hours Primed – 15 minutes to 2 hours	N™	1.11	N/A	
5127™	17430	300 ml cartridge	Blue	For flexible applications, high elongation	0.010	Flexible	100,000/ 500,000 Thixotropic	-65°F to 300°F (-54°C to 149°C)	Unprimed – 4 to 24 hours Primed – 1 to 24 hours	N™	1.10	N/A	
HIGHLY FLEXIBLE	5188™	1241991 1253203 98128	300 ml cartridge 50 ml tube Cartridge dispense tip	Red	Rigid metal flanges	0.005	Rigid	14,000 - 32,000	-65°F to 300°F (-54°C to 149°C)	24 hours @ room temperature	N™	1.10	N/A
LOW STRENGTH	5203™	1317148	300 ml cartridge	Red	Rigid metal flanges	0.010	Rigid	50,000 - 100,000	-65°F to 300°F (-54°C to 149°C)	24 hours @ room temperature	N™	1.09	N/A



ITEMS IN RED = Source's PICK or NEW = Indicates Worldwide Availability

[Loctite® Sealing / Dressings for Existing Gaskets Properties Chart]

LOCTITE® PRODUCT	ITEM NUMBER	PACKAGE TYPE/SIZE	COLOR	TYPICAL USE	CONSISTENCY	VISCOSITY (cP)	TEMPERATURE RANGE	CURE SPEED	OIL RESISTANCE	AGENCY APPROVALS	
SEALING / DRESSINGS FOR EXISTING GASKETS NON-CORROSIVE	QUICKSTIX® 534™ HI-TACK GASKET DRESSING	39156	19 g stick	Purple	Vertical, repositionable	Semisolid	N/A	-65°F to 300°F (-54°C to 149°C)	5 minutes to set	Oil resistant	N/A
	GASKET SEALANT 1	30510 30511 30512	1.5 oz. tube 3 oz. tube 7 fl. oz. tube	Reddish-Brown	Fast dry, rigid cure	Paste	75,000/ 110,000	-65°F to 400°F (-54°C to 204°C)	Full strength – 24 hours	Oil resistant	CFIA
	GASKET SEALANT 2	30513 30514 30515 80964	1.5 oz. tube 3 oz. tube 7 fl. oz. tube 5 gallon can	Black	Slow drying, flexible cure	Paste	75,000/ 110,000	-65°F to 400°F (-54°C to 204°C)	Remains tacky	Oil resistant	N/A
	HIGH TEMPERATURE GASKET MAKER	30558	7 fl. oz. tube	Black	High temperature	Paste	75,000/ 110,000	-50°F to 600°F	3 to 5 hours to set	Oil resistant	CFIA
	HI-TACK GASKET SEALANT	30524 30525 30526	0.25 pint brush-top can 1 pint brush-top can 9 oz. net wt. aerosol	Red	Improved heat transfer, repositionable	Liquid	420/650	-65°F to 500°F (-54°C to 260°C) [aerosol to 600°F/316°C]	5 minutes to set	Increased oil resistance	N/A
	AVIATION GASKET SEALANT	30517 30516	0.25 pint brush can 1 pint brush can	Dark Reddish-Brown	Close tolerance, slow cure	Liquid	85/140	-65°F to 400°F (-54°C to 204°C)	Full strength – 12 hours	Oil resistant	CFIA
	COPPER GASKET ADHESIVE	30535	9 oz. net wt. aerosol	Copper	Improved heat transfer, fills surface imperfections	Aerosol	N/A	-50°F to 500°F	Remains tacky	Oil resistant	N/A

Your Source for
GASKETING & SEALING
ANAEROBIC EQUIPMENT



LOCTITE® PRODUCT	ITEM NUMBER	PRESSURE REGULATION	USED TO DISPENSE	PACKAGE TYPE & SIZES	VISCOSITY RANGE	LOW LEVEL SENSING	CONSUMABLES – DISPENSE ACCESSORIES		
PNEUMATIC CARTRIDGE DISPENSING									
DISPENSE SYSTEMS		300 ML PNEUMATIC CARTRIDGE DISPENSING RETAINER	98319A	0 to 60 psi	Gel Cyanoacrylates, Anaerobic Gasketing, Light Cure/Acrylics, Silicones	300 ml cartridges	Low to Medium	Pneumatic	Cartridge Accessories – Page 183
		PNEUMATIC HANDHELD 300 ML DISPENSER	1294304	0 to 100 psi	Gel Cyanoacrylates, Anaerobic Gasketing, Light Cure/Acrylics, Silicones	300 ml cartridges 250 ml tubes	Medium to High	No	
		300 ML CARTRIDGE PUSHER	98022	0 to 50 psi	Gel Cyanoacrylates, Anaerobic Gasketing, Light Cure/Acrylics, Low Viscosity Silicones	300 ml cartridges 250 ml tubes	Medium	Yes	

LOCTITE® PRODUCT	ITEM NUMBER	DISPENSE PATTERNS	USED TO DISPENSE	PACKAGE TYPE & SIZES	VISCOSITY RANGE	CONSUMABLES – DISPENSE ACCESSORIES		
ANAEROBIC GASKETING DELIVERY SYSTEMS								
DISPENSE SYSTEMS		PUMP-A-BEAD™ II DISPENSER	986000	Bead	Anaerobic Gasketing	850 ml cartridges	Medium to High	For Spare Parts and Accessories, visit www.equipment.loctite.com

LOCTITE® PRODUCT	ITEM NUMBER	TYPE	VISCOSITY RANGE	DISPENSE PATTERNS	USED TO DISPENSE	STROKE ADJUSTMENT	SUCK-BACK	CONSUMABLES – DISPENSE ACCESSORIES		
HIGH VISCOSITY FLUID AND PASTE VALVES										
VALVES & PUMPS		POPPET VALVE	986300	High Viscosity Fluid and Paste	Medium to High	Anaerobic Gasketing	Drop, Bead	Yes	Yes	Dispense Tips and Accessories – Page 182-186

Your Source for
GASKETING & SEALING
ELASTOMERIC
ADHESIVES & SEALANTS

- Products with “Flextec® Technology” are based on Henkel’s proprietary polymer backbone
- Exhibit high resiliency while maintaining high tensile strength and good adhesion to many substrates – all without the use of a primer
- Isocyanate and solvent-free, noncorrosive, and compatible with most paint systems
- Begin to cure into a strong thermoset polymer when in contact with ambient moisture
- Ideal for bonding and sealing a multitude of substrates, as well as many applications where silicones cannot be used due to their incompatibility with paint systems



Source's PICK

Loctite® 5510™ Adhesive/Sealant

BLACK, GREY AND WHITE

A multipurpose product based on Flextec® Technology suitable for many adhesive and sealant applications. It offers a fast skin time and cures to a tack-free surface. Its outstanding adhesion and toughness make it ideal for bonding and sealing between dissimilar substrates that are subjected to joint movement or impact.

Item #	1073344	300 ml cartridge	White
	1194277	50 lb. pail	White
	1073346	300 ml cartridge	Grey
	1194276	50 lb. pail	Grey
	1073347	300 ml cartridge	Black
	1197374	50 lb. pail	Black

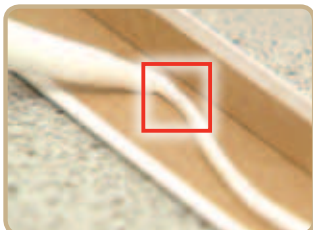
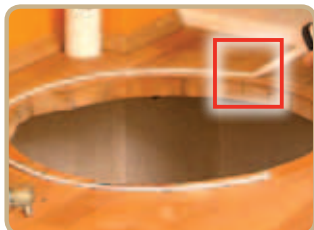

Loctite® 5512™ Adhesive Sealant

High elongation and tensile strength give this product the best of both worlds. This product has good adhesion to many substrates, as well as good impact and peel resistance.

Item #	41380	300 ml cartridge
	41387	5 gallon pail

Source's PICK

Loctite® 5570™ Adhesive

CLEAR AND WHITE

A strong bonding adhesive based on Flextec® Technology with elastic properties for bonding dissimilar substrates. High initial tack and fast setting make it ideal for high productivity applications.

Item #	1073348	300 ml cartridge	White
	1197375	50 lb. pail	White
	1073349	300 ml cartridge	Clear
	1197372	40 lb. pail	Clear

Loctite® 5572™ Adhesive

This product exhibits the highest shear strength on a majority of substrates compared to the other products in this line.

Item #	41379	300 ml cartridge
	41386	5 gallon pail

Loctite® 5590™ Adhesive

A two-component adhesive for elastic bonding where the curing rate of one-component adhesives is too slow. The mixed adhesive is non-sag, has high tack and fast set time. The cured product provides durable bonding to a wide variety of substrates.

Item #	1091896	400 ml dual cartridge
--------	---------	-----------------------



FLEXTEC® TECHNOLOGY

Flextec® Technology indicates the use of Henkel’s proprietary polymers to formulate outstanding handling and performance into adhesives and sealants. These non-silicone polymers are designed for primerless adhesion, speed and durability in all elastomeric applications.



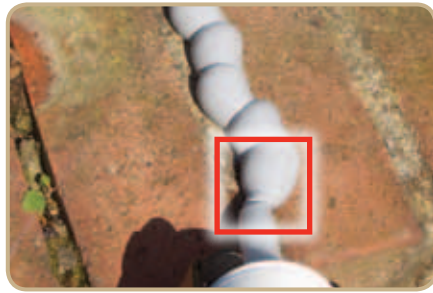
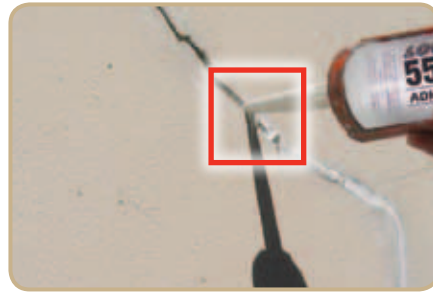

- [Applications]**
- General Assembly
 - Seal Expansion Joints
 - Seal Precast Panels
 - Seal Air or Water Penetration Joints
 - Bond Trim and Molding
 - Bond Roof or Side Panels to Tubular Frames
 - Seal Doors, Windows and Skylights
- [Industries]**
- Seal Wall Penetrations
 - Bond Flooring to Sub-Floor or Metal Frames
 - Seal Siding, Roofing and Gutters
 - Appliances
 - HVAC
 - Signage/Displays
- General Maintenance
 - Specialty Vehicles
 - Agricultural Vehicles
 - Trailers and Buses
 - Recreational Vehicles
 - Manufactured Housing
 - Metallic or Wooden Construction
- APPLICATIONS & INDUSTRIES**

[Loctite® Elastomeric Adhesives & Sealants Properties Chart]

LOCTITE® PRODUCT	ITEM NUMBER	PACKAGE TYPE/SIZE	COLOR	EXTRUSION RATE** (G MIN.)	CURE METHOD	SKIN TIME (MIN.)	TEMPERATURE RANGE	HARDNESS SHORE A	TENSILE STRENGTH* (psi)	ELONGATION AT BREAK (%)	SHEAR STRENGTH ON STEEL (psi)	
ELASTOMERIC ADHESIVES	5510™	1073344 50 lb. pail	White	200	Moisture	30	-40°F (-40°C) to 200°F (93°C)	40	250	300	250	
		1073346 50 lb. pail	Grey									
		1073347 50 lb. pail	Black									
	5512™	41380 41387	300 ml cartridge 5 gallon pail	Black	90	Moisture	5	-40°F (-40°C) to 200°F (93°C)	55	390	500	270
	5570™	1073348 1197375	300 ml cartridge 50 lb. pail	White	150	Moisture	30	-40°F (-40°C) to 200°F (93°C)	55	380	230	400
		1073349 1197372	300 ml cartridge 40 lb. pail	Clear	110		20		45	250	140	280
	5572™	41379 41386	300 ml cartridge 5 gallon pail	Black	90	Moisture	12	-40°F (-40°C) to 200°F (93°C)	55	475	225	425
5590™	1091896	400 ml dual cartridge	Black	N/A	Two-Component Static Mix	25	-40°F (-40°C) to 200°F (93°C)	60	435	130	290	
5590™ PART A	1091892	5 gallon pail	Black									
5590™ PART B	1091893	5 gallon pail	Black									

ITEMS IN RED = Source's PICK or NEW * Grit-blasted steel. ** Extrusion rate at 73°F, 3.5 mm diameter, 3 bar, for 15 seconds.

Your Source for GASKETING & SEALING **ELASTOMERIC EQUIPMENT**

LOCTITE® PRODUCT	ITEM NUMBER	PRESSURE REGULATION	USED TO DISPENSE	PACKAGE TYPE & SIZES	VISCOSITY RANGE	LOW LEVEL SENSING	CONSUMABLES – DISPENSE ACCESSORIES	
PNEUMATIC CARTRIDGE DISPENSING								
DISPENSE SYSTEMS		1046901	0 to 725 psi	Silicone, Polyurethane, MS Polymer Adhesives	300 ml cartridges	10,000 to 1,000,000 cP	Yes	Use with High Pressure Dispense Valve (sold separately) – see below
		1294304	0 to 100 psi	Gel Cyanoacrylates, Anaerobic Gasketing, Light Cure/Acrylics, Silicones	300 ml cartridges 250 ml tubes	Medium to High	No	Cartridge Accessories – Page 183

LOCTITE® PRODUCT	ITEM NUMBER	TYPE	VISCOSITY RANGE	DISPENSE PATTERNS	USED TO DISPENSE	STROKE ADJUSTMENT	SUCK-BACK	CONSUMABLES – DISPENSE ACCESSORIES	
HIGH VISCOSITY FLUID & PASTE VALVES									
VALVES & PUMPS		1049138	High Viscosity Fluid and Paste Valves	10,000 to 1,000,000 cP	Drop, Bead	Silicones, MS Polymers, Urethanes	Yes	Yes	Dispense Tips and Accessories – Pages 182-186
		1153502	High Viscosity Fluid and Paste Valves	500,000 to 2,000,000 cP	Drop, Bead	Silicones, MS Polymers, Urethanes	Yes	No	Dispense Tips and Accessories – Pages 182-186

Your Source for
GASKETING & SEALING
**SILICONE
ADHESIVES & SEALANTS**

- Excellent fluid resistance
- Formulations for high operating temperatures available
- UV-curing formulations for cure-in-place production requirements
- Suited best for large gap applications and stamped metal assemblies where flange flexing occurs

[Formed-In-Place]

Loctite® 5605™/5606™/5607™ Silicone Adhesive/Sealants

TWO-PART, NONCORROSIVE

Designed for strong elastic bonding and sealing applications. Products vary in fixture and open times to match particular end-use applications. Easy to dispense. Grey in color.

Item #	5605™	1250155	400 ml dual cartridge
	5605™ – Part B	1251677	3.5 gallon pail
	5605™ – Part B	1250758	575 lb. drum
	5606™	1250154	400 ml dual cartridge
	5606™ – Part B	1250755	3.5 gallon pail
	5606™ – Part B	1250156	575 lb. drum
	5607™	1252929	400 ml dual cartridge
	5607™ – Part B	1250756	3.5 gallon pail
	5607™ – Part B	1250757	575 lb. drum
	5600™ Series – Part A	1253201 [†]	4.5 gallon pail
	5600™ Series – Part A	1253202 ^{††}	440 lb. drum

Loctite® 5613™ Silicone

TWO-PART, OIL-RESISTANT SILICONE

Designed for superior fluid resistance. Fast room temperature cure. Black in color.

Item #	1253211	400 ml dual cartridge
Part A	1253208	4.5 gallon pail
Part B	1253206	3.5 gallon pail
Part A	1253207	440 lb. drum
Part B	1253212	575 lb. drum

Loctite® 5620™ Silicone

TWO-PART, ULTRA-CLEAR, FAST CURE SILICONE

Transparent in color. Ideal for adhesive, sealant or potting applications that require a transparent silicone. Fast room temperature cure.

Item #	1257593	50 ml dual cartridge
	1257478	400 ml dual cartridge
Part A	1257595	40 lb. pail
Part B	1257597	40 lb. pail
Part A	1257594	400 lb. drum
Part B	1257596	400 lb. drum

Loctite® 5045™ Flange Sealant NONCORROSIVE, ALKOXY SILICONE

RTV paste; excellent for adhesion, sealing and gasketing applications.

Item #	40409	3 oz. tube
	40408	300 ml cartridge
	40724	40 lb. pail

Loctite® 5600™ Silicone Sealant TWO-PART, NONCORROSIVE

Fast, 5-minute fixture, high adhesion, flexible adhesive/sealant. Available in Black, Grey and Almond.

Item #	Black – Part A	41327	440 lb. drum
	Black – Part B	41732	575 lb. drum
	Black – Part A	922122	4.5 gallon pail
	Black – Part B	922089	3.5 gallon pail
	Black	922546	400 ml dual cartridge
	Grey – Part A	922129	440 lb. drum
	Grey – Part B	41732	575 lb. drum
	Grey – Part A	922128	4.5 gallon pail
	Grey – Part B	922089	3.5 gallon pail
	Grey	922544	400 ml dual cartridge
	Almond – Part A	924107	4.5 gallon pail
	Almond – Part B	922089	3.5 gallon pail

Loctite® 5604™ Silicone Sealant

TWO-PART, NONCORROSIVE

Fast, 10-minute fixture, excellent bonding product. Available in Black, Grey and Almond.

Item #	Black	1138258	400 ml dual cartridge
	Black – Part A	41327	440 lb. drum
	Gray – Part A	922129	440 lb. drum
	Almond – Part A	924107	4.5 gallon pail
	5604 – Part B	1112888	575 lb. drum

Loctite® 5699™ Grey, High Performance RTV Silicone Gasket Maker

For rigid flange assemblies. Excellent fluid resistance. Easy to dispense, noncorrosive, low odor, low volatility. Grey in color.

Item #	18718	70 ml tube
	18581	300 ml cartridge
	18582	50 lb. pail
	18583	550 lb. drum
	40505	190 ml can

Loctite® 5900® Flange Sealant HEAVY BODY RTV SILICONE

Superior flexibility and adhesion. Provides instant seal. Excellent fluid resistance. Noncorrosive, low odor, low volatility. Black in color.

Item #	20166	300 ml cartridge
	20167	50 lb. pail
	20168	550 lb. drum

Loctite® 5905™ Flange Sealant RTV Silicone

Superior flexibility and adhesion; fast cure depth. Offers excellent fluid resistance. Now available in black and white.

Item #	Black	38535	300 ml cartridge
	Black	36923	50 lb. pail
	White	40969	300 ml cartridge

Loctite® 5910® Flange Sealant RTV Silicone

Superior flexibility and adhesion. Excellent fluid resistance. Medium body and easy to dispense. Noncorrosive, low odor, low volatility. Black in color.

Item #	21746	300 ml cartridge
	21747	50 lb. pail
	21748	550 lb. drum

[†] 5600™ Series – Part A (1253201) can be used with 5605™, 5606™, 5607™ – Part B (3.5 gallon pail).

^{††} 5600™ Series – Part A (1253202) can be used with 5605™, 5606™, 5607™ – Part B (575 lb. drum).

Sources REVEALED

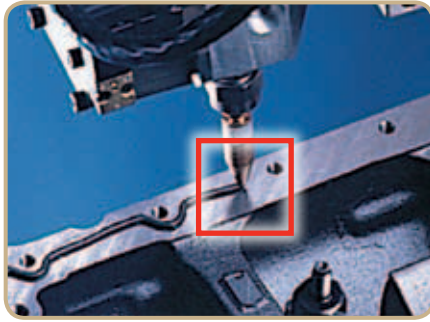

[Industries / Applications]

- Agriculture Equipment
- Appliance
- Assembly
- Construction

- Electrical
- Electronics
- Engine Gasketing
- Food and Beverage
- Lighting
- Maintenance, Repair or Overhaul

- Power Generation
- Pumps
- Solar
- Specialty Vehicle
- Wastewater
- Windows

APPLICATIONS & INDUSTRIES

Loctite® 5920™ Copper, High Performance RTV Silicone Gasket Maker

High performance for rigid flange assemblies. Low volatility. Copper in color.

Item #	30542	70 ml tube
	82046	300 ml cartridge
	21472	40 lb. pail

Loctite® 5999™ Flange Sealant

HEAVY BODY/GREY, HIGH PERFORMANCE RTV SILICONE GASKET MAKER

For rigid flange assemblies. Provides instant seal. Excellent fluid resistance. Noncorrosive, low odor, low volatility. Grey in color.

Item #	21744	300 ml cartridge
	28298	50 lb. pail
	20170	550 lb. drum

Loctite® 5970™ Alcoxy Gasket Maker

A non-oxime gasket maker. Excellent oil resistance.

Item #	39246	300 ml cartridge
	35230	50 lb. pail
	35229	550 lb. drum

[Cured-in-Place]

Loctite® 5050™ Fastgasket®

A UV light curing silicone for high speed adhesion, gasketing and sealing applications. High adhesion for difficult-to-bond substrates.

Item #	1212166	300 ml cartridge
	1212165	40 lb. pail

Loctite® 5039™ Nuva-Sil® Silicone Adhesive Sealant

Designed for automated assembly. Rapid, 30-second, UV or visible light cure permits in-line processing. Secondary moisture cure ensures full cure even in shadowed areas. Translucent in color.

Item #	40438	300 ml cartridge
	40439	40 lb. pail

Loctite® 5950™ Fastgasket® Flange Sealants

Designed for automated assembly. Rapid, 30-second, UV cure permits in-line processing. Secondary moisture cure ensures full cure even in shadowed areas. Black/clear in color.

Item #	29287	5950™	300 ml cartridge
	18495	5950™	40 lb. pail

Loctite® 5963™ Procure® Cure-in-Place Gasket

HEAT CURE COMPRESSION

Superior compression set resistance. One-component, exceptional fluid resistance and heat resistance to 302°F (150°C). Great for power train applications. Grey in color.

Item #	34337	50 lb. pail
--------	-------	-------------

Loctite® 5964™ Procure® Cure-in-Place Gasket

HEAT CURE COMPRESSION

Soft, with greater elongation. Cures with either convection heat or microwave. One-component, good compression set for power train applications. Brown in color.

Item #	34347	50 lb. pail
--------	-------	-------------

[High Performance RTV Silicones]

Loctite® Instant Gasket

Makes high performance, leakproof gaskets in one minute. Equipment can be returned to service immediately. Blowout resistant. Outperforms pre-cut gaskets.

Item #	30509	5 oz. cartridge
	40479	190 ml can
	40478	90 ml can

Loctite® 598™ Black, High Performance RTV Silicone Gasket Maker

Retains high flexibility and oil resistance for longer gasket life. Temperature range is -75°F to 625°F (-59°C to 329°C) intermittent. Low odor, noncorrosive, low volatility. Resistant to most chemicals and solvents. Fills gaps to 0.25 in.

Item #	34018	0.5 oz. tube*
	59830	70 ml tube
	59875	300 ml cartridge
	59891	49 lb. pail
	40463	190 ml can

Loctite® 587™ Blue, High Performance RTV Silicone Gasket Maker

Forms tough, flexible gaskets directly on the flange. Offers excellent adhesion to oily surfaces. Low odor, non-corrosive, low volatility. Withstands temperatures to 500°F (260°C) intermittent. Resistant to most chemicals and solvents. Fills gaps to 0.25 in.

Item #	58730	70 ml tube
	58775	300 ml cartridge
	58791	17 liter pail
	40462	190 ml can

* Uncarded tubes, sold as full cases of 100 pieces.

**Your Source for
GASKETING & SEALING
SILICONE
ADHESIVES & SEALANTS**

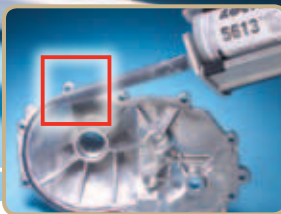

[Superflex® RTV Silicones]

Loctite® Superflex® RTV Silicone Adhesive Sealant – Blue, Equipment Green, Construction Yellow

Cures to a tough, flexible rubber. Makes reliable “formed-in-place” gaskets that resist shrinking, cracking and migrating. Coats pre-cut gaskets to increase reliability. Temperature range is -65°F to 500°F (-54°C to 260°C) intermittent. Low volatility. Fills gaps to 0.25 in.

Item #	30560	Blue RTV	80 ml tube
	30533	Blue RTV	300 ml cartridge
	30518	Blue RTV	12 oz. tube
	40482	Blue RTV	190 ml can
	1165866	Equipment Green RTV	190 ml can
	1165867	Construction Yellow RTV	190 ml can

Loctite® Superflex® Red High Temp RTV Silicone Adhesive Sealant

Makes gaskets that resist temperatures to 600°F (315°C) intermittent. Resists aging, weather and thermal cycling without shrinking, cracking or hardening. Fills gaps to 0.25 in.

Item #	59630	80 ml tube
	59675	300 ml cartridge
	82279	12 oz. tube
	40465	190 ml can

Loctite® Superflex® Non-corrosive RTV, Clear Silicone Adhesive Sealant

Neutral curing and noncorrosive. For aluminum, concrete and electrical applications. Temperature resistant to 400°F (204°C) continuous service, 500°F (260°C) intermittent.

Item #	51387	80 ml tube
	51388	300 ml cartridge

Loctite® Superflex® RTV Silicone Adhesive Sealant

General-purpose, one-part silicone adhesive sealant cures at room temperature to form a tough rubber seal. Will not slump in overhead or vertical applications. Formulated to withstand extreme temperature cycling, UV light and ozone. Cannot be painted. Available in Black, Clear and White.

Item #	59330	80 ml tube	Black
	59375	300 ml cartridge	Black
	40464	190 ml can	Black
	1266142	0.5 oz. tube*	Clear
	59530	80 ml tube	Clear
	59575	300 ml cartridge	Clear
	40481	190 ml can	Clear
	59430	80 ml tube	White
	59475	300 ml cartridge	White
	40466	190 ml can	White

Loctite® Tile Bond Red, High Temp RTV Silicone Adhesive Sealant

High initial tack strength silicone that resists temperatures to 600°F (315°C) intermittent.

Item #	19163	300 ml cartridge
	1162399	4.5 gallon pail

Loctite® SpeedSeal™ Silicone Sealant

MOLD- AND MILDEW-RESISTANT, FAST WATERPROOF SEAL

Creates a tough, watertight, mildew-resistant seal on a wide range of substrates, including ceramics, porcelain, glass, fiberglass composites, enamel, aluminum, stainless steel, wood and wallboard. Withstands water contact just two hours after application.

Item #	1311327	300 ml cartridge	Clear
	1312042	300 ml cartridge	White

[Urethane Sealant]

Loctite® Urethane Sealant

Single-component, gun-grade caulk that bonds, seals and waterproofs up to 180°F (82°C). Outstanding adhesion properties to concrete, masonry, glass, plastics, wood, aluminum and most other metals.

Item #	39916	10.2 oz. cartridge	Grey
--------	-------	--------------------	------

[Polyacrylate Sealant]

Loctite® 5810A

Single-component, non-silicone polyacrylate based adhesive/sealant. Excellent oil resistance.

Item #	39211	300 ml. cartridge
	39210	50 lb. pail

[Loctite® Silicones & Urethane Gasketing Attributes & Application Chart]

LOCTITE® PRODUCT	MAIN ATTRIBUTES	APPLICATIONS
INSTANT GASKET	Instant seal and blowout resistance, replaces most cut gaskets, low odor, sensor-safe	Timing gear and valve covers, water pumps, gearboxes, transmission pans
598™ BLACK	Forms a tough, flexible silicone rubber gasket	Oil pans, valve covers, timing gear covers, differential covers
587™ BLUE	Plant maintenance and small-to-large-sized OEMs	Typical automotive gasketing applications
5699™ GREY	Excellent oil resistance	Rigid flange sealing of transmissions and cast metal housings
5920™ COPPER	Fills voids in surfaces for a positive seal	Adheres to most surfaces
5905™ BLACK	Fast cure, excellent fluid resistance	Large gap applications, flange flexing
SUPERFLEX® BLUE RTV	Forms a tough, flexible silicone rubber gasket, oxygen sensor-safe	Typical automotive gasketing applications
SUPERFLEX® RED HIGH TEMP RTV	Plant maintenance and small-to-large-sized OEMs low silicone volatiles	Automotive gasketing, industrial furnaces, boilers, ducting
SUPERFLEX® NONCORROSIVE RTV, CLEAR	Resists steam, chemical and UV ozone exposure	Adheres to most surfaces
SUPERFLEX® RTV	Resists aging, weathering and thermal cycling without hardening, shrinking, or cracking	Adheres to most surfaces
SPEEDSEAL™ RTV	Mildew-resistant, forms fast watertight seal	Sealing around water or outdoor applications
URETHANE SEALANT	Lifelong flexibility, paintable, weather-resistant	Forming expansion joints, sealing gutters, filling concrete cracks

* Uncarded tubes, sold as full cases of 100 pieces.

[Loctite® Silicones & Urethane Gasketing Properties Chart]

	LOCTITE® PRODUCT	ITEM NUMBER	PACKAGE TYPE/SIZE	COLOR	CONSISTENCY	OIL RESISTANCE	TEMPERATURE RANGE (INTERMITTENT)	SEALING TIME	AGENCY APPROVALS
SEALING / DRESSINGS FOR EXISTING GASKETS NONCORROSIVE	INSTANT GASKET	30509 40479 40478	5 oz. cartridge 190 ml can 90 ml can	Black	Paste	Increased oil resistance	-75°F to 500°F (-59°C to 260°C)	Operating strength 15 psi – 1 min.	CFIA
	598™ BLACK	34018 59830 59875 59891 40463	0.5 oz. tube* 70 ml tube 300 ml cartridge 49 lb. pail 190 ml can	Black	Paste	Excellent oil resistance	-75°F to 625°F (-59°C to 329°C)	Tack Free – 30 min. Full Strength – 24 hrs.	ABS, CFIA
	587™ BLUE	58730 58775 58791 40462	70 ml tube 300 ml cartridge 50 lb. pail 190 ml can	Blue	Paste	Increased oil resistance	-75°F to 500°F (-59°C to 260°C)	Tack Free – 30 min. Full Strength – 24 hrs.	UL Listed for U.S., NSF® P1, CFIA, ABS
	5699™ GREY	18718 18581 40505	70 ml tube 300 ml cartridge 190 ml can	Grey	Paste	Increased oil resistance	-75°F to 625°F (-59°C to 329°C)	Tack Free – 30 min. Full Strength – 24 hrs.	CFIA
	5920™ COPPER	30542 82046	70 ml tube 300 ml cartridge	Copper	Paste	Increased oil resistance	-65°F to 700°F (-54°C to 371°C)	Tack Free – 60 min. Full Strength – 24 hrs.	CFIA
	5905™ BLACK	38535	300 ml cartridge	Black	Paste	Excellent oil resistance	-65°F to 500°F (-54°C to 260°C)	Tack Free – 20 min. Full Strength – 24 hrs.	CFIA
	SPEEDSEAL™ SILICONE SEALANT	1311327 1312042	300 ml cartridge 300 ml cartridge	Clear White	Paste	N/A	-40°F to 250°F (-40°C to 121°C)	Watertight – 2 hrs.	ISO® 846
SUPERFLEX® RTV SILICONES	SUPERFLEX® RTV – BLUE, EQUIPMENT GREEN & CONSTRUCTION YELLOW	30560 30533 30518 40482 1165866 1165867	80 ml tube 300 ml cartridge 12 oz. tube 190 ml can 190 ml can 190 ml can	Blue Blue Blue Blue Equipment Green Construction Yellow	Paste	N/A	-65°F to 500°F (-54°C to 260°C)	Tack Free – 30 min. Full Strength – 24 hrs.	N/A
	SUPERFLEX® RED HIGH TEMP RTV	59630 59675 82279 40465	80 ml tube 300 ml cartridge 12 oz. tube 190 ml can	Red	Paste	N/A	-75°F to 600°F (-59°C to 316°C)	Tack Free – 30 min. Full Strength – 24 hrs.	CFIA
	SUPERFLEX® RTV	59330 59375 40464	80 ml tube 300 ml cartridge 190 ml can	Black	Paste	N/A	-65°F to 450°F (-54°C to 232°C)	Tack Free – 30 min. Full Strength – 24 hrs.	N/A
		1266142 59530 59575 40481	0.5 oz. tube* 80 ml tube 300 ml cartridge 190 ml can	Clear					UL Listed for U.S., NSF®/ANSI 51, CFIA
59430 59475 40466		80 ml tube 300 ml cartridge 190 ml can	White	N/A					
NONCORROSIVE	SUPERFLEX® NON-CORROSIVE RTV, CLEAR	51387 51388	80 ml tube 300 ml cartridge	Clear	Paste	Oil resistant	-75°F to 500°F (-59°C to 260°C)	Tack Free – 25 min. Full Strength – 24 hrs.	UL Listed for U.S.
URETHANE SEALANT	URETHANE SEALANT	39916	10.2 oz. cartridge	Grey	Paste	N/A	-40°F to 180°F (-40°C to 82°C)	Heavy Skin over 2 to 4 hrs. Full Cure – 3 days	CFIA
HIGH TEMPERATURE	TILE BOND RED HIGH TEMP RTV	19163 1162399	300 ml cartridge 4.5 gallon pail	Red	Paste	N/A	Up to 600°F (315°C)	Tack Free – 30 min. Full Strength – 24 hrs.	N/A
POLYACRYLATE SEALANT	5810A	39211 39210	300 ml. cartridge 50 lb. pail	Black	Paste	Excellent oil resistance	-40°F to 300°F (-40°C to 150°C)	Tack Free – 190 min.	N/A

ITEMS IN RED = Source's PICK or NEW

* Uncarded tubes, sold as full cases of 100 pieces.

**Your Source for
GASKETING & SEALING
SILICONE
ADHESIVES & SEALANTS**

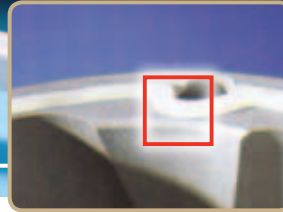

[**Loctite® Formed-In-Place Silicone Gasketing Properties Chart**]

LOCTITE® PRODUCT	ITEM NUMBER	PACKAGE TYPE/SIZE	COLOR/MIX RATIO	TYPICAL USE	GAP FILL	EXTRUSION RATE (g/min.)	TEMP. RANGE	CURE METHOD	CURE SPEED*	SPECIFIC GRAVITY	DUROMETER[‡]	% ELONGATION	TENSILE STRENGTH (psi)	STATIC MIXER	AGENCY APPROVALS												
5045™	40409	3 oz. tube	Clear/	Military, high tensile	0.250 in.	40	-65°F to 400°F (-54°C) to (204°C)	Moisture	Tack Free – 1.5 hrs. Full Cure – 24 hrs.	1.14	25	>500	>493	N/A	MIL-A-46146B												
	40408	300 ml cartridge	N/A																								
	40724	40 lb. pail																									
5600™	Part A - 41327	440 lb. drum	Black/2:1 A:B by volume	High adhesion, fast fixture	Unlimited	N/A	-40°F to 450°F (-40°C) to (232°C)	Two-part	Tack Free – 10 min.	1.40	A 40	200	250	98667	UL Listed for U.S.												
	Part B - 41732	575 lb. drum																									
	Part A - 922122	4.5 gallon pail																									
	Part B - 922089	3.5 gallon pail																									
	922546	400 ml dual cartridge																									
	Part A - 922129	440 lb. drum	Grey/2:1 A:B by volume													High adhesion, fast fixture	Unlimited	N/A	-40°F to 450°F (-40°C) to (232°C)	Two-part	Tack Free – 10 min.	1.40	A 40	200	250	98667	UL Listed for U.S.
Part B - 41732	575 lb. drum																										
Part A - 922128	4.5 gallon pail																										
Part B - 922089	3.5 gallon pail																										
922544	400 ml dual cartridge																										
Part A - 924107	4.5 gallon pail	Almond/2:1 A:B by volume	High adhesion, fast fixture	Unlimited	N/A	-40°F to 450°F (-40°C) to (232°C)	Two-part	Tack Free – 10 min.	1.40	A 40	200	250	98667	UL Listed for U.S.													
Part B - 922089	3.5 gallon pail																										
5604™	Part A - 41327	440 lb. drum													Black/4:1 A:B by volume	High adhesion, fast fixture	Unlimited	N/A	-40°F to 450°F (-40°C) to (232°C)	Two-part	Tack Free – 10 min.	1.40	40	200	250	98667	UL Listed for U.S.
	Part B - 1112888	575 lb. drum																									
	1138258	400 ml dual cartridge																									
	Part A - 922129	440 lb. drum													Grey/4:1 A:B by volume												
Part B - 1112888	575 lb. drum																										
Part A - 924107	4.5 gal. pail	Almond/4:1 A:B by volume	High adhesion, fast fixture	Unlimited	N/A	-40°F to 450°F (-40°C) to (232°C)	Two-part	Tack Free – 10 min.	1.40	40	200	250	98667	N/A													
Part B - 1112888	575 lb. drum																										
5605™	1250155	400 ml dual cartridge													Grey/4:1 A:B by volume	General-purpose, high adhesion, fast fixture, noncorrosive, easy gunning	Unlimited	N/A	-40°F to 450°F (-40°C) to (232°C)	Two-part	Tack Free – 10 min.	1.375	A 40	240	270	98667	N/A
	Part A - 1253201 [‡]	4.5 gallon pail																									
	Part B - 1251677	3.5 gallon pail																									
5606™	Part A - 1253202 [‡]	440 lb. drum	Grey/4:1 A:B by volume	General-purpose, high adhesion, fast fixture, noncorrosive, easy gunning	Unlimited	N/A	-40°F to 450°F (-40°C) to (232°C)	Two-part	Tack Free – 15 min.	1.375	A 38	170	260	98667	UL 94 HB												
	Part B - 1250758	575 lb. drum																									
	Part A - 1253201 [‡]	4.5 gallon pail																									
5607™	Part B - 1250755	3.5 gallon pail	Grey/2:1 A:B by volume	General-purpose, high adhesion, fast fixture, noncorrosive, easy gunning	Unlimited	N/A	-40°F to 450°F (-40°C) to (232°C)	Two-part	Tack Free – 45 min.	1.425	A 43	150	225	98667	N/A												
	Part A - 1253202 [‡]	440 lb. drum																									
	Part B - 1250156	575 lb. drum																									
5607™	1252929	400 ml dual cartridge	Grey/2:1 A:B by volume	General-purpose, high adhesion, fast fixture, noncorrosive, easy gunning	Unlimited	N/A	-40°F to 450°F (-40°C) to (232°C)	Two-part	Tack Free – 45 min.	1.425	A 43	150	225	98667	N/A												
	Part A - 1253201 [‡]	4.5 gallon pail																									
	Part B - 1250756	3.5 gallon pail																									
5613™	Part A - 1253202 [‡]	440 lb. drum	Black/2:1 A:B by volume	Oil resistant, high adhesion, fast fixture, noncorrosive, easy gunning	Unlimited	N/A	-40°F to 450°F (-40°C) to (232°C)	Two-part	Tack Free – 10 min.	1.425	A 47	155	220	98667	N/A												
	Part B - 1250757	575 lb. drum																									
	Part A - 1253211	400 ml dual cartridge																									
5613™	Part A - 1253208	4.5 gallon pail	Black/2:1 A:B by volume	Oil resistant, high adhesion, fast fixture, noncorrosive, easy gunning	Unlimited	N/A	-40°F to 450°F (-40°C) to (232°C)	Two-part	Tack Free – 10 min.	1.425	A 47	155	220	98667	N/A												
	Part B - 1253206	3.5 gallon pail																									
	Part A - 1253212	440 lb. drum																									
5613™	Part B - 1253217	575 lb. drum	Black/2:1 A:B by volume	Oil resistant, high adhesion, fast fixture, noncorrosive, easy gunning	Unlimited	N/A	-40°F to 450°F (-40°C) to (232°C)	Two-part	Tack Free – 10 min.	1.425	A 47	155	220	98667	N/A												
	Part A - 1253208	4.5 gallon pail																									
	Part B - 1253206	3.5 gallon pail																									

ITEMS IN RED = Source's PICK or NEW

🌐 = Indicates Worldwide Availability

* Varies with substrates † Shore A ‡ Grit-blasted steel
[‡] 5600™ Series – Part A (1253201) can be used with 5605™, 5606™, 5607™ – Part B (3.5 gallon pail).
[‡] 5600™ Series – Part A (1253202) can be used with 5605™, 5606™, 5607™ – Part B (575 lb. drum).

[More Loctite® Formed-In-Place Silicone Gasketing Properties Chart]

LOCTITE® PRODUCT	ITEM NUMBER	PACKAGE TYPE/SIZE	COLOR/MIX RATIO	TYPICAL USE	GAP FILL (INCHES)	EXTRUSION RATE (g/min.)	TEMP. RANGE	CURE METHOD	CURE SPEED*	SPECIFIC GRAVITY	DUROMETER [‡]	% ELONGATION	TENSILE STRENGTH (psi) ¹	AGENCY APPROVALS
5620™	1257593	50 ml dual cartridge	Ultra-Clear / 1:1 A:B by volume	Ultra-clear potting, encapsulating, and sealing; noncorrosive	Unlimited	N/A	-40°F to 450°F (-40°C to 232°C)	Two-part	30 min.	1.00	A 35	N/A	N/A	N/A
	1257478	400 ml dual cartridge												
	Part A - 1257595 Part B - 1257597	40 lb. pail 40 lb. pail												
	Part A - 1257594 Part B - 1257596	400 lb. drum 400 lb. drum												
5699™ GREY	18718 18581 18582 18583 40505	70 ml tube 300 ml cartridge 50 lb. pail 550 lb. drum 190 ml can	Grey	Oil/water resistant	0.250	250	-75°F to 625°F	Moisture	Tack Free – 30 min. Full Cure – 24 hrs.	1.45	55	160	435	CFIA
5900®	20166 20167 20168	300 ml cartridge 50 lb. pail 550 lb. drum	Black	High adhesion, instant seal	0.250	35	-65°F to 500°F	Moisture	Tack Free – 20 min. Full Cure – 24 hrs.	1.34	35	550	200	CFIA, NSF® P1
5905™	38535 36923	300 ml cartridge 50 lb. pail	Black	High adhesion, fast cure depth	0.240	350	-65°F to 500°F	Moisture	Tack Free – 20 min. Full Cure – 24 hrs.	1.30	39	345	270	CFIA
	40969	300 ml cartridge	White											
5910®	21746 21747 21748	300 ml cartridge 50 lb. pail 550 lb. drum	Black	High adhesion	0.240	600	-65°F to 500°F	Moisture	Tack Free – 20 min. Full Cure – 24 hrs.	1.34	30	550	200	CFIA
5920™ COPPER	30542 82046 21472	70 ml tube 300 ml cartridge 40 lb. pail	Copper	High temperature	0.240	>300	-65°F to 700°F	Moisture	Tack Free – 60 min. Full Cure – 24 hrs.	1.05	31	355	275	CFIA
5970™	39246 35230 35229	300 ml cartridge 50 lb. pail 550 lb. drum	Black	Oil/water resistance	0.240	60	-40°F to 450°F (-40°C) to 232°C	Moisture	Tack Free – 25 min. Full Cure – 24 hrs.	1.41	A 44	>200	278	N/A
5999™	21744 28298 20170	300 ml cartridge 50 lb. pail 550 lb. drum	Grey	Oil/water resistant, instant seal	0.240	105	-75°F to 625°F	Moisture	Tack Free – 10 min. Full Cure – 24 hrs.	1.45	60	175	500	N/A



= Indicates Worldwide Availability

* Varies with substrates

‡ Shore A

¹ Grit-blasted steel

Your Source for
GASKETING & SEALING
SILICONE
ADHESIVES & SEALANTS



[**Loctite® Cured-In-Place Silicone Gasketing Properties Chart**]

LOCTITE® PRODUCT	ITEM NUMBER	PACKAGE TYPE/SIZE	COLOR	EXTRUSION RATE (g/min.)	CURE METHOD	CURE SPEED*	HARDNESS	% ELONGATION	TENSILE STRENGTH (psi)	AGENCY APPROVALS
5039™ NUVA-SIL®	40438 40439	300 ml cartridge 40 lb. pail	Translucent/ Colorless/Fluorescent	222	UV or Visible/ Moisture	30 sec. @ 120 mW/cm²	40	210	290	N/A
5050™ FASTGASKET®	1212166 1212165	300 ml cartridge 40 lb. pail	Translucent	500	Ultraviolet	Ultraviolet	45	260	421	N/A
5950™ FASTGASKET®	29287 18495	300 ml cartridge 40 lb. pail	Black	350	UV/Moisture	30 sec. @ 120 mW/cm²	27	200	150	N/A
5963™ PROCURE®	34337	50 lb. pail	Grey	250	Heat	10 min. @ 150°C	48	360	620	N/A
5964™ PROCURE®	34347	50 lb. pail	Brown	120	Heat/ Microwave	10 min. @ 150°C VFM 2 to 4 min.	28	530	635	N/A
3407™ OPTILOC®	35173	30 ml syringe	Black	5	Heat	60 min. @ 150°C	38	>600	>493	N/A

ITEMS IN RED = Source's PICK or NEW

= Indicates Worldwide Availability

Loctite® Manual Cartridge Applicators

This applicator has a revolving barrel frame that rotates to allow for easy application of materials around corners. The one-piece sintered friction catch plate has extra durability and higher precision when compared to models with two-piece friction catch plate with plastic inserts.

Description:

- High mechanical advantage 26:1 ratio
- 300 ml cartridges
- Medium to high viscosity range



Easy-to-Dispense Aerosol Can Systems for Loctite® Silicones

Several Loctite® silicones are now available in the most advanced system for dispensing silicones. This new package offers effortless fingertip control, easy-to-use (even upside down), and accurate dispensing while eliminating the waste, mess, and caulking guns needed for other silicone dispense systems.

- | | | | |
|--------|---------|--------|-------------------------|
| Item # | 40479 | 190 ml | Instant Gasket |
| | 40478 | 90 ml | Instant Gasket |
| | 40505 | 190 ml | 5699 Grey |
| | 40462 | 190 ml | 587 Blue |
| | 40463 | 190 ml | 598 Black |
| | 40465 | 190 ml | RTV Red |
| | 40481 | 190 ml | RTV Clear |
| | 40466 | 190 ml | RTV White |
| | 40464 | 190 ml | RTV Black |
| | 40482 | 190 ml | RTV Blue |
| | 1165866 | 190 ml | Equipment Green RTV |
| | 1165867 | 190 ml | Construction Yellow RTV |









ADDITIONAL RESOURCES

Your Source for
GASKETING & SEALING
SILICONE ADHESIVES & SEALANTS EQUIPMENT

YOUR EQUIPMENT *Source*

For more details, see the **Loctite® Equipment Sourcebook, LT-3669**, or visit us on the web for additional information, diagrams, products and our full line of equipment at www.equipment.loctite.com.

LOCTITE® PRODUCT		ITEM NUMBER	PRESSURE REGULATION	USED TO DISPENSE	PACKAGE TYPE & SIZES	VISCOSITY RANGE	LOW LEVEL SENSING	CONSUMABLES – DISPENSE ACCESSORIES	
DISPENSE SYSTEMS	PNEUMATIC CARTRIDGE DISPENSING								
		300 ML PNEUMATIC CARTRIDGE DISPENSING RETAINER	98319A	0 to 60 psi	Gel Cyanoacrylates, Anaerobic Gasketing, Light Cure/Acrylics, Silicones	300 ml cartridges	Low to Medium	Pneumatic	Cartridge Accessories – Page 183
		PNEUMATIC HANDHELD 300 ML DISPENSER	1294304	0 to 100 psi	Gel Cyanoacrylates, Anaerobic Gasketing, Light Cure/Acrylics, Silicones	300 ml cartridges 250 ml tubes	Medium to High	No	
		300 ML CARTRIDGE PUSHER	98022	0 to 50 psi	Gel Cyanoacrylates, Anaerobic Gasketing, Light Cure/Acrylics, Low Viscosity Silicones	300 ml cartridges 250 ml tubes	Medium	Yes	
	HIGH PRESSURE 300 ML BENCHTOP CARTRIDGE DISPENSER	1046901	0 to 725 psi	Silicone, Polyurethane, MS Polymer Adhesives	300 ml cartridges	10,000 to 1,000,000	Yes	Use with High Pressure Dispense Valve (sold separately) – see below	

LOCTITE® PRODUCT		ITEM NUMBER	TYPE	VISCOSITY RANGE	DISPENSE PATTERNS	USED TO DISPENSE	STROKE ADJUSTMENT	SUCK-BACK	CONSUMABLES – DISPENSE ACCESSORIES
VALVES & PUMPS	HIGH VISCOSITY FLUID & PASTE VALVES								
		HIGH PRESSURE DISPENSE VALVE – 50 BAR	1049138	High Viscosity Fluid and Paste Valves	10,000 - 1,000,000 cP	Drop, Bead	Silicones, MS Polymers, Urethanes	Yes	Yes
	HIGH PRESSURE DISPENSE VALVE – 150 BAR	1153502	500,000 - 2,000,000 cP		Yes			No	

ITEMS IN RED = Source's PICK or NEW

LOCTITE® BRANDED EQUIPMENT – Loctite® is a full service supplier of equipment and offers a wide variety of equipment services to its customers. **For more Loctite® branded equipment, go to page 171.**
 Can't find what you're looking for? Visit www.equipment.loctite.com or call 1-800-LOCTITE (562-8483).

STRAIGHT FROM *The Source*

Your Source for
GASKETING & SEALING
WINDSHIELD GLASS
INSTALLATION (DGX)

Terostat® branded products have been used in leading edge direct glazing (DGX) application solutions for more than 20 years. DGX is the bonding and sealing of front windshields, side and rear glass to vehicle assemblies. Our DGX products are sag-resistant with high elasticity, high tensile strength and fast curing rates. The Terostat® DGX line include adhesives/sealants that are polyurethane and modified silane polymer, which is free of isocyanates and has high UV resistance. All adhesive/sealants in the line have been tested and approved in strict accordance to the U.S. Federal Motor Vehicle Safety Standard (FMVSS 208).



Cold Applied – No Heat Required

Short Cycle Time / Fast Return to Service Required

PRIMERLESS APPLICATION

ISOCYANATE-FREE

Terostat® 9000 PL HMLC Direct Glazing Adhesive

Item # 1370891 310 ml cartridge
 1430053 25 kg pail

Terostat® 9096 PL Direct Glazing Adhesive

Item # 1377641 310 ml cartridge

Terostat® 8597 HMLC Direct Glazing Adhesive

Item # 1377642 310 ml cartridge

Terostat® 8599 Direct Glazing Adhesive

Item # 1377643 310 ml cartridge
 1371250 25 kg pail
 1377390 245 kg drum

[Direct Glazing Adhesive]

Source's PICK Terostat® 9000 PL HMLC Direct Glazing Adhesive

MODIFIED SILANE (MS) POLYMER ADHESIVE/SEALANT

An isocyanate-free primerless cold applied, high modulus, low conductivity product. FMVSS 208 2-hour drive away time.

Item # 1370891 310 ml cartridge
 1430053 25 kg pail

Source's PICK Terostat® 9096 PL Direct Glazing Adhesive

POLYURETHANE ADHESIVE/SEALANT

A primerless, cold applied polyurethane. High green strength. FMVSS 208 4-hour drive away time.

Item # 1377641 310 ml cartridge

Terostat® 8597 PL HMLC Direct Glazing Adhesive

POLYURETHANE ADHESIVE/SEALANT

A cold applied, high modulus, low conductivity polyurethane. Primer recommended for glass adhesion. FMVSS 208 1-hour drive away time.

Item # 1377642 310 ml cartridge

Terostat® 8599 Direct Glazing Adhesive

POLYURETHANE ADHESIVE/SEALANT

A warm applied, very fast-curing polyurethane. Primer recommended for glass adhesion. FMVSS 208 15-minute drive away time.

Item # 1377643 310 ml cartridge
 1371250 25 kg pail
 1377390 245 kg drum

[Primers]

Terostat® 8519 P Primer/Activator

Improves adhesion of polyurethane adhesive/sealants on glass, glass ceramics, metals, and plastics (trials recommended). Activator for polyurethane-coated glass and residual beads. Black in color.

Item # 1418666 250 ml bottle
 1418664 1 L bottle

Terostat® 8517 H Glass Primer

Improves adhesion of polyurethane adhesive/sealants on glass, glass ceramics, metals and plastics (trials recommended). Black in color.

Item # 1418667 250 ml bottle

Terostat® 8521 Painted Substrate Primer

Improves adhesion of polyurethane adhesive/sealants on painted substrates and plastics (trials recommended). Black in color.

Item # 1418668 250 ml bottle

[Loctite® Windshield Glass Installation Adhesive Properties Chart]







LOCTITE® PRODUCT	ITEM NUMBER	PACKAGE TYPE/SIZE	FEATURE	CHEMISTRY	HARDNESS, SHORE A	TENSILE STRENGTH	ELONGATION	SKIN FORMATION	DRIVE AWAY TIME (WITH/WITHOUT AIRBAGS)	AGENCY APPROVALS
TEROSTAT® 9000 PL HMLC	1370891 1430053	310 ml cartridge 25 kg pail	Primerless, isocyanate and solvent-free, cold applied	MS Polymer	70	900 psi	220%	15 minutes	2 hours	FMVSS 208
TEROSTAT® 9096 PL	1377641	310 ml cartridge	Primerless, cold applied	Polyurethane	60	1,000 psi	350%	20 minutes	4 hours	FMVSS 208
TEROSTAT® 8597 HMLC WITH TEROSTAT® 8517H PRIMER	1377642	310 ml cartridge	Cold applied	Polyurethane	70	1,300 psi	350%	25 minutes	2 hours/1 hour	FMVSS 208
TEROSTAT® 8599	1377643 1371250 1377390	310 ml cartridge 25 kg pail 245 kg drum	Very fast, warm applied	Polyurethane	60	1,200 psi	300%	20 minutes	15 minutes	FMVSS 208

ITEMS IN RED = Source's PICK or NEW

[Loctite® Windshield Glass Installation Primers Properties Chart]

LOCTITE® PRODUCT	ITEM NUMBER	PACKAGE TYPE/SIZE	FEATURE
TEROSTAT® 8519 P	1418666 1418664	250 ml bottle 1 L bottle	All-in-one primer and activator
TEROSTAT® 8517 H	1418667	250 ml bottle	Glass primer
TEROSTAT® 8521	1418668	250 ml bottle	Painted substrate primer

Your Source for GASKETING & SEALING **DGX EQUIPMENT**

LOCTITE® PRODUCT	ITEM NUMBER	PACKAGE TYPE/SIZE	USED TO DISPENSE	VISCOSITY	TYPE	CONSUMABLES - DISPENSE ACCESSORIES
 CARTRIDGE PREHEATER	1271651	300/310 ml cartridge	MS Polymer Polyurethane	All	Electric	Cartridge Accessories - Page 183
 PNEUMATIC HANDHELD 300 ML DISPENSER	1294304	300 ml cartridges 250 ml tubes	MS Polymer Polyurethane	Medium to High	Pneumatic	
 POWERLINE II 300 ML DISPENSER	960304	300/310 ml cartridge	MS Polymer Polyurethane	Medium to Very High	Pneumatic - mechanical	
 PRIMER APPLICATORS	142245	N/A	MS Polymer Polyurethane	All	Manual	
 CARTRIDGE OPENER	395397	N/A	MS Polymer Polyurethane	N/A	Manual	
 CUTTING WIRE FOR GLASS REMOVAL	149361	N/A	N/A	N/A	Manual	

EQUIPMENT & ACCESSORIES

Your Source for LUBRICATING

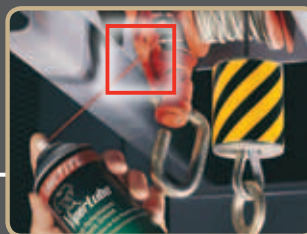

[Table of Contents]

LUBRICATING	91
ANTI-SEIZE	93
LUBRICANTS	97

[Lubricants]

Loctite® lubricants offer superior protection for industrial equipment. When choosing a lubricant, it is important to consider the intended application as well as the environment of the application. The typical function of a lubricant is to protect against friction and wear; however, in an industrial environment, there are other factors working against the product, including high temperature, harsh chemicals and contaminants. Lubricants are also used to protect against corrosion by displacing moisture and leaving a film on the part.

BENEFITS OF A SYNTHETIC LUBRICANT

- Improved high temperature performance
- Higher lubricity
- Superior water-washout properties
- Higher purity

Your Source LUBRICATION GUIDE

WHAT TYPE OF LUBRICATION IS NEEDED?

Dry Film	Grease	Penetrating Oils
Loctite® Moly Dry Film Lubricant Item # 39895 12 oz. net wt. aerosol 39896 1.3 lb. can 39897 10 lb. can	SPECIALTY Loctite® Dielectric Grease Item # 30536 0.33 oz. tube 37535 3 oz. tube Loctite® Extreme Pressure Grease Item # 51242 14.5 oz. cartridge Loctite® Food Grade Grease Item # 51252 14.5 oz. cartridge Loctite® Hydraulic Jack Oil Item # 30523 1 gallon can Loctite® 5th Wheel Grease Item # 1291112 3.5 oz. pouch Loctite® Trailer Jack Stand Grease Item # 1289249 400 ml cartridge	Loctite® Penetrating Oil Item # 51221 12 oz. net wt. aerosol Loctite® Solvo-Rust® Super Penetrating Oil Item # 81252 12.25 oz. net wt. aerosol Loctite® Maintain® Lubricant Penetrant Item # 81204 16 oz. net wt. aerosol Loctite® Freeze & Release™ Item # 996456 13.52 oz. net wt. aerosol
Krytox® RFE Advanced PTFE Dry Lubricant Item # 30138 8 oz. net wt. aerosol	HIGH PERFORMANCE Loctite® ViperLube® High Performance Synthetic Grease Item # 36780 1 cc tube 36781 3 oz. tube 36782 14 oz. cartridge 36783 400 g can 36784 0.42 oz. tube 36786 10.1 oz. net wt. aerosol 37061 30 lb. pail 37710 120 lb. drum Loctite® ViperLube® Clear High Performance Synthetic Grease Item # 39341 3 oz. tube 39342 400 g cartridge	General-Purpose Loctite® Gear, Chain and Cable Lubricant Item # 81251 12 oz. net wt. aerosol Loctite® Silicone Lubricant Item # 51360 150 g tube 81246 13 oz. net wt. aerosol Loctite® White Lithium Grease Item # 30530 1.5 oz. tube 30543 10.75 oz. net wt. aerosol
Loctite® C-200® High Temperature Solid Film Lubricant Item # 39893 1.3 lb. can 39894 10 lb. can	SEVERE CHEMICAL CONTACT Krytox® RFE PTFE Lubricant (O-Ring Lubricant) Item # 29710 2 oz. tube 31361 16 oz. cartridge Krytox® RFE PTFE High Performance Lubricant Item # 29711 2 oz. tube 29709 16 oz. cartridge	

PLEASE NOTE: The charts on these two pages should not be used to specify products without specific testing. It is recommended that you conduct on-part testing to ensure product performance before specifying any anti-seize or lubricating product.



Your Source ANTI-SEIZE GUIDE

WHAT TYPE OF ANTI-SEIZE PROTECTION IS NEEDED?

General-Purpose

UP TO 1600°F

Loctite® Silver Grade Anti-Seize & Loctite® QuickStix® Silver Anti-Seize

Item #	
38181	7 g pouch
80209	4 oz. brush-top can
76732	8 oz. brush-top can
76759	12 oz. net wt. aerosol
76764	1 lb. brush-top can
80206	1 gallon can
76775	5 gallon pail
37230	20 g stick – QuickStix®
39223	40 g stick – QuickStix®

UP TO 1800°F

Loctite® C5-A® Copper-Based Anti-Seize Lubricant & Loctite® QuickStix® C5-A® Copper-Based Anti-Seize

Item #	
51299	2 g pouch
51277	7 g pouch
51001	1 oz. tube
51002	4 oz. tube
51144	4 oz. brush-top can
51147	8 oz. brush-top can
51005	10 oz. brush-top can
51003	12 oz. net wt. aerosol
51004	13 oz. cartridge
51006	1 lb. can
51007	1 lb. brush-top can
39643	1 lb. brush-top metal can
51008	2.5 lb. can
51009	8 lb. can
38584	25 lb. pail
51011	42 lb. pail
51146	425 lb. drum
37229	20 g stick – QuickStix®
39222	40 g stick – QuickStix®

UP TO 2000°F

Loctite® White Hi-Temp Anti-Seize

Item #	
34517	8 oz. brush-top can
34518	16 oz. brush-top can

METAL-FREE

UP TO 2400°F

Loctite® Nickel Anti-Seize

Item #	
77124	8 oz. brush-top can
51286	12 oz. net wt. aerosol
51102	1 lb. can
77164	1 lb. brush-top can
51152	8 lb. can
77175	5 gal. pail

ELECTRICALLY CONDUCTIVE

Loctite® Graphite-50™ Anti-Seize

Item #	
51084	1 lb. can

METAL-FREE

Power Plant

UP TO 1800°F

Loctite® N-1000™ High Purity Anti-Seize

Item #	
51115	8 oz. brush-top can
51116	1 lb. can
51117	2 lb. can

UP TO 2400°F

Loctite® N-5000™ High Purity Anti-Seize

Item #	
51346	1 oz. tube
51243	8 oz. brush-top can
51269	1 lb. brush-top can
51246	2 lb. can
51245	8 lb. can

UP TO 2400°F / HIGH LUBRICITY

Loctite® High Performance N-5000™ High Purity Anti-Seize

Item #	
51572	1 lb. brush-top can

UP TO 2400°F / HIGH PURITY

Loctite® High Performance N-7000™ High Purity Anti-Seize

Item #	
51272	8 oz. brush-top can
51270	1 lb. brush-top can
51273	2 lb. can

METAL-FREE

Soft Metal

Loctite® Silver Grade Anti-Seize

Item #	
38181	7 g pouch
80209	4 oz. brush-top can
76732	8 oz. brush-top can
76759	12 oz. net wt. aerosol
76764	1 lb. brush-top can
80206	1 gallon can
76775	5 gallon pail

Water-Resistant

Loctite® Marine Grade Anti-Seize

Item #	
34395	8 oz. brush-top can
34026	16 oz. brush-top can

METAL-FREE

Incidental Food Contact

Loctite® Food Grade Anti-Seize

Item #	
1167237	8 oz. brush-top can
1169241	2 lb. can
1170163	40 lb. pail

METAL-FREE

Up to 750°F

THREAD LUBRICANT

Loctite® Moly-50™ Anti-Seize

Item #	
51094	1 lb. can

METAL-FREE

EXTREME PRESSURE

Loctite® Moly Paste

Item #	
51050	12 oz. net wt. aerosol
51048	8 oz. brush-top can
51049	1 lb. brush-top can
51145	15 lb. can

METAL-FREE

Stainless Steel and Titanium

Loctite® Heavy-Duty Anti-Seize & Loctite® QuickStix® Heavy Duty Anti-Seize

Item #	
51609	1 oz. tube
51605	9 oz. brush-top can
51606	18 oz. brush-top can
51607	2.3 lb. can
51608	45 lb. pail
41205	20 g stick – QuickStix®

METAL-FREE

[Anti-Seize]

Loctite® anti-seize products provide protection against rust, corrosion, seizing and galling, as well as lubrication. Anti-seizes are typically the products of choice for high temperature applications because of their unique ability to provide protection in extreme temperature conditions. Each product contains a combination of solid lubricating agents resulting in different high temperature limits and lubricities. These are the two major factors in choosing the right anti-seize product for your application.

METAL-FREE

The “Metal-Free” products utilize nonmetallic fillers to achieve high temperature resistance properties as well as lubricity. These fillers typically provide a much higher temperature resistance than that of metallic fillers and, due to the less abrasive nature of these fillers, they also typically provide lower K-values, resulting in higher lubricity.

Loctite® Adhesives and Sealants Product Specialists are available to assist you. For application assistance, call 1-800-LOCTITE (562-8483); within Canada, call 1-800-263-5043; or, contact us through the web at www.henkelna.com/loctite.

STRAIGHT FROM *The Source*

Your Source for LUBRICATING ANTI-SEIZE

- Protect against rust, corrosion, seizing and galling
- Provide lubrication in extreme environments



[General-Purpose]

Source's PICK **Loctite® C5-A® Copper-Based Anti-Seize Lubricant**

Exclusive formula suspends copper and graphite in a high quality grease. Protects metal parts from rust, corrosion, galling and seizing at temperatures to 1800°F (982°C).

Item #	51299	2 g pouch
	51277	7 g pouch
	51001	1 oz. tube
	51002	4 oz. tube
	51144	4 oz. brush-top can
	51147	8 oz. brush-top can
	51005	10 oz. brush-top can
	51003	12 oz. net wt. aerosol
	51004	13 oz. cartridge
	51006	1 lb. can
	51007	1 lb. brush-top can
	39643	1 lb. brush-top metal can
	51008	2.5 lb. can
	51009	8 lb. can
	38584	25 lb. pail
	51011	42 lb. pail
	51146	425 lb. drum

Loctite® Silver Grade Anti-Seize

Heavy-duty, temperature-resistant, petroleum-based lubricant compound fortified with graphite and metallic flake. Inert; will not evaporate or harden in extreme cold or heat. For use in assemblies up to 1600°F (871°C).

Item #	38181	7 g pouch
	80209	4 oz. brush-top can
	76732	8 oz. brush-top can
	76759	12 oz. net wt. aerosol
	76764	1 lb. brush-top can
	80206	1 gallon can
	76775	5 gallon pail

Loctite® Nickel Anti-Seize

Copper-free. Recommended for stainless steel and other metal fittings. For preventing corrosion, seizing and galling in harsh chemical environments and temperatures to 2400°F (1315°C).

Item #	77124	8 oz. brush-top can
	51286	12 oz. net wt. aerosol
	51102	1 lb. can
	77164	1 lb. brush-top can
	51152	8 lb. can
	77175	5 gallon pail

Loctite® QuickStix® C5-A® Copper-Based Anti-Seize

The same trusted performance characteristics as the Loctite® C5-A® Copper Anti-Seize paste in a convenient semisolid stick form. Stick package offers more portability and less mess.

Item #	37229	20 g stick
	39222	40 g stick

Loctite® QuickStix® Silver Grade Anti-Seize

New semisolid stick offers the same performance characteristics as the Loctite® Silver Grade Anti-Seize paste in a convenient semisolid stick form. Stick package offers more portability and less mess.

Item #	37230	20 g stick
	39223	40 g stick

[High Performance]

Source's PICK **Loctite® Heavy-Duty Anti-Seize**

Excellent lubricity. Metal-free formulation provides outstanding lubrication to all metals including stainless steel aluminum, and soft metals up to 2400°F (1315°C).

Item #	51609	1 oz. tube
	51605	9 oz. brush-top can
	51606	18 oz. brush-top can
	51607	2.3 lb. can
	51608	45 lb. pail

Loctite® QuickStix® Heavy Duty Anti-Seize

New semisolid stick offers the same performance characteristics as the Loctite® Heavy Duty Anti-Seize paste in a convenient semisolid stick form. Stick package offers more portability and less mess.

Item #	41205	20 g stick
--------	-------	------------

Loctite® Marine Grade Anti-Seize

Metal-free formulation to protect assemblies exposed directly or indirectly to fresh and salt water, Loctite® Marine Grade Anti-Seize works especially well in high humidity conditions. It has excellent lubricity, superior water-washout and water spray resistance and prevents galvanic corrosion. Protects in temperatures from -20°F to 2400°F (-29°C to 1315°C).

Item #	34395	8 oz. brush-top can
	34026	16 oz. brush-top can

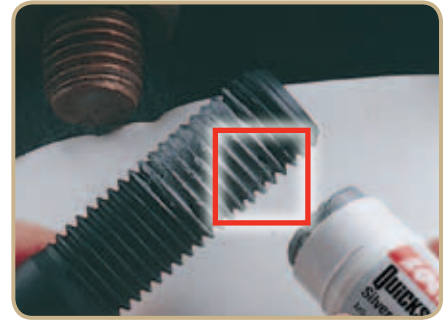
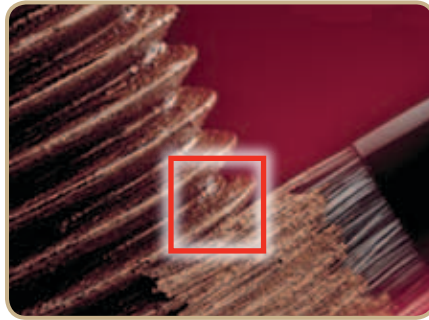

[Applications]

- Pump
- Gearbox
- Concrete Repair
- Conveyor Systems
- Shaft Repair

[Industries]

- Mining
- Wastewater
- Power Generation

- Food Processing
- Pulp and Paper
- Beverage

APPLICATIONS
& INDUSTRIES

Loctite® White Hi-Temp Anti-Seize

Metal-free, general-purpose, nonmetallic formulation that protects against high temperature seizing and galling of mated metal parts up to 2000°F (1093°C). White in color, it has excellent lubricity and can be used on various metals such as copper, brass, cast iron, steel, and all alloys including stainless steel.

Item # 34517 8 oz. brush-top can
Item # 34518 16 oz. brush-top can

[Specialty]

Source's PICK Loctite® Food Grade Anti-Seize

Metal-free formulation prevents seizure, galling, and friction in stainless steel and other metal parts up to 750°F (400°C).

Item # 1167237 8 oz. brush-top can
Item # 1169241 2 lb. can
Item # 1170163 40 lb. pail

Loctite® Graphite-50™ Anti-Seize

Metal-free, electrically conductive, non-metallic. Temperature resistant up to 900°F (482°C). Highly electrically conductive in metal-to-metal joints.

Item # 51084 1 lb. can

Source's PICK Loctite® Moly Paste

Metal-free, very low friction. Lubricates press fits, protects during break-in and under high static loads up to 750°F (400°C). Allows maximum clamping from available torque.

Item # 51050 12 oz. net wt. aerosol
Item # 51048 8 oz. brush-top can
Item # 51049 1 lb. brush-top can
Item # 51145 15 lb. can

Loctite® Moly-50™ Anti-Seize

Metal-free, general-purpose thread lubricant. Temperature resistant to 750°F (400°C). Provides excellent lubricity.

Item # 51094 1 lb. can

Loctite® Zinc Anti-Seize

Protects aluminum and ferrous surfaces from seizure and corrosion up to 750°F (400°C).

Item # 39901 1 lb. can

[High Purity]

Source's PICK Loctite® N-7000™ High Purity Anti-Seize

Metal-free formulation provides high levels of purity and excellent lubricating properties. For Class 1, 2 and 3 power plant hardware. Temperature resistant to 2400°F (1315°C).

Item # 51272 8 oz. brush-top can
Item # 51270 1 lb. brush-top can
Item # 51273 2 lb. can

Loctite® N-5000™ High Purity Anti-Seize

Nickel-based. Lubricates and protects Class 1, 2 and 3 power plant hardware. Recommended for highly corrosive environments to 2400°F (1315°C).

Item # 51346 1 oz. tube
Item # 51243 8 oz. brush-top can
Item # 51269 1 lb. brush-top can
Item # 51246 2 lb. can
Item # 51245 8 lb. can

Loctite® High Performance N-5000™ High Purity Anti-Seize

Maximum lubricating and anti-seize properties for Class 1, 2 and 3 power plant hardware. Temperature resistant to 2400°F (1315°C).

Item # 51572 1 lb. brush-top can

Loctite® N-1000™ High Purity Anti-Seize

Certified pure. Copper-based. Suitable for critical, long-term, stainless steel applications and high-nickel, alloy bolting. Recommended for protecting Class 2 and 3 power plant hardware. Temperature resistant to 1800°F (982°C).

Item # 51115 8 oz. brush-top can
Item # 51116 1 lb. can
Item # 51117 2 lb. can

ANTI-SEIZE IS OFTEN USED...

- As a gasket release agent in instances where reuse of the gasket is desirable
- Recommended for use on spark plug threads and electrical connections

HELPFUL HINTS

Your Source for **LUBRICATING
ANTI-SEIZE**

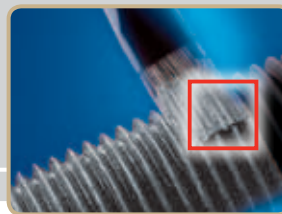

[Loctite® Anti-Seize Properties Chart]

	LOCTITE® PRODUCT	ITEM NUMBER	PACKAGE TYPE/SIZE	TEMPERATURE RESISTANCE	COLOR	K-VALUE*							
GENERAL-PURPOSE	C5-A° COPPER-BASED ANTI-SEIZE LUBRICANT	51299 51277 51001 51002 51144 51147 51005 51003 51004 51006 51007 39643 51008 51009 38584 51011 51146	2 g pouch 7 g pouch 1 oz. tube 4 oz. tube 4 oz. brush-top can 8 oz. brush-top can 10 oz. brush-top can 12 oz. net wt. aerosol 13 oz. cartridge 1 lb. can 1 lb. brush-top can 1 lb. brush-top metal can 2.5 lb. can 8 lb. can 25 lb. pail 42 lb. pail 425 lb. drum	1800°F (982°C)	Copper	0.16							
	QUICKSTIX® C5-A° COPPER-BASED ANTI-SEIZE	37229 39222	20 g stick 40 g stick										
	SILVER GRADE ANTI-SEIZE	38181 80209 76732 76759 76764 80206 76775	7 g pouch 4 oz. brush-top can 8 oz. brush-top can 12 oz. net wt. aerosol 1 lb. brush-top can 1 gallon can 5 gallon pail				1600°F (871°C)	Silver	0.18				
	QUICKSTIX® SILVER GRADE ANTI-SEIZE	37230 39223	20 g stick 40 g stick										
	HIGH PERFORMANCE	NICKEL ANTI-SEIZE	77124 51286 51102 77164 51152 77175				8 oz. brush-top can 12 oz. net wt. aerosol 1 lb. can 1 lb. brush-top can 8 lb. can 5 gallon pail	2400°F (1315°C)	Silver	0.13			
		HEAVY DUTY ANTI-SEIZE	51609 51605 51606 51607 51608				1 oz. tube 9 oz. brush-top can 18 oz. brush-top can 2.3 lb. can 45 lb. pail				2400°F (1315°C)	Black	0.16
		QUICKSTIX® HEAVY DUTY ANTI-SEIZE	41205				20 g stick						
		MARINE GRADE ANTI-SEIZE	34395 34026				8 oz. brush-top can 16 oz. brush-top can				2400°F (1315°C)	Black	0.18
		WHITE HI-TEMP ANTI-SEIZE	34517 34518				8 oz. brush-top can 16 oz. brush-top can						
	SPECIALTY	FOOD GRADE ANTI-SEIZE	1167237 1169241 1170163				8 oz. brush-top can 2 lb. can 40 lb. pail	750°F (400°C)	White	0.13			
GRAPHITE-50™ ANTI-SEIZE		51084	1 lb. can	900°F (482°C)	Black	0.13							
MOLY PASTE		51050 51048 51049 51145	12 oz. net wt. aerosol 8 oz. brush-top can 1 lb. brush-top can 15 lb. can	750°F (400°C)	Black	0.11							
MOLY-50™ ANTI-SEIZE		51094	1 lb. can				750°F (400°C)	Black	0.13				
ZINC ANTI-SEIZE		39901	1 lb. can	750°F (400°C)	Grey	0.15							
HIGH PURITY		N-7000™ HIGH PURITY ANTI-SEIZE	51272 51270 51273	8 oz. brush-top can 1 lb. brush-top can 2 lb. can	2400°F (1315°C)	Silver	0.16						
	N-5000™ HIGH PURITY ANTI-SEIZE	51346 51243 51269 51246 51245	1 oz. tube 8 oz. brush-top can 1 lb. brush-top can 2 lb. can 8 lb. can	2400°F (1315°C)				Silver	0.15				
	HIGH PERFORMANCE N-5000™ HIGH PURITY ANTI-SEIZE	51572	1 lb. brush-top can		2400°F (1315°C)	Silver	0.15						
	N-1000™ HIGH PURITY ANTI-SEIZE	51115 51116 51117	8 oz. brush-top can 1 lb. can 2 lb. can		1800°F (982°C)	Copper	0.17						

ITEMS IN RED = Source's PICK or NEW

* See K-Value on next page.

Loctite® Industrial Hand Wipes

Clean hands anywhere! Quick and easy to use – no rinsing, drying or residue. Each 9 1/2 in. x 12 in. towel is pre-moistened with powerful citrus-scented cleaning formula. Towels are abrasive enough to scrub off the toughest grease and grime.



Item # 34943 75 count
34944 130 count

ADDITIONAL RESOURCES

[Loctite® Anti-Seize Application Chart]

	LOCTITE® PRODUCT	MAXIMUM ANTI-SEIZE PROPERTIES	FOR MAXIMUM LUBRICITY	FOR LOW SPEEDS, HIGH LOADS	EXTREME HIGH TEMPERATURE RESISTANCE (TO 2000°F-2400°F)	EXTREME CHEMICAL RESISTANCE	ELECTRICALLY CONDUCTIVE	FOR ALUMINUM/ SOFT METALS	FOR STAINLESS STEEL	METAL-FREE FORMULATION	COPPER-FREE FORMULATION	KEY SPECIFICATIONS & AGENCY APPROVALS
GENERAL-PURPOSE	C5-A° COPPER-BASED ANTI-SEIZE LUBRICANT	△					△	△	△			CFIA (QuickStix®)
	SILVER GRADE ANTI-SEIZE	△					△	△	△			ABS, CFIA
	NICKEL ANTI-SEIZE	△			▲	▲	△		△		▲	ABS
HIGH PERFORMANCE	HEAVY-DUTY ANTI-SEIZE	▲			▲	△	△	△	▲	▲	▲	N/A
	MARINE GRADE ANTI-SEIZE	▲			▲			△	▲	▲	▲	ABS
	WHITE HI-TEMP ANTI-SEIZE	△			▲			△	△	▲	▲	N/A
SPECIALTY	FOOD GRADE ANTI-SEIZE	■						△	▲	▲	▲	NSF® H1, CFIA
	GRAPHITE-50™ ANTI-SEIZE	■				△	▲	△		▲	▲	N/A
	MOLY PASTE	■	▲	▲					▲	▲	▲	N/A
	MOLY-50™ ANTI-SEIZE	■	△	△					▲	▲	▲	N/A
	ZINC ANTI-SEIZE	■					■	▲	△			N/A
HIGH PURITY	N-7000™ HIGH PURITY ANTI-SEIZE	▲			▲	△	△		△	▲	▲	N/A
	N-5000™ HIGH PURITY ANTI-SEIZE	△			▲	▲	△		△		▲	N/A
	HIGH PERFORMANCE N-5000™ HIGH PURITY ANTI-SEIZE	▲	▲		▲	▲	△		△		▲	N/A
	N-1000™ HIGH PURITY ANTI-SEIZE	△					△		△			N/A

ITEMS IN RED = Source's PICK or NEW △ Good Choice ▲ Preferred Choice ■ Acceptable Choice

Torque Guide

Proper clamp load is an essential part of any bolted assembly for trouble-free operations. Torquing either nut or bolt creates the clamp load. An anti-seize lubricant used on a bolt helps to develop greater clamp load for the same torque compared to a non-lubricated bolt. An additional benefit is greater uniformity in clamp load among a series of bolts. The relationship between torque and clamp load is expressed in the following equation: $T = KFD$.

Where:

- T = Torque (in.-lb., ft.-lb., N-m)
- F = Clamp Load (lb., N)
- D = Nominal diameter of bolt (in., ft., m)
- K = Torque coefficient or nut factor, determined experimentally

K Factors: K factors are obtained on Grade 8, 1/2 in. steel bolts and grade 5 nuts by a test procedure that measures torque tension properties. Lubricant was applied to the bolt threads and both faces of the washer.

See the Properties Chart for the torque coefficient or K value for the anti-seize compounds.

Henkel Corporation believes that this data fairly represents performance to be expected. However, Henkel makes no warranty of specific performance on any individual fastener. In critical applications, it is necessary to determine K values independently.

Note: There are two "coefficients" used to express the relationship between torque and tension: torque coefficient (also called "nut factor") is the most commonly used. A different concept is the "friction coefficient," which has a value of 2/3 (or 67%) of the torque coefficient.

ADDITIONAL RESOURCES

Your Source for LUBRICATING LUBRICANTS



[Synthetic / High Performance]

Loctite® ViperLube® High Performance Synthetic Grease

NLGI grade 2/severe duty GC-LB grease provides superior protection for equipment exposed to a wide range of operating temperatures and environments. Use as a lubricant and protective anti-rust film on bearings, machine parts, equipment, or as a release agent on gaskets and seals. **NSF® H1 rated for incidental food contact.**

Item #	36780	1 cc tube
	36781	3 oz. tube
	36782	14 oz. cartridge
	36783	400 g can
	36784	0.42 oz. tube
	36786	10.1 oz. net wt. aerosol
	37061	30 lb. pail
	37710	120 lb. drum

Loctite® ViperLube® Clear High Performance Synthetic Grease

Lasts four times longer than petroleum-based lubricants. Withstands temperatures up to 420°F (520°F intermittent). Contains PTFE for added protection against friction and wear. Nonflammable. Contains no ozone-depleting compounds. **NLGI #2 grade grease. Opaque white in color.**

Item #	39341	3 oz. tube
	39342	400 g cartridge

[Petroleum-Based Greases]

Loctite® White Lithium Grease

General-purpose lubricating paste for metal-to-metal and metal-to-plastic applications. Provides corrosion protection. Contains no ozone-depleting compounds.

Item #	30530	1.5 oz. tube
	30543	10.75 oz. net wt. aerosol

Loctite® Dielectric Grease

Provides a moisture-proof barrier that lubricates and protects electrical equipment from salt, dirt and corrosion. High dielectric strength. Good thermal, oxidation and chemical stability.

Item #	30536	0.33 oz. tube
	37535	3 oz. tube

Loctite® Extreme Pressure Grease

Lubricates gears, bearings and slides up to 450°F (232°C). NLGI Grade 1 rated. Withstands extremes of pressure and resists water-washout. Maintains pumpability at low temperatures; will not take a hard set after cooling.

Item #	51242	14.5 oz. cartridge
--------	-------	--------------------

Loctite® 5th Wheel Grease

Moly filled petroleum-based grease in a convenient 3.5 oz. pouch. For superior water washout resistance and performance.

Item #	1291112	3.5 oz. pouch
--------	---------	---------------

Loctite® Trailer Jack Stand Grease

Petroleum-based grease designed for long life and superior lubrication on trailer/jack stands.

Item #	1289249	400 ml cartridge
--------	---------	------------------

Loctite® Food Grade Grease

Extreme pressure grease with temperature resistance to 450°F (232°C). NLGI Grade 2 rated. Protects after flush-outs and steam cleaning. **NSF® H1 rated for incidental food contact. CFIA approved.**

Item #	51252	14.5 oz. cartridge
--------	-------	--------------------

Loctite® Maintain® Lubricant Penetrant

MOISTURE DISPLACER AND RUST PREVENTER

Spray-on rust preventative for all metal parts. Unfreezes rusted parts; displaces and seals out moisture. For use on steel, aluminum, brass, copper, magnesium, and other metals and alloys. Contains no ozone-depleting compounds. **CFIA approved.**

Item #	81204	16 oz. net wt. aerosol
--------	-------	------------------------

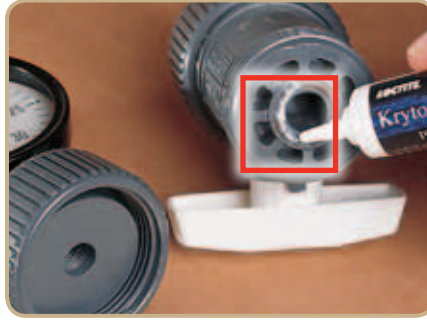

[Applications]

- Pump
- Gearbox
- Concrete Repair
- Conveyor Systems
- Shaft Repair

[Industries]

- Mining
- Wastewater
- Power Generation

- Food Processing
- Pulp and Paper
- Beverage

[Specialty Oils & Lubricants]

Krytox® RFE PFPE Lubricant and High Performance Lubricant

This grease lubricant has excellent lubrication properties over a broad temperature range, will not cause cracking or swelling, and contains a corrosion inhibitor to protect against undue wear. Eliminates sticking and aids in disassembly. Nonflammable, chemically inert. Compatible with chlorine. Specially formulated high performance lubricant designed to provide long-lasting lubrication for all types of moving and/or sliding parts. See product description sheet for test results.

Item #	29710	2 oz. tube
	31361	16 oz. cartridge
	29711	High Performance 2 oz. tube
	29709	High Performance 16 oz. cartridge

Krytox® RFE Advanced PTFE Dry Lubricant

A high performance, synthetic lubricant designed to provide long-lasting lubrication for parts that require a dry, thin lubricating film. This lubricant provides excellent lubrication properties over a broad temperature range, and dries to the touch in 60 seconds. It is non-oily, non-staining, non-migrating and will not attract dirt or dust.

Item #	30138	8 oz. net wt. aerosol
--------	-------	-----------------------

Loctite® Gear, Chain and Cable Lubricant

Protects and prolongs the life of gears, chains, wire rope and cable. Repels dirt, sand and dust with minimal “throw-off” from centrifugal force. Contains no ozone-depleting compounds.

Item #	81251	12 oz. net wt. aerosol
--------	-------	------------------------

Loctite® Silicone Lubricant

Multipurpose lubricant stops sticking, friction, squeaking and binding of moving parts. Non-gumming. Will not mar paint, rubber or plastic surfaces. Waterproofs and electrically insulates. *CFIA approved.*

Item #	51360	150 g tube
	81246	13 oz. net wt. aerosol

Loctite® Moly Dry Film Lubricant

Solid film lubricant for sliding surfaces and slow moving parts. Temperature resistant up to 750°F (400°C) as a dry film lubricant, and 2400°F (1315°C) as an anti-seize. Won't squeeze out, burn off or pick up dirt.

Item #	39895	12 oz. net wt. aerosol
	39896	1.3 lb. can
	39897	10 lb. can

Loctite® Solvo-Rust® Super Penetrating Oil

Frees rusted parts and keeps them lubricated and protected from rust after use. May be applied on or near moving parts. Will not harm painted surfaces. Contains no ozone-depleting compounds. *CFIA approved.*

Item #	81252	12.25 oz. net wt. aerosol
--------	-------	---------------------------

Loctite® C-200® High Temperature Solid Film Lubricant

Solid film protection for engine parts, bearings and servo-mechanisms. Temperature resistant up to 750°F (400°C) as a dry film lubricant, and 2400°F (1315°C) as an anti-seize.

Item #	39893	1.3 lb. can
	39894	10 lb. can

Loctite® Penetrating Oil

Penetrates, lubricates and displaces moisture. Protects against rust and corrosion. Contains no ozone-depleting compounds.

Item #	51221	12 oz. net wt. aerosol
--------	-------	------------------------

Loctite® Freeze & Release

FAST-ACTING CORROSION RELEASE

Instantly chills seized and rusted parts (bolts, nuts, studs) down to -45°F (-43°C). The exceptional shock-freeze action causes microscopic cracks in the layer of rust, allowing the lubricating ingredient to wick directly into the rust by capillary action.

Item #	996456	13.52 oz. net wt. aerosol
--------	--------	---------------------------

Your Source for **LUBRICATING LUBRICANTS**



[**Loctite® ViperLube® Synthetic Lubricants Properties Chart**]

LOCTITE® PRODUCT	ITEM NUMBER	PACKAGE TYPE/SIZE	TEMPERATURE RESISTANCE	TYPE OF LUBRICANT	VISCOSITY RANGE	POUR POINT (ASTM D 97)	FOUR BALL TEST	NLGI RATING	DROP POINT	SPRAY TEST (ASTM B111)	AGENCY APPROVALS
SYNTHETIC / HIGH PERFORMANCE VIPERLUBE® HIGH PERFORMANCE SYNTHETIC GREASE	36780	1 cc tube	400°F (204°C) continuous	Synthetic hydrocarbon (polyalphaolefin based)	240 CST	N/A	0.45 mm (ASTM D 2266)	2	500°F (260°C) (ASTM D 556)	Pass	NSF® H1, CFIA
	36781	3 oz. tube									
	36782	14 oz. cartridge	500°F (260°C) intermittent								
	36783	400 g can									
	36784	0.42 oz. tube									
	36786	10.1 oz. net wt. aerosol									
37061	30 lb. pail										
37710	120 lb. drum										
SYNTHETIC / HIGH PERFORMANCE VIPERLUBE® CLEAR HIGH PERFORMANCE SYNTHETIC GREASE	39341	3 oz. tube	420°F (216°C) continuous 520°F (271°C) intermittent	Synthetic hydrocarbon (polyalphaolefin based)	N/A	N/A	0-60 mm (ASTM D 2266)	2	<590°F (<310°C) (ASTM D 2265)	N/A	NSF® H1, CFIA
	39342	400 g cartridge									

[**Grease Compatibility Chart**]

THICKENER TYPE	CALCIUM SULFONATE VIPERLUBE®	SILICA GEL VIPERLUBE® CLEAR	LITHIUM SOAP	LITHIUM COMPLEX	ALUMINUM COMPLEX	CALCIUM COMPLEX	BARIUM SOAP	SODIUM SOAP	BENTONE	POLYUREA
CALCIUM SULFONATE VIPERLUBE®		SC	FC	FC	NC	FC	SC	NC	NC	NC
SILICA GEL VIPERLUBE® CLEAR	SC		FC	FC	FC	NC	FC	NC	FC	NA
LITHIUM SOAP	FC	FC		FC	NC	FC	SC	NC	NC	SC
LITHIUM COMPLEX	FC	FC	FC		NC	FC	SC	NC	NC	SC
ALUMINUM COMPLEX	NC	FC	NC	NC		NC	NC	SC	NC	NC
CALCIUM COMPLEX	FC	NC	FC	FC	NC		SC	NC	NC	SC
BARIUM SOAP	SC	FC	SC	SC	NC	SC		NC	NC	NA
SODIUM SOAP	NC	NC	NC	NC	SC	NC	NC		NC	NC
BENTONE	NC	FC	NC	NC	NC	NC	NC	NC		NC
POLYUREA	NC	NA	SC	SC	NC	SC	NA	NC	NC	

FC = Fully Compatible

NC = Not Compatible (Mixtures soften severely and do not remain grease-like.)

SC = Somewhat Compatible (Mixtures soften but remain grease-like.)

NA = Not Available

[**Krytox® RFE Lubricants Properties Chart**]

LOCTITE® PRODUCT	ITEM NUMBER	PACKAGE TYPE/SIZE	TEMPERATURE RESISTANCE	NON-FLAMMABLE	HIGH LOAD CAPACITY	CORROSION INHIBITORS	COMPATIBLE WITH ALL PLASTICS, METALS & ELASTOMERS	CHEMICALLY RESISTANT	OXYGEN COMPATIBLE*	THERMALLY STABLE	WATER/STREAM RESISTANT	NLGI GRADE
SPECIALTY OILS AND LUBRICANTS KRYTOX® RFE PFPE LUBRICANT (O-RING)	29710	2 oz. tube	-15°F to 500°F (-26°C to 260°C)	●	●		●	●	●	●	●	2
	31361	16 oz. cartridge										
	KRYTOX® RFE PFPE HIGH PERFORMANCE LUBRICANT	29711 29709	2 oz. tube 16 oz. cartridge	-15°F to 500°F (-26°C to 260°C)		●	●	●	●	●	●	●
KRYTOX® RFE ADVANCED PTFE DRY LUBRICANT	30138	8 oz. net wt. aerosol	-15°F to 500°F (-26°C to 260°C)	Once film is dry			●	●		●	Water-repellent	N/A

* Per BAM 8104-411 & MSFC 106B under specific conditions. Test the proposed application thoroughly before use.

- Dry film lubricants are an ideal choice for “unclean” environments where there is potential for dirt and other contaminants to come in contact with the product. Contaminants will not stick like they would with a standard grease.
- Loctite® Maintain® Lubricant Penetrant is a moisture displacer, rust preventive and an excellent alternative to WD-40®.

HELPFUL HINTS

[Loctite® Lubricants Applications Chart]

LOCTITE® PRODUCT	ITEM NUMBER	PACKAGE TYPE/SIZE	TEMPERATURE RESISTANCE	FOOD PROCESSING EQUIPMENT	CLOSE-FITTING PARTS	HIGH TEMP	ELECTRICALLY CONDUCTIVE	ELECTRICAL EQUIPMENT	GEAR, BEARINGS, CABLE & CONVEYORS	HYDRAULIC UNITS (NOT BRAKES)	FOR HIGH SPEED BEARINGS	FOR LOW SPEEDS & HIGH LOADS	CHAIN-DRIVEN EQUIPMENT	SOLID FILM		
SYNTHETIC / HIGH PERFORMANCE	VIPERLUBE® HIGH PERFORMANCE SYNTHETIC GREASE	36780 36781 36782 36783 36784 36786 37061 37710	1 cc tube 3 oz. tube 14 oz. cartridge 400 g can 0.42 oz. tube 10.1 oz. net wt. aerosol 30 lb. pail 120 lb. drum	400°F (204°C) continuous 500°F (260°C) intermittent	▲	▲	▲	■	■	▲		▲	▲	▲		
	VIPERLUBE® CLEAR HIGH PERFORMANCE SYNTHETIC GREASE	39341 39342	3 oz. tube 400 g cartridge	420°F (216°C) continuous 520°F (271°C) intermittent	▲		▲		▲	▲		▲	▲	▲		
SPECIALTY OILS & LUBRICANTS	GEAR, CHAIN & CABLE LUBRICANT	81251	12 oz. net wt. aerosol	250°F (121°C)					▲				▲			
	SILICONE LUBRICANT	51360 81246	150 g tube 13 oz. net wt. aerosol	400°F (204°C)	▲		■		△				△			
	MOLY DRY FILM LUBRICANT	39895 39896 39897	12 oz. net wt. aerosol 1.3 lb. can 10 lb. can	750°F (400°C)			△	△	▲				△	▲	▲	
	SOLVO RUST® SUPER PENETRATING OIL	81252	12.25 oz. net wt. aerosol	250°F (121°C)		△										
	C-200® HIGH TEMPERATURE SOLID FILM LUBRICANT (FOR UNCLEAN ENVIRONMENTS)	39893 39894	1.3 lb. can 10 lb. can	2400°F (1315°C)			▲	△					△		▲	
	PENETRATING OIL	51221	12 oz. net wt. aerosol	100°F (38°C)		△										
	5TH WHEEL GREASE	1291112	3.5 oz.	450°F		■							▲			
	TRAILER JACK STAND GREASE	1289249	400 g	450°F		■							▲			
FREEZE & RELEASE	996456	13.52 oz. net wt. aerosol	N/A		△											
PETROLEUM-BASED GREASES	WHITE LITHIUM GREASE	30530 30543	1.5 oz. tube 10.75 oz. net wt. aerosol	380°F (193°C) (dropping point)					△			▲	△			
	DIELECTRIC GREASE	30536 37535	0.33 oz. tube 3 oz. tube	400°F (204°C)			■	■	■							
	EXTREME PRESSURE GREASE	51242	14.5 oz. cartridge	450°F (232°C)			■				▲	▲				
	HYDRAULIC JACK OIL	30523	1 gallon can	120°F (48°C)						▲						
	FOOD GRADE GREASE	51252	14.5 oz. cartridge	450°F (232°C)	▲		■				▲					
MAINTAIN® LUBRICANT PENETRANT	81204	16 oz. net wt. aerosol	250°F (121°C)		▲			▲								

△ Good Choice ▲ Preferred Choice ■ Acceptable Choice

CARTRIDGE ACCESSORIES

Go to **page 183** to see Loctite® branded cartridge accessories as well as other Loctite® Branded Consumables.

Can't find what you're looking for? Visit www.equipment.loctite.com or call 1-800-LOCTITE (562-8483).

STRAIGHT FROM *The Source*

Your Source for
**MACHINING
COMPOUNDS**

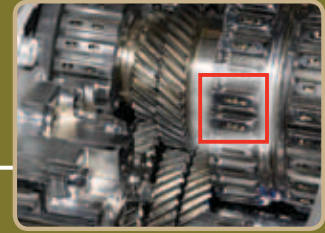
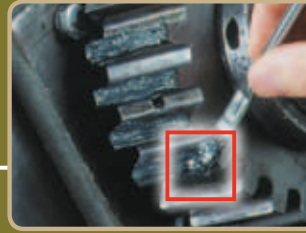

Loctite® Clover® machining compounds (abrading compounds) are abrasive pastes designed especially for the cutting, smoothing and finishing of metal surfaces. They are silicon carbide-filled and are used as a supplemental process to grinding, milling, boring and Electrical Discharge Machining (EDM) on high or low tensile strength materials, including forged or hardened gears. These compounds produce an ultra-flat surface but not a polished one.

HOW DOES GRIT SIZE AFFECT METAL REMOVAL?

Grit size directly relates to the finish left on the metal surface. A very coarse grit, such as our 54 grit, will quickly remove metal from the surface and leave a somewhat rough finish. To achieve a smoother finish, a smaller grit size should be used, such as 1,000 grit. This compound will fill the smaller metal voids and will, therefore, leave a smoother finish.

BENEFITS

- Premixed and ready-to-use for consistent performance that is unattainable from mix-your-own slurries
- Manufactured from premium abrasive grits; only virgin silicon carbide abrasives, carefully sized, are used
- Water-soluble – the compound clings to blades for superior honing action, but washes away easily (Pat Gel® Water Mix only)
- Biodegradable (Pat Gel® Water Mix only)

[Grade & Grit Selector Guide]

GRADE	GRIT	TEXTURE & USE	AVERAGE PARTICLE SIZE OF ABRASIVE GRAINS	
			1/1,000 INCHES	MICRONS (0.001 MM)
7A	1,200	Extremely Fine: For polishing and high precision lapping	0.12	3
6A	1,000		0.20	5
5A	800		0.38	9
4A	600	Very Fine: For fine polishing and lapping	0.56	14
3A	500		0.68	17
2A	400		0.90	23
1A	320	Fine: For finishing, valve lapping bearings, dies and gauges	1.28	33
A	280		1.75	44
B	240	Medium Fine: For cylinder lapping	2.48	63
C	220		2.60	66
D	180	Medium: General purpose for controlled metal removal	3.40	86
NC	150		4.80	122
E	120	Coarse: For the initial "cut," fast removal of metal	5.60	142
F	100		6.80	173
G	80		15.00	267
J	54	Very Coarse: For fastest metal removal	18.00	463

Loctite® Adhesives and Sealants Product Specialists are available to assist you. For application assistance, call **1-800-LOCTITE (562-8483)**; *within Canada, call 1-800-263-5043*; or, contact us through the web at www.henkelna.com/loctite.

STRAIGHT FROM *The Source*

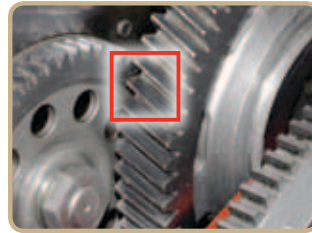

Your Source **MACHINING COMPOUNDS GUIDE**

WHAT TYPE OF HONING IS NEEDED?

Mower Blade / Bed Knife Sharpening	Very Coarse – Medium Grit	Fine – Extremely Fine Grit	
FAIRWAY MOWER MAINTENANCE	“INITIAL CUT” FAST REMOVAL OF METAL	CYLINDER LAPPING	FINE POLISHING AND LAPPING
Loctite® Clover® Silicon Carbide Reel Sharpening Grade F – 100 Grit <small>Item # 39715 25 lb. pail</small>	Loctite® Clover® Silicon Carbide Grade J – 54 Grit <small>Item # 39483 1 lb. can 39486 100 lb. drum</small>	Loctite® Clover® Silicon Carbide Grade C – 220 Grit <small>Item # 39426 1 lb. can 39428 25 lb. pail</small>	Loctite® Clover® Silicon Carbide Grade 2A – 400 Grit <small>Item # 39523 1 lb. can</small>
TEE AND GREEN MOWERS / TOURNAMENT BLADES	Loctite® Clover® Silicon Carbide Grade G – 80 Grit <small>Item # 39473 1 lb. can 39476 100 lb. drum</small>	Loctite® Clover® Silicon Carbide Grade B – 240 Grit <small>Item # 39413 1 lb. can</small>	Loctite® Clover® Silicon Carbide Grade 3A – 500 Grit <small>Item # 39536 1 lb. can</small>
Loctite® Clover® Silicon Carbide Reel Sharpening Grade E – 120 Grit <small>Item # 39711 25 lb. pail</small>	Loctite® Clover® Silicon Carbide Grade F – 100 Grit <small>Item # 39463 1 lb. can 39465 25 lb. pail 39466 100 lb. drum</small>	FINISHING, VALVE LAPPING, BEARINGS, DIES AND GAUGES	Loctite® Clover® Silicon Carbide Grade 4A – 600 Grit <small>Item # 39549 1 lb. can 39551 25 lb. pail</small>
Loctite® Clover® Silicon Carbide Reel Sharpening Grade D – 180 Grit <small>Item # 39712 25 lb. pail</small>	GENERAL PURPOSE FOR THE CONTROLLED REMOVAL OF METAL	Loctite® Clover® Silicon Carbide Grade A – 280 Grit <small>Item # 39401 1 lb. can 39404 100 lb. drum</small>	POLISHING AND PRECISION LAPPING
Loctite® Clover® Silicon Carbide Reel Sharpening Grade C – 220 Grit <small>Item # 39723 25 lb. pail</small>	Loctite® Clover® Silicon Carbide Grade E – 120 Grit <small>Item # 39452 1 lb. can 39455 100 lb. drum</small>	Loctite® Clover® Silicon Carbide Grade 1A – 320 Grit <small>Item # 39510 1 lb. can 39512 25 lb. pail</small>	Loctite® Clover® Silicon Carbide Grade 5A – 800 Grit <small>Item # 39561 1 lb. can</small>
			Loctite® Clover® Silicon Carbide Grade 6A – 1,000 Grit <small>Item # 39574 1 lb. can</small>
			Loctite® Clover® Silicon Carbide Grade 7A – 1,200 Grit <small>Item # 39587 1 lb. can 39589 25 lb. pail 39590 100 lb. drum</small>

HELPFUL HINTS

- Loctite® Clover® machining compounds can be removed using the same solvent in which they are carried.
- Loctite® Clover® grease mix products can be removed using a petroleum-based solvent: Loctite® ODC-Free Cleaner & Degreaser.
- Loctite® Clover® Silicon Carbide Pat Gel® Water Mix can be removed with water; once Loctite® Clover® products are removed, dry the area thoroughly and apply oil or grease to the metal to prevent corrosion.

Your Source for
MACHINING COMPOUNDS
ABRADING COMPOUNDS

Sources **REVEALED**

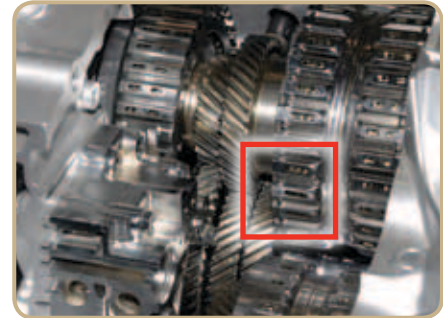

[Manufacturing Industries]

- Pumps
- Gearbox
- Valves

- Machining
- Sharpening
- Precision Fitting

INDUSTRIES

Loctite® Clover® Silicon Carbide Grease Mix

The standard abrasive paste for fast metal removal. Produces a smooth, flat surface but not a polished one. Leaves a rust-preventing film on lapped surfaces.

Item #	Grade A – 280 Grit	39401	1 lb. can
	Grade A – 280 Grit	39404	100 lb. drum
	Grade 1A – 320 Grit	39510	1 lb. can
	Grade 1A – 320 Grit	39512	25 lb. pail
	Grade 2A – 400 Grit	39523	1 lb. can
	Grade 3A – 500 Grit	39536	1 lb. can
	Grade 4A – 600 Grit	39549	1 lb. can
	Grade 4A – 600 Grit	39551	25 lb. pail
	Grade 5A – 800 Grit	39561	1 lb. can
	Grade 6A – 1,000 Grit	39574	1 lb. can
	Grade 7A – 1,200 Grit	39587	1 lb. can
	Grade 7A – 1,200 Grit	39589	25 lb. pail
	Grade 7A – 1,200 Grit	39590	100 lb. drum
	Grade B – 240 Grit	39413	1 lb. can
	Grade C – 220 Grit	39426	1 lb. can
	Grade C – 220 Grit	39428	25 lb. pail
	Grade D – 180 Grit	39439	1 lb. can
	Grade D – 180 Grit	39441	25 lb. pail
	Grade NC – 180 Grit	39499	1 lb. can
	Grade E – 120 Grit	39452	1 lb. can
	Grade E – 120 Grit	39455	100 lb. drum
	Grade F – 100 Grit	39463	1 lb. can
	Grade F – 100 Grit	39465	25 lb. pail
	Grade F – 100 Grit	39466	100 lb. drum
	Grade G – 80 Grit	39473	1 lb. can
	Grade G – 80 Grit	39476	100 lb. drum
	Grade J – 54 Grit	39483	1 lb. can
	Grade J – 54 Grit	39486	100 lb. drum

Loctite® Clover® Duplex Packaging Kit

CONTAINS CLOVER SILICON CARBIDE GREASE MIX GRADES E/A

Loctite® Clover® Silicon Carbide Grease Mix in two convenient grit sizes (120 and 280).

Item #	Grade E/A – 120/280 Grit	39598	Kit – 4 oz. duplex can
--------	--------------------------	-------	------------------------

Loctite® Clover® Silicon Carbide Reel Sharpening Mix

Water-soluble. This compound clings to blades for superior honing action but washes away for easy cleanup.

Item #	Grade C – 220 Grit	39723	25 lb. pail
	Grade D – 180 Grit	39712	25 lb. pail
	Grade E – 120 Grit	39711	25 lb. pail
	Grade F – 100 Grit	39715	25 lb. pail

Loctite® Clover® Silicon Carbide Pat Gel® Water Mix

Paste formulation for fast metal removal. Biodegradable, recommended for applications where cleanup with water is required.

Item #	Grade A – 280 Grit	39406	1 lb. jar
	Grade 1A – 320 Grit	39515	1 lb. jar
	Grade 2A – 400 Grit	39528	1 lb. jar
	Grade 3A – 500 Grit	39541	1 lb. jar
	Grade 3A – 500 Grit	39542	25 lb. pail
	Grade 4A – 600 Grit	39554	1 lb. jar
	Grade 5A – 800 Grit	39566	1 lb. jar
	Grade 6A – 1,000 Grit	39579	1 lb. jar
	Grade 7A – 1,200 Grit	39592	1 lb. jar
	Grade B – 240 Grit	39418	1 lb. jar
	Grade B – 240 Grit	39419*	25 lb. pail
	Grade C – 220 Grit	39431	1 lb. jar
	Grade D – 180 Grit	39444	1 lb. jar
	Grade NC – 150 Grit	39504	1 lb. jar
	Grade E – 120 Grit	39458*	25 lb. pail
	Grade E – 120 Grit	39457	1 lb. jar
	Grade F – 100 Grit	39468	1 lb. jar
	Grade G – 80 Grit	39478	1 lb. jar
	Grade G – 80 Grit	39479	25 lb. pail
	Grade J – 54 Grit	39488	1 lb. jar

* Made-to-order item.

[Loctite® Abrading Compounds Properties Chart]

PRODUCT	GRADE	GRIT	ITEM NUMBER	PACKAGE TYPE & SIZE
CLOVER® SILICON CARBIDE REEL SHARPENING MIX	C	220	39723	25 lb. pail
	D	180	39712	25 lb. pail
	E	120	39711	25 lb. pail
	F	100	39715	25 lb. pail
CLOVER® SILICON CARBIDE GREASE MIX	J	54	39483	1 lb. can
			39486	100 lb. drum
	G	80	39473	1 lb. can
			39476	100 lb. drum
	F	100	39463	1 lb. can
			39465	25 lb. pail
			39466	100 lb. drum
	E	120	39452	1 lb. can
			39455	100 lb. drum
	NC	150	39499	1 lb. can
	D	180	39439	1 lb. can
			39441	25 lb. pail
	C	220	39426	1 lb. can
			39428	25 lb. pail
	B	240	39413	1 lb. can
	A	280	39401	1 lb. can
			39404	100 lb. drum
	1A	320	39510	1 lb. can
			39512	25 lb. pail
	2A	400	39523	1 lb. can
	3A	500	39536	1 lb. can
	4A	600	39549	1 lb. can
			39551	25 lb. pail
	5A	800	39561	1 lb. can
	6A	1,000	39574	1 lb. can
	7A	1,200	39587	1 lb. can
			39589	25 lb. pail
			39590	100 lb. drum
E/A	120/280	39598	Kit – 4 oz. duplex can	
CLOVER® SILICON CARBIDE PAT GEL® WATER MIX	J	54	39488	1 lb. jar
	G	80	39478	1 lb. jar
			39479	25 lb. pail
	F	100	39468	1 lb. jar
	E	120	39457	1 lb. jar
			39458*	25 lb. pail
	NC	150	39504	1 lb. jar
	D	180	39444	1 lb. jar
	C	220	39431	1 lb. jar
	B	240	39418	1 lb. jar
			39419*	25 lb. pail
	A	280	39406	1 lb. jar
	1A	320	39515	1 lb. jar
	2A	400	39528	1 lb. jar
	3A	500	39541	1 lb. jar
39542			25 lb. pail	
4A	600	39554	1 lb. jar	
5A	800	39566	1 lb. jar	
6A	1,000	39579	1 lb. jar	
7A	1,200	39592	1 lb. jar	

* Made-to-order item.

Your Source for
POTTING & ENCAPSULATING

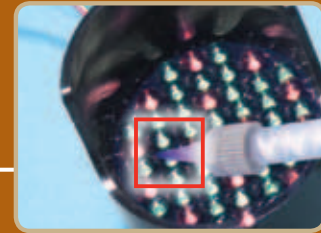
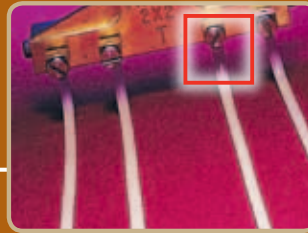

[Table of Contents]

POTTING & ENCAPSULATING	105
EPOXIES & POLYURETHANES	107
SILICONES	111
SILICONE EQUIPMENT	113
HOT MELTS	114
HOT MELTS EQUIPMENT	115

Potting and encapsulating compounds are used to provide mechanical reinforcement to housed assemblies, to fill large voids and to protect components from the effects of exposure to chemicals, moisture, mechanical shock and vibration. Sealing components with potting and encapsulating compounds prevents corrosion and ensures long-term integrity of the device.

VARIABLES TO CONSIDER WHEN SELECTING A POTTING OR ENCAPSULATING MATERIAL INCLUDE:

- Viscosity of uncured compound
- Dispensing requirements
- Device operating temperature
- Desired chemical resistance
- Desired thermal conductivity
- Desired flame retardance
- Hardness of cured product
- Overall cost

There are a variety of potting and encapsulating compounds to choose from – epoxy, hot melt, silicone and urethane. The thermal properties of epoxy and silicone systems make them ideally suited for applications exposed to temperatures above 257°F (125°C). If a soft, flexible material is needed, particularly at low temperatures, then a urethane, silicone or hot melt material may be used.

WHAT IS THE BEST PRODUCT FOR MY APPLICATION?

The following chart will work best when selecting a potting or encapsulating compound. This chart is intended to serve as a general guideline to help you determine which categories are best suited for your application. The data presented represents typical properties for each product category; however, individual product properties may differ. It is suggested that, based on the information provided, you consider at least the two best product categories that meet your application criteria. Individual product information can then be found on the pages that follow to help you narrow your search.

Loctite® Adhesives and Sealants Product Specialists are available to assist you with new product designs, or to help you re-engineer an existing application for improved performance and cost savings. They can also set up testing of your parts at the Henkel Customer Engineering Center. For application assistance, call **1-800-LOCTITE (562-8483)**; within Canada, call **1-800-263-5043**; or, contact us through the web at www.henkelna.com/loctite.

STRAIGHT FROM *The Source*

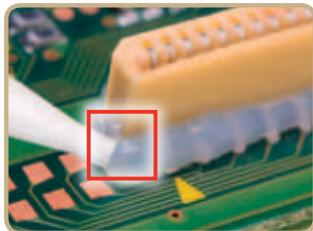

Your Source POTTING & ENCAPSULATING SELECTOR GUIDE

PERFORMANCE CONSIDERATIONS	POTTING & ENCAPSULATING COMPOUNDS			
	HOT MELTS	POLYURETHANES	EPOXIES	SILICONES
BENEFITS	Fast, large gap filling	Excellent toughness/flexibility	Wide range of formulations	Excellent temperature resistance
LIMITATIONS	Low heat resistance	Liquid adhesive sensitive to moisture	Mixing required	Low strength
TEMPERATURE RESISTANCE	-85°F to 257°F (-65°C to 125°C)	-85°F to 257°F (-65°C to 125°C)	-85°F to 356°F (-65°C to 180°C)	-85°F to 392°F (-65°C to 200°C)
FLUID RESISTANCE				
POLAR SOLVENTS¹	Good (Polyolefins, Polyamides)	Good	Very Good	Good
NON-POLAR SOLVENTS²	Good (Polyamides)	Good	Excellent	Poor
HARDNESS	Semisoft	Soft	Rigid	Soft
FLEXIBILITY	High	High	Low	Very High
GLASS TRANSITION TEMPERATURE (T_g)	Low	Low	High	Very Low
PERFORMANCE CONSIDERATIONS	POTTING & ENCAPSULATING COMPOUNDS			
	HOT MELTS	POLYURETHANES	EPOXIES	SILICONES
NUMBER OF COMPONENTS	1	2	2	1
CURE TEMPERATURE	Room Temperature (applied at elevated temperature)	Room Temperature	Room Temperature	UV/Room Temperature
GEL TIME				
AVERAGE	60 seconds	1 to 3 hours	1 to 3 hours	30 seconds
FASTEST	10 to 20 seconds	15 minutes	15 minutes	5 seconds
FULL CURE TIME	1 hour (or when cooled)	24 hours	24 hours	24 hours
DEPTH OF CURE	Unlimited	Unlimited	Unlimited	Shallow (<1.5 in.)
DISPENSING/CURING EQUIPMENT REQUIRED?	Yes	Yes	Yes	Yes
LIGHT CURE VERSIONS AVAILABLE?	No	No	Yes	Yes

¹ Examples of Polar Solvents: Water, Ethylene Glycol, Isopropyl Alcohol, Acetone.

² Examples of Non-Polar Solvents: Motor Oil, Gasoline, Toluene, n-Heptane, ATF.

PLEASE NOTE: This chart should not be used to specify products without specific testing. It is recommended that you conduct on-part testing to ensure product performance before specifying any adhesives.

Your Source for
**POTTING & ENCAPSULATING
 EPOXIES &
 POLYURETHANES**

- Provides tough, long-lasting anti-skid surfaces for added safety
- Can be easily applied using Loctite® phenolic or bristle rollers to concrete, metal or wood surfaces
- Stands up to heavy traffic and harsh environments
- For maximum adhesion, use Loctite® Big Foot® primers

[Epoxies & Polyurethanes]

Loctite® Hysol® potting and encapsulating compounds are two-part epoxy and polyurethane systems formulated to offer a wide range of performance characteristics matched to specific application requirements. Any epoxy resin can be combined with any epoxy hardener to create a mixed system. The same applies to the polyurethane resins and hardeners.

[Loctite® Hysol® Epoxy Kits Properties Chart]

LOCTITE® PRODUCT	ITEM NUMBER	PACKAGE TYPE & SIZE	COLOR	WORK LIFE	HARDNESS (SHORE)	AGENCY APPROVALS	KEY FEATURES
LOCTITE® HYSOL® EPOXY KITS	E-60NC™	29324 50 ml dual cartridge 29325 200 ml dual cartridge 29326 400 ml dual cartridge	Black	60 min.	85	CFIA	Electrically noncorrosive, low viscosity
	E-30CL™	29329 50 ml dual cartridge 29330 200 ml dual cartridge 29331 400 ml dual cartridge	Clear	30 min.	85	N/A	Medium fixture, chemical resistant
	E-40EXP™	1511184 50 ml dual cartridge 1511653 200 ml dual cartridge 1511896 5 gallon pail - part A 1511897 5 gallon pail - part B	Black	35 min.	80	UL 674	Chemical resistant, use in hazardous locations

**LOCTITE® DURAPUMP™
 METER MIX SYSTEMS**

Loctite® DuraPump™ Meter Mix Systems offer superior operating performance and durability for a wide range of two-component adhesive chemistries (including MMA**) up to 10:1 ratios and is available in two different models – programmable and pneumatic. For more product and technical information and other Loctite® Meter Mix systems, please go to [page 181](#).



ADDITIONAL
 RESOURCES

* Made-to-order items. ** Pneumatic only

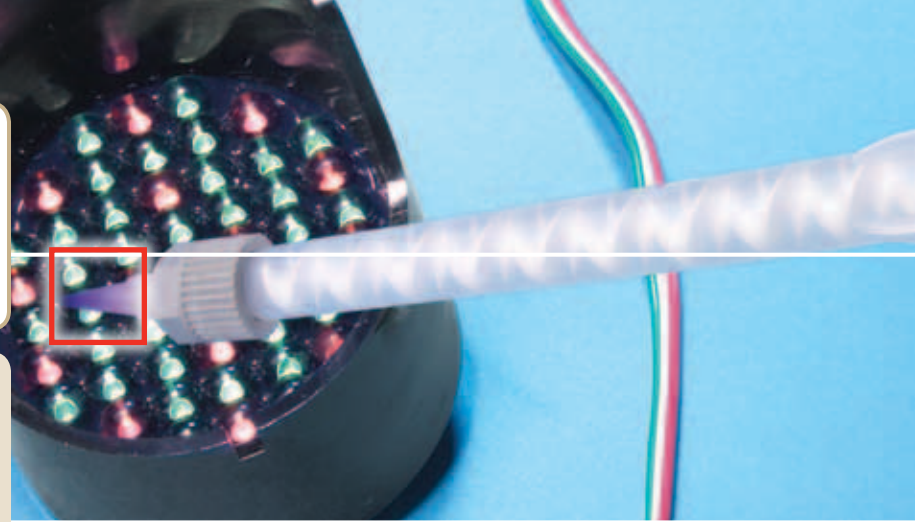

[Loctite® Hysol® Epoxies Product Chart]

LOCTITE® PRODUCT	ITEM NUMBER	PACKAGE TYPE & SIZE	PACKAGE WEIGHT	KEY FEATURES
LOCTITE® HYSOL® EPOXIES RESINS	3140™ 39944 39945*	1 gallon pail 5 gallon pail	12 lbs. 65 lb.	General-Purpose
	3141™ 39947 39948*	1 gallon pail 5 gallon pail	12 lbs. 63 lbs.	High Temperature
	3142™ 39950	1 gallon pail	16 lbs.	Thermally Conductive
	3145™ 40512 40511*	1 gallon pail 5 gallon pail	13 lbs. 65 lbs.	Flame Retardant
LOCTITE® HYSOL® EPOXIES HARDENERS	3160™ 39958*	5 gallon pail	40 lbs.	Glossy Surface Finish
	3162™ 39960 39962*	1 quart can 5 gallon pail	1.8 lbs. 36 lbs.	Fast Cure
	3163™ 39964 39966*	1 quart can 5 gallon pail	1.7 lbs. 38 lbs.	Excellent Adhesion
	3164™ 39969 39970*	1 gallon pail 5 gallon pail	7 lbs. 40 lbs.	General-Purpose
	3165™ 39395	1 quart can	1.7 lbs.	Low Shrinkage

[Loctite® Hysol® Polyurethanes Product Chart]

LOCTITE® PRODUCT	ITEM NUMBER	PACKAGE TYPE & SIZE	PACKAGE WEIGHT	KEY FEATURES
LOCTITE® HYSOL® POLYURETHANES RESINS	3173™ 39984 39985 39986*	1 quart can 1 gallon pail 5 gallon pail	2.5 lbs. 10 lbs. 50 lbs.	General-Purpose
	3182™ 39995 39996* 39997*	1 gallon pail 5 gallon pail 55 gallon drum	12 lbs. 62 lbs. 625 lbs.	Fast Cure
LOCTITE® HYSOL® POLYURETHANES HARDENERS	3183™ 39998 39999*	1 gallon pail 5 gallon pail	7.5 lbs. 37 lbs.	General-Purpose
	3184™ 39398 39397*	1 gallon pail 5 gallon pail	12 lbs. 625 lbs.	Flame Retardant

[Loctite® Hysol® Polyurethanes Kits Properties Chart]

LOCTITE® PRODUCT	ITEM NUMBER	PACKAGE TYPE & SIZE	COLOR	WORK LIFE	HARDNESS (SHORE)	AGENCY APPROVALS	KEY FEATURES
LOCTITE® HYSOL® POLYURETHANES KITS	3364™ NEW	1166733 50 ml dual cartridge	Black	45 sec.	85	UL 94V-0	Fast cure, 1:1 mix ratio, black

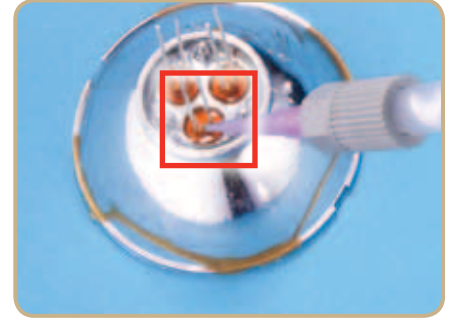
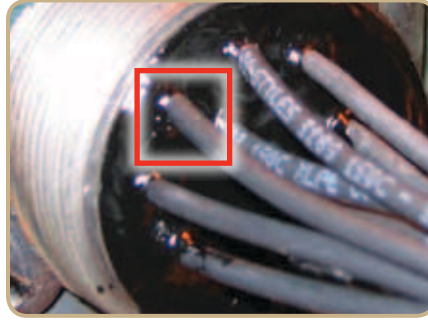
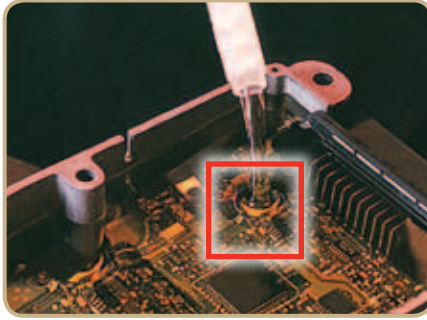

[Applications]

- Electronic Connectors and Assemblies
- Controls
- Lighting
- LED
- Power
- Solar
- Signs and Displays
- Wire and Cable

[Loctite® Hysol® Polyurethane Systems Properties Chart]

SYSTEM CHARACTERISTICS		LOCTITE® HYSOL® POLYURETHANE SYSTEMS			
		3173™/3182™	3173™/3183™	3173™/3184™	
TYPICAL UNCURED PROPERTIES	VISCOSITY (cP)	Resin	75	75	75
		Hardener	30,000	800	14,000
		Mixed	5,500	450	2,250
	WORKING TIME	At 73°F (23°C)	<7 minutes @ 300 g	20 to 40 minutes @ 105 g	150 minutes @ 300 g
	GEL TIME	At 73°F (23°C)	14 minutes @ 300 g	40 to 70 minutes @ 105 g	150 minutes @ 300 g
	CURE CYCLE	Normal 73°F (23°C)	90 minutes	24 hours	24 hours
		Alternate 185°F (85°C)	30 minutes	1 to 3 hours	1 to 3 hours
MIX RATIO	By Weight (Resin : Hardener)	13:87	30:70	15:85	
	By Volume (Resin : Hardener)	1:5.2	1:3	1:4.8	
COLOR	Resin	Dark Brown	Clear Brown	Clear Brown	
	Hardener	Black	Opaque Black	Opaque White	
	Mixed	Black	Opaque Black	Opaque White	
SPECIFIC GRAVITY	Resin	1.23	1.23	1.23	
	Hardener	1.60	0.96	1.45	
	Mixed	1.55	1.06	1.40	
TYPICAL CURED PROPERTIES	HARDNESS, SHORE A	75	70	80	
	HARDNESS, SHORE 00	N/A	N/A	N/A	
	GLASS TRANSITION TEMPERATURE/T _g (°C)	-10	-16	-15	
	CTE ABOVE T _g (M/MM°C)	128x10e-6	190x10e-6	151x10e-6	
TYPICAL CURED PROPERTIES	DIELECTRIC CONSTANT	0.1 kHz	4.68	5.92	4.51
		1.0 kHz	4.02	4.36	4.29
		10.0 kHz	3.76	3.65	3.94
		100.0 kHz	3.63	3.31	3.56
	DISSIPATION FACTOR	0.1 kHz	0.13	0.22	0.02
		1.00 kHz	0.07	0.17	0.04
		10.0 kHz	0.04	0.10	0.06
		100.0 kHz	0.02	0.05	0.07
	INSULATION RESISTANCE (OHMS)	2.5x10e+13	1.1x10e+11	1.1x10e+12	
	VOLUME RESISTIVITY (OHMS/CM)	1.5x10e+15	6.83x10e+12	6.61x10e+13	
DIELECTRIC STRENGTH (VOLTS/MIL)	370	375	370		
FLAMMABILITY RATING	N/A	N/A	94V-0 @ 3/8 in.		
UL FILE NO. E257711	N/A	N/A	94V-2 @ 1/4 in.		

Your Source for
**POTTING & ENCAPSULATING
 EPOXIES &
 POLYURETHANES**

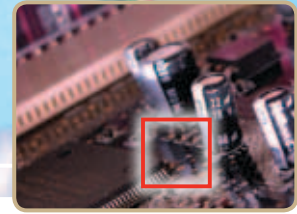
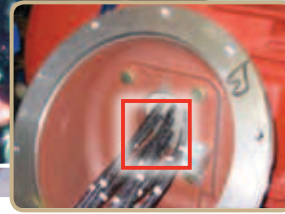

SYSTEM CHARACTERISTICS			LOCTITE® 3140™ HYSOL® EPOXY SYSTEM					LOCTITE® 3141™ HYSOL® EPOXY SYSTEM				
			3140™/3160™	3140™/3162™	3140™/3163™	3140™/3164™	3140™/3165™	3141™/3160™	3141™/3162™	3141™/3163™	3141™/3164™	3141™/3165™
TYPICAL UNCURED PROPERTIES	VISCOSITY (cP)	Resin	11,000	11,000	11,000	11,000	11,000	80,000	80,000	80,000	80,000	80,000
		Hardener	180	120	450	105	55	180	120	450	105	55
		Mixed	1,700	2,000	1,500	1,500	2,000	7,000	5,000	4,000	6,000	13,000
	WORKING TIME	73°F (25°C)	80 to 100 min. @ 200 g	5 to 10 min. @ 100 g	80 to 100 min. @ 200 g	10 to 15 min. @ 400 g	to 1.5 hrs. @ 400 g	1.5 to 2 hrs. @ 400 g	5 min. @ 200 g	30 to 45 min. @ 200 g	10 min. @ 400 g	35 to 40 min. @ 200 g
	GEL TIME	73°F (25°C)	2.5 to 3 hrs. @ 200 g	10 to 15 min. @ 105 g	2.5 to 3 hrs. @ 200 g	25 to 35 min. @ 400 g	2 to 3 hrs. @ 400 g	2.5 to 3.5 hrs. @ 400 g	10 to 15 min. @ 200 g	60 to 80 min. @ 200 g	20 to 25 min. @ 200 g	65 to 75 min. @ 200 g
	CURE CYCLE	Normal 73°F (25°C)	24 hrs.	16 hrs.	24 hrs.	16 hrs.	24 hrs. @ 77°F + 4 hrs. @ 200°F	24 hrs.	24 hrs.	24 hrs.	24 hrs.	24 hrs. @ 77°F + 4 hrs. @ 200°F
		Alternate 150°F (60°C)	2 hrs.	1 hr.	2 hrs.	2 hrs.	N/A	4 hrs.	2 hrs.	2 hrs.	2 hrs.	N/A
	MIX RATIO	By Weight (R:H)	100:20	100:18.1	100:29	100:29.5	100:9	4:1	100:19.8	100:30	100:31.5	100:9
		By Volume (R:H)	3.1:1	3.6:1	2:1	2:1	6.5:1	2.5:1	3:1	2:1	2:1	6.5:1
	COLOR	Resin	Black	Black	Black	Black	Black	Black	Black	Black	Black	Black
Hardener		Clear	Clear	Clear	Clear	Clear	Clear	Clear	Amber	Amber	Clear	
Mixed		Black	Black	Black	Black	Black	Black	Black	Black	Black	Black	
SPECIFIC GRAVITY	Resin	1.64	1.64	1.64	1.64	1.64	1.61	1.61	1.61	1.61	1.61	
	Hardener	1.00	0.99	0.96	0.97	0.96	1.00	0.99	0.96	0.97	0.96	
	Mixed	1.48	1.48	1.41	1.42	0.96	1.44	1.46	1.40	1.40	1.40	
TYPICAL CURED PROPERTIES	HARDNESS, SHORE D		80	80	80	70	85	85	90	80	85	85
	GLASS TRANSITION TEMPERATURE/Tg (°C)		27	35	20	27	67	43	75	38	31	104
	CTE ABOVE Tg (MM/MM°C)		130x10e-6	125x10e-6	133x10e-6	150x10e-6	119x10e-6	160x10e-6	135x10e-6	138x10e-6	111x10e-6	115x10e-5
	CTE BELOW Tg (MM/MM°C)		44x10e-6	37.5x10e-6	44.9x10e-6	82.6x10e-6	36.0x10e-6	60.7x10e-6	39.7x10e-6	52.6x10e-6	49.2x10e-6	35x10e-6
	DIELECTRIC CONSTANT	0.1 kHz	4.43	4.25	4.61	4.2	4.87	4.30	3.91	3.58	4.11	4.28
		1.0 kHz	4.37	4.20	4.37	4	4.83	4.22	3.88	3.52	3.97	4.18
		10.0 kHz	4.31	4.16	4.20	3.8	4.75	4.14	3.84	3.46	3.87	4.06
		100.0 kHz	4.24	4.10	4.05	3.7	4.64	4.03	3.79	3.39	3.77	3.92
	DISSIPATION FACTOR	0.1 kHz	0.008	0.010	0.040	0.08	0.003	0.01	0.01	0.01	0.02	0.01
		1.0 kHz	0.008	0.011	0.027	0.04	0.007	0.01	0.01	0.01	0.02	0.02
10.0 kHz		0.010	0.012	0.026	0.03	0.011	0.02	0.01	0.01	0.02	0.02	
100.0 kHz		0.014	0.013	0.023	0.03	0.014	0.02	0.01	0.02	0.02	0.02	
INSULATION RESISTANCE (OHMS)		1.14x10e+13	2.67x10e+13	1.61x10e+12	7.5x10e+111	5.19x10e+13	5.72x10e+13	4.09x10e+13	1.23x10e+14	4.57x10e+13	2.15x10e+13	
VOLUME RESISTIVITY (OHMS/CM)		6.03x10e+14	2.53x10e+15	1.02x10e+14	1.5x10e+14	2.69x10e+15	4.03x10e+15	2.61x10e+15	7.41x10e+15	2.98x10e+15	1.37x10e+15	
DIELECTRIC STRENGTH (VOLTS/MIL)		365	385	365	410	355	375	355	385	395	365	
FLAMMABILITY RATING UL FILE NO. E257711		N/A	N/A	N/A	UL 94B @ 1/16 in.	N/A	N/A	N/A	N/A	N/A	N/A	
INSULATION SYSTEM UL FILE NO. E257711		N/A	N/A	N/A	UL 1446	N/A	N/A	N/A	N/A	N/A	N/A	

SYSTEM CHARACTERISTICS		LOCTITE® 3142™ HYSOL® EPOXY SYSTEM					LOCTITE® 3145™ HYSOL® EPOXY SYSTEM					
		3142™/3160™	3142™/3162™	3142™/3163™	3142™/3164™	3142™/3165™	3145™/3160™	3145™/3162™	3145™/3163™	3145™/3164™	3145™/3165™	
TYPICAL UNCURED PROPERTIES	VISCOSITY (cP)	Resin	120,000 - 200,000	120,000 - 200,000	120,000 - 200,000	120,000 - 200,000	120,000 - 200,000	32,760	32,760	32,760	32,760	32,760
		Hardener	180	120	450	105	55	180	120	450	105	55
		Mixed	7,500	6,000	7,000	8,000	18,000	5,560	7,150	5,315	5,790	13,355
	WORKING TIME	77°F (25°C)	1.5 to 2 hrs. @ 400 g	5 to 10 min. @ 200 g	2 hrs. @ 400 g	25 min. @ 400 g	80 min. @ 400 g	2.5 to 4 hrs. @ 200 g	15 to 30 min. @ 200 g	3 to 3.5 hrs. @ 200 g	35 to 45 min. @ 200 g	2.5 to 3 hrs. @ 400 g
	GEL TIME	77°F (25°C)	3.5 to 4 hrs. @ 400 g	5 to 30 min. @ 200 g	>3 hrs. @ 400 g	50 min. @ 400 g	2.5 hrs. @ 400 g	6 to 8 hrs. @ 200 g	35 to 45 min. @ 200 g	6 to 7 hrs @ 200 g	75 to 90 min. @ 200 g	5 hrs. @ 200 g
	CURE CYCLE	Normal 77°F (25°C)	24 hrs.	24 hrs.	48 hrs.	24 hrs.	24 hrs. @ 77°F + 4 hrs. @ 200°F	24 hrs.	24 hrs.	24 hrs.	24 hrs.	24 hrs. @ 77°F + 4 hrs. @ 200°F
		Alternate 150°F (66°C)	4 hrs.	2 hrs.	4 hrs.	2 hrs.	4 hrs. @ + 200°F	2 hrs.	2 hrs.	4 hrs.	2 hrs.	4 hrs. @ + 200°F
	MIX RATIO	By Weight (R:H)	100:10.7	100:9	100:10.9	100:14.3	100:4.1	100:15	100:13	100:15.5	100:20	100:6
		By Volume (R:H)	3.8:1	4.5:1	3.6:1	2.8:1	9.7:1	4:1	4.5:1	3.7:1	2.9:1	9.7:1
	COLOR	Resin	Black	Black	Black	Black	Black	Black	Black	Black	Black	Black
Hardener		Clear	Clear	Amber	Amber	Clear	Clear	Clear	Clear	Clear	Clear	
Mixed		Black	Black	Black	Black	Black	Black	Black	Black	Black	Black	
SPECIFIC GRAVITY	Resin	2.40	2.40	2.40	2.40	2.40	1.67	1.67	1.67	1.67	1.67	
	Hardener	1.00	0.99	0.96	0.97	0.96	1.00	0.99	0.96	0.97	0.96	
	Mixed	1.54	1.54	1.53	1.50	1.62	1.51	1.54	1.49	1.49	1.58	
TYPICAL CURED PROPERTIES	HARDNESS, SHORE D		90	90	90	85	90	80	84	80	75	88
	GLASS TRANSITION TEMPERATURE/Tg (C°)		26	42	30	29	84	28	42	38	32	53
	CTE ABOVE Tg (MM/MM°C)		104x10e-6	97.2x10e-6	96.1x10e-6	106x10e-6	87.7x10e-6	1.22x10e-6	128x10e-6	130x10e-6	122x10e-6	111x10e-6
	CTE BELOW Tg (MM/MM°C)		29.2x10e-6	28.2x10e-6	33.5x10e-6	51.9x10e-6	26.9x10e-6	39.2x10e-6	42.6x10e-6	49.0x10e-6	59.4x10e-6	40.6x10e-6
	THERMAL CONDUCTIVITY	Watts/Meter°C	0.422	1.40	1.40	1.27	1.14	0.7935	0.8068	0.8119	0.7324	1.0341
		DIELECTRIC CONSTANT	0.1 kHz	5.77	4.87	5.28	5.51	5.65	4.08	3.81	4.27	4.19
	1.0 kHz		5.69	4.83	5.20	5.35	5.57	4.28	3.85	4.36	4.46	4.45
	10.0 kHz		5.62	4.78	5.12	5.21	5.46	4.15	3.74	4.11	4.22	4.28
	100.0 kHz		5.52	4.72	5.02	5.06	5.34	4	3.63	3.90	3.99	4.11
	DISSIPATION FACTOR	0.1 kHz	0.00	0.01	0.01	0.02	0.01	0.027	0.028	0.033	0.036	0.045
1.0 kHz		0.001	0.01	0.01	0.02	0.01	0.031	0.025	0.046	0.042	0.036	
10.0 kHz		0.01	0.01	0.01	0.02	0.01	0.025	0.021	0.037	0.037	0.027	
100.0 kHz		0.01	0.01	0.01	0.02	0.01	0.023	0.017	0.031	0.034	0.024	
INSULATION RESISTANCE (OHMS)		4.61x10e+13	5.31x10e+13	3.65x10e+13	2.75x10e+12	4.09x10e+13	N/A	N/A	N/A	N/A	N/A	
VOLUME RESISTIVITY (OHMS/CM)		3.00x10e+15	3.47x10e+15	2.55x10e+15	1.65x10e+14	2.61x10e+15	1.10e+14	8.4e+14	2.1e+14	2.5e+13	7.3e+14	
DIELECTRIC STRENGTH (VOLTS/MIL)		360	345	355	345	335	595	693	748	695	794	
FLAMMABILITY RATING UL FILE NO. E257711		N/A	N/A	N/A	N/A	N/A	N/A	UL 94V-0 @ 1/8 in.	N/A	N/A	UL 94V-0 @ 1/8 in.	

Your Source for
**POTTING & ENCAPSULATING
 SILICONES**

- Single-component, tough, protective
- Seals components against moisture, solvents and environmental conditions
- Cures in as little as 30 seconds to depths of 0.150 in. when exposed to UV light or visible light

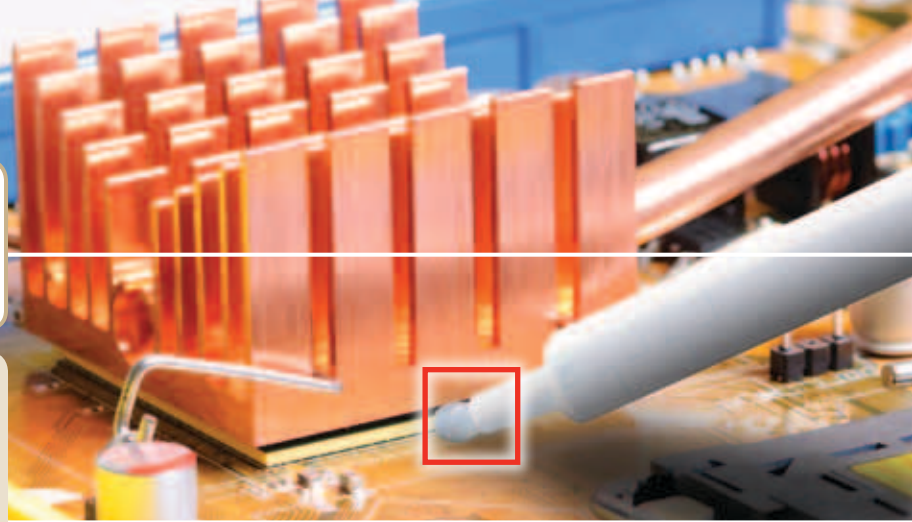

[Silicone Potting Compounds]

**Loctite® 5031™ Nuva-Sil®
 Silicone Potting Compound**

HIGH ADHESION/VISIBLE LIGHT

A low viscosity, self-leveling, UV or visible light curing silicone for high speed deep potting, coating and sealing applications. Provides high adhesion for difficult-to-bond substrates.

Item #	40086	300 ml cartridge
	40087	40 lb. pail

**Loctite® 5040™ RTV
 Silicone Potting Compound**

A noncorrosive, self-leveling RTV silicone for shallow potting, sealing and coating of devices, especially for military and industrial applications.

Item #	40405	85 g tube
	40404	300 ml cartridge

**Loctite® 5055™ Silicone
 Adhesive Sealant**

SELF-LEVELING/FLOWABLE

A UV or visible light curing, noncorrosive silicone for high speed coating, potting adhesion, or sealing applications. High adhesion for difficult-to-bond substrates.

Item #	1212167	25 ml syringe
	1214246	1 liter bottle
	1214247	15 liter pail*

**Loctite® 5056™ Silicone
 Adhesive Sealant**

**SELF-LEVELING/
 HIGH ADHESION**

A UV or visible light curing, noncorrosive silicone with very high bond strength. Ideal for high speed adhesion and sealing applications. High adhesion for difficult-to-bond substrates.

Item #	1214249	25 ml syringe
	1214250	1 liter bottle
	1214248	15 liter pail*

**Loctite® 5240™ Nuva-Sil®
 Medical Device Sealant**

**SELF-LEVELING/
 NONCORROSIVE**

A UV or visible light and moisture curing, noncorrosive silicone ideal for high speed adhesion and sealing applications. High adhesion for difficult-to-bond substrates.

Item #	1010341	30 ml syringe
	1010320	300 ml cartridge
	1010343	40 lb. pail

**Loctite® 5620™ Silicone
 Potting Compound**

ULTRA-CLEAR/FAST CURE

Two-part, ultra-clear, fast cure, noncorrosive silicone. Transparent in color. Ideal for sealant, or potting applications that require a transparent silicone. Fast room temperature cure.

Item #	1257593	50 ml dual cartridge
	1257478	400 ml dual cartridge
	1257595	Part A - 40 lb. pail
	1257597	Part B - 40 lb. pail
	1257594	Part A - 400 lb. drum
	1257596	Part B - 400 lb. drum

**Loctite® 5623™ Silicone
 Potting Compound**

ULTRA-CLEAR/TACK-FREE

Two-part, ultra-clear, tack-free, noncorrosive silicone gel. Transparent in color. Tough gel. Room temperature cure or accelerated heat cure.

Item #	1259300	400 ml dual cartridge
	1257611	Part A - 40 lb. pail
	1257607	Part B - 40 lb. pail
	1257612	Part A - 400 lb. drum
	1257609	Part B - 400 lb. drum

**Loctite® 5625™ Silicone
 Potting Compound**

ULTRA-CLEAR/SOFT GEL

Two-part, ultra-clear, soft, noncorrosive silicone gel. Transparent in color. Very soft, re-enterable gel. Room temperature cure or accelerated heat cure.

Item #	1257475	400 ml dual cartridge
	1257616	Part A - 40 lb. pail
	1257613	Part B - 40 lb. pail
	1257617	Part A - 400 lb. drum
	1257615	Part B - 400 lb. drum

**Loctite® 5611F™/5611S™
 Silicone Potting Compound**

**SELF LEVELING, NONCORROSIVE,
 FLAME RETARDANT**

Two-part, flame retardant (UL 94V-0) silicone. Products vary in cure speed and open times from fast (F) to standard (S) to match particular end-use applications. Grey in color.

Item #	1385991 - 5611F	490 ml dual cartridge
	1387908 - 5611 Part A	4.5 gallon pail
	1387706 - 5611F Part B	4.5 gallon pail
	1386373 - 5611 Part A	575 lb. drum
	1432213 - 5611F Part B	440 lb. drum
	1386378 - 5611S	490 ml dual cartridge
	1387908 - 5611 Part A	4.5 gallon pail
	1388496 - 5611S Part B	4.5 gallon pail
	1386373 - 5611 Part A	575 lb. drum
	1387212 - 5611S Part B	440 lb. drum

* Made-to-order item.

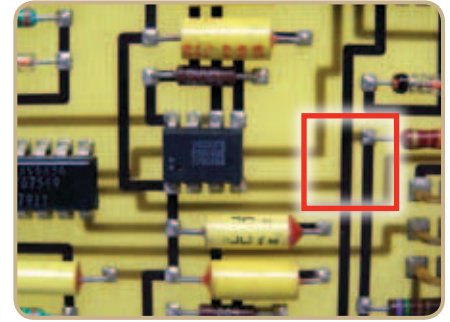
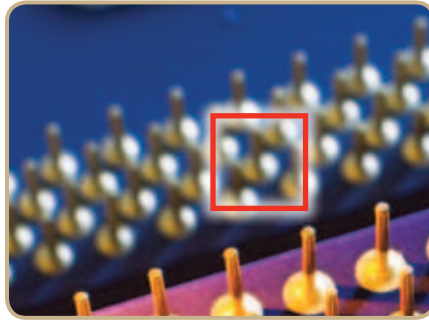
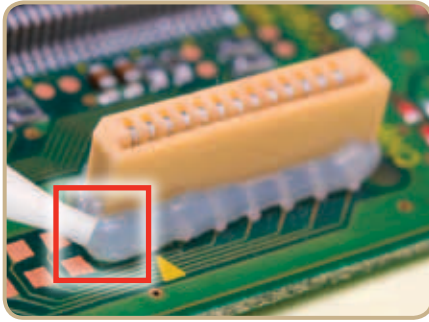

[Loctite® Silicone Potting Compounds Properties Chart]

LOCTITE® PRODUCT	ITEM NUMBER	PACKAGE TYPE & SIZE	CURE SCHEDULE (Cure/Air. Cure)	VISCOSITY (cP)	GEL TIME	HARDNESS	AGENCY APPROVALS
5031™ NUVA-SIL®	40086 40087	300 ml cartridge 40 lb. pail	UV/visible light/moisture 60 seconds @ 40 mW/cm ²	5,500	Seconds	34 Shore A	N/A
5040™	40405 40404	85 g tube 300 ml cartridge	Moisture 24 hours @ 77°F (25°C)	35,000	<3 hours (skin over)	30 Shore A	MIL-A-46146B
5055™	1212167 1214246 1214247**	25 ml syringe 1 liter bottle 15 liter pail	60 seconds @ 70 mW/cm ²	525	Seconds	55 Shore A	ISO® 10993 Compliant
5056™	1214249 1214250 1214248**	25 ml syringe 1 liter bottle 15 liter pail	60 seconds @ 70 mW/cm ²	2,200	Seconds	43 Shore A	ISO® 10993 Compliant
5091™ NUVA-SIL®	17412 18074	300 ml cartridge 40 lb. pail	UV/moisture 60 seconds @ 40 mW/cm ²	5,500	Seconds	34 Shore A	UL Classified for U.S.
5240™ NUVA-SIL®	1010341 1010320 1010343	30 ml syringe 300 ml cartridge 40 lb. pail	60 seconds @ 70 mW/cm ²	18,000	Seconds	45 Shore A	ISO® 10993 Compliant
5611F™	1385991 1387908 - Part A 1387706 - Part B 1386373 - Part A 1432213 - Part B	490 ml dual cartridge 4.5 gallon pail 4.5 gallon pail 575 lb. drum 440 lb. drum	Two-Part 10:1 A:B by volume 11 minutes tack free	Part A - 5,000 Part B - 5,000	19 minutes	55 Shore A	UL 94V-0
5611S™	1386378 1387908 - Part A 1388496 - Part B 1386373 - Part A 1387212 - Part B	490 ml dual cartridge 4.5 gallon pail 4.5 gallon pail 575 lb. drum 440 lb. drum	Two-Part 10:1 A:B by volume 38 minutes tack free	Part A - 5,000 Part B - 5,000	73 minutes	55 Shore A	UL 94V-0
5620™	1257593 1257478 1257595 1257597 1257594 1257596	50 ml dual cartridge 400 ml dual cartridge Part A - 40 lb. pail Part B - 40 lb. pail Part A - 400 lb. drum Part B - 400 lb. drum	Two-Part 30 minutes @ 77°F (25°C)	A: 220 B: 190 Mixed: 200	20 minutes*	35 Shore A	N/A
5623™	1259300 1257611 1257607 1257612 1257609	400 ml dual cartridge Part A - 40 lb. pail Part B - 40 lb. pail Part A - 400 lb. drum Part B - 400 lb. drum	Two-Part 1 hour @ 212°F (100°C) 24 hours @ 77°F (25°C)	A: 700 B: 700 Mixed: 700	120 minutes*	40 Shore 00	N/A
5625™	1257475 1257616 1257613 1257617 1257615	400 ml dual cartridge Part A - 40 lb. pail Part B - 40 lb. pail Part A - 400 lb. drum Part B - 400 lb. drum	Two-Part 1 hour at @ 12°F (100°C) 24 hours @ 77°F (25°C)	A: 1,000 B: 2,000 Mixed: 1,500	100 minutes*	2 Shore 00	N/A

ITEMS IN RED = Source's PICK or NEW





* Pot Life ** Made-to-order item.



Your Source for
**POTTING & ENCAPSULATING
 SILICONE EQUIPMENT**

YOUR EQUIPMENT Source

For more details, see the **Loctite® Equipment Sourcebook, LT-3669**, or visit us on the web for additional information, diagrams, products and our full line of equipment at www.equipment.loctite.com.



LOCTITE® PRODUCT		ITEM NUMBER	PRESSURE REGULATION	USED TO DISPENSE	PACKAGE TYPE & SIZES	VISCOSITY RANGE	LOW LEVEL SENSING	CONSUMABLES – DISPENSE ACCESSORIES	
DISPENSE SYSTEMS	PNEUMATIC CARTRIDGE DISPENSING								
		300 ML PNEUMATIC CARTRIDGE DISPENSING RETAINER	98319A	0 to 60 psi	Gel Cyanoacrylates, Anaerobic Gasketing, Light Cure/Acrylics, Silicones	300 ml cartridges	Low to Medium	Pneumatic	Cartridge Accessories – Page 183
		PNEUMATIC HANDHELD 300 ML DISPENSER	1294304	0 to 100 psi	Gel Cyanoacrylates, Anaerobic Gasketing, Light Cure/Acrylics, Silicones	300 ml cartridges 250 ml tubes	Medium to High	No	
		300 ML CARTRIDGE PUSHER	98022	0 to 50 psi	Gel Cyanoacrylates, Anaerobic Gasketing, Light Cure/Acrylics, Low Viscosity Silicones	300 ml cartridges 250 ml tubes	Medium	Yes	
	HIGH PRESSURE 300 ML BENCHTOP CARTRIDGE DISPENSER	1046901	0 to 725 psi	Silicone, Polyurethane, MS Polymer Adhesives	300 ml cartridges	10,000 to 1,000,000	Yes	Use with High Pressure Dispense Valve (sold separately) – see below	

LOCTITE® PRODUCT		ITEM NUMBER	TYPE	VISCOSITY RANGE	DISPENSE PATTERNS	USED TO DISPENSE	STROKE ADJUSTMENT	SUCK-BACK	CONSUMABLES – DISPENSE ACCESSORIES
VALVES & PUMPS	HIGH VISCOSITY FLUID AND PASTE VALVES								
		HIGH PRESSURE DISPENSE VALVE – 50 BAR	1049138	High Viscosity Fluid and Paste Valves	10,000 - 1,000,000 cP	Drop, Bead	Silicones, MS Polymers, Urethanes	Yes	Yes
	HIGH PRESSURE DISPENSE VALVE – 150 BAR	1153502	500,000 - 2,000,000 cP		Yes			No	

ITEMS IN RED = Source's PICK or NEW

LOCTITE® BRANDED EQUIPMENT – Loctite® is a full service supplier of equipment and offers a wide variety of equipment services to its customers. **For more Loctite® branded equipment, go to page 171.**

Can't find what you're looking for? Visit www.equipment.loctite.com or call 1-800-LOCTITE (562-8483).

STRAIGHT FROM The Source

Your Source for POTTING & ENCAPSULATING HOT MELTS

- Well-suited for fast, deep potting applications requiring large gap fills in high speed manufacturing environments
- Used for potting and encapsulating in the electronics industry

[Hot Melt Adhesives]

Loctite® 1942™ Hysol® Hot Melt Adhesive

GENERAL-PURPOSE

Medium setting, general-purpose hot melt adhesive. Excellent adhesion to wood and many plastics. Not recommended for high temperature potting applications.

- | | | |
|--------|-------|---------------------------------|
| Item # | 83266 | 5 lb. sample bag pellets |
| | 83267 | 40 lb. carton pellets |
| | 83269 | Maxistick 35 lb. carton |
| | 83271 | PT™ stick 36 lb. carton |
| | 83272 | Ministick 35 lb. carton |
| | 83273 | 5 oz. sample bag |
| | 83274 | Superstick 10 in. 25 lb. carton |
| | 83275 | Superstick 4 in. 25 lb. carton |
| | 83276 | 12 oz. sample bag |
| | 83277 | Polyshot 35 lb. carton |

Loctite® 7809FR™ Hysol® Hot Melt Adhesive

FIRE RETARDANT

Modified with fire retardant materials. It has a UL 94V-0 flammability rating.

- | | | |
|--------|-------|---------------------------------|
| Item # | 83390 | Superstick 10 in. 13 oz. bag |
| | 83675 | Superstick 10 in. 32 lb. carton |
| | 83676 | Polyshot 25 lb. pail |

Loctite® 7811™ Hysol® Hot Melt Adhesive

HIGH TEMPERATURE

A high performance polyamide with exceptional high temperature- and impact-resistance at low temperatures.

- | | | |
|--------|-------|----------------------------|
| Item # | 83337 | 5 lb. sample bag pellets |
| | 83339 | Polyshot 13 oz. sample bag |
| | 83340 | Polyshot 25 lb. pail |
| | 83338 | 40 lb. carton pellets |

Loctite® 7901™ Hysol® Hot Melt Adhesive

POLYAMIDE

Low viscosity polyamide used extensively for potting and encapsulating.

- | | | |
|--------|-------|-----------------------|
| Item # | 83342 | 40 lb. carton pellets |
| | 83344 | Polyshot 25 lb. pail |

[Loctite® Hysol® Hot Melt Adhesives Properties Chart]

LOCTITE® PRODUCT	ITEM NUMBER	PACKAGE TYPE & SIZE	COLOR	VISCOSITY (cP) AT DISPENSE TEMPERATURE	TENSILE STRENGTH (psi)	OPEN TIME	TEMPERATURE RESISTANCE	% ELONGATION	HARDNESS (SHORE A)	AGENCY APPROVALS
LOCTITE® HYSOL® HOT MELT ADHESIVES	1942™ HYSOL®	83266	Tan	5,000	250	30 seconds	142°F	500	N/A	FDA CFR175.105
		83267								
		83269								
		83271								
		83272								
		83273								
		83274								
		83275								
		83276								
		83277								
7809FR™ HYSOL®	83390	Superstick 10 in. 13 oz. bag	Amber	7,000	363	35 seconds	240°F	373	85	UL Classified for U.S.
	83675									
	83676									
7811™ HYSOL®	83337	5 lb. sample bag pellets	Amber	6,400	400	35 seconds	266°F	1,200	N/A	N/A
	83339									
	83340									
	83338									
7901™ HYSOL®	83342	40 lb. carton pellets	Amber	750	260	35 seconds	300°F	80	84	N/A
	83344									

You can find more Loctite® Hot Melt Adhesives in the bonding section on pages 13-16. Please see pages 115-116 for Loctite® Hot Melts applicators and Bulk Hot Melt Systems.

ADDITIONAL RESOURCES

Your Source for
**POTTING & ENCAPSULATING
 HOT MELTS EQUIPMENT**

YOUR EQUIPMENT Source







For more details, see the **Loctite® Equipment Sourcebook, LT-3669**, or visit us on the web for additional information, diagrams, products and our full line of equipment at www.equipment.loctite.com.





















LOCTITE® PRODUCT		ITEM NUMBER	STICK DIAMETER	DISPENSE MELT RATE	DISPENSE POWER	DISPENSE TEMPERATURE	HOT MELT CHEMISTRY	HOT MELT NOZZLES AND ACCESSORIES
1/2-INCH SUPERSTICK DISPENSERS								
	HYSOL™ 050A	916282	1/2 in. Superstick Sticks	4 lbs./hr.	Manual	383°F (195°C)	EVA/Polyolefin	Hot Melt Nozzles and Accessories – Page 116
	HYSOL™ 050-HT	98545	1/2 in. Superstick Sticks	4 lbs./hr.	Manual	419°F (215°C)	Polyamide	
3/4-INCH MAXISTICK DISPENSERS								
	HYSOL™ 075	98033	3/4 in. Maxistick Sticks	9 lbs./hr.	Manual	360°F (182°C)	EVA	Hot Melt Nozzles and Accessories – Page 116
	HYSOL™ 075-LT	98034	3/4 in. Maxistick Sticks	5 lbs./hr.	Manual	250°F (121°C)	CoolMelt™	
1 3/4-INCH SPRAYPAC® & POLYSHOT DISPENSERS								
	HYSOL™ 175-AIR	98036	1 3/4 in. Polyshot Sticks	8 lbs./hr.	Pneumatic	383°F (195°C)	EVA/Polyolefin	Hot Melt Nozzles and Accessories – Page 116
	HYSOL™ 175-AIR-HT	98040	1 3/4 in. Polyshot Sticks	8 lbs./hr.	Pneumatic	419°F (215°C)	EVA/Polyolefin	
	HYSOL™ 175-SPRAY	98037	1 3/4 in. Polyshot Sticks	8 lbs./hr.	Pneumatic	356°F (180°C)	EVA/Polyolefin	
	HYSOL™ 175-SPRAY-HT	98041	1 3/4 in. Polyshot Sticks	8 lbs./hr.	Pneumatic	383°F (195°C)	Polyamide	
	HYSOL™ 175	98035	1 3/4 in. Polyshot Sticks	6.6 lbs./hr.	Manual	383°F (195°C) and 419°F (215°C)*	EVA/Polyolefin and Polyamide	
URETHANE DISPENSER								
	HYSOL™ REACTIVE URETHANE CARTRIDGE DISPENSER	98011	N/A	3 lbs./hr.	Air	250°F (121°C)	Reactive Urethane	Hot Melt Nozzles and Accessories – Page 116
HOT MELT BENCH MOUNT & CONTROLLER OPTIONS								
	HOT MELT BENCH MOUNT KIT	98042	N/A	N/A	N/A	N/A	EVA/Polyamide	Hot Melt Nozzles and Accessories – Page 116
	HOT MELT PNEUMATIC TIMER	98043						

* The Loctite® Hysol™ 175 Dispenser (manual electric) is supplied with both temperature modules.

* If used with Bulk-34 System additional cable, Item Number 1053256 is also required and sold separately.

LOCTITE® PRODUCT	ITEM NUMBER	DESCRIPTION	USED WITH
	988107 <i>(SINGLE PACK)</i>	Adapter/Check Valves for Nozzles	98544, 98545
	419115 <i>(SINGLE PACK)</i>		98030, 98031, 98032, 98035, 98036, 98040
	98687 <i>(5 PACK)</i>		916282
	ANZ023N01	Standard Nozzle Adapter with Check Valve and Jam Nut	98033, 98034
	988108 <i>(5 PACK)</i>	1-Hole Nozzle 0.08 in. diameter cone tip (5 pack)	98544, 98545
	985225 <i>(5 PACK)</i>		98030, 98031, 98032, 98033, 98034, 98035, 98036, 98040
	916050		916282
	985110	2-Hole Nozzle 0.06 in. diameter x 0.39 in. spacing	98030, 98031, 98032, 98033, 98034, 98035, 98036, 98040, 98544, 98545
	985111	3-Hole Nozzle 0.06 in. diameter x 0.20 in. spacing	98030, 98031, 98032, 98033, 98034, 98035, 98036, 98040, 98544, 98545
	985112	Diagonal Extension Nozzle Tip = 0.14 in. diameter x 1.23 in. long	98030, 98031, 98032, 98033, 98034, 98035, 98036, 98040, 98544, 98545
	985113	Needle Extension Nozzle Tip = 0.05 in. diameter x 1.32 in. long	98030, 98031, 98032, 98033, 98034, 98035, 98036, 98040, 98544, 98545
	985114	Spreader Extension Nozzle Tip = (0.09 in. x 0.25 in.) sq. x 1.32 in. long	98030, 98031, 98032, 98033, 98034, 98035, 98036, 98040, 98544, 98545
	985115	L-Nozzle 0.06 in. diameter x 0.85 in. offset	98033, 98034, 98035, 98036, 98040, 98544, 98545
	985116	T-Nozzle 0.06 in. diameter x 1.5 in. spacing	98033, 98034, 98035, 98036, 98040, 98544, 98545
	985122	Standard Medium Spray Nozzle 1.25 in. to 5 in. diameter pattern	98037, 98041
	985211	Narrow Spray Nozzle 0.05 in. to 1.25 in. diameter pattern	98037, 98041
	985216	Ultra-Wide Spray Nozzle 1.5 in. to 6.0 in. diameter pattern	98037, 98041

For custom hot melt dispense nozzles, contact the Special Equipment Group of Henkel at **1-800-LOCTITE (562-8483)**.

LOCTITE® PRODUCT	ITEM NUMBER	DESCRIPTION	USED WITH
	984999	Standard 1-Hole Nozzle with Integral Check Valve – Tip = 0.10 in. diameter x 0.16 in. long	98029
	985001	Spreader Nozzle with Integral Check Valve – Tip = (0.08 in. x 0.25 in.) sq. x 0.47 in. long	98029
	985002	Pencil Point Nozzle with Integral Check Valve – Tip = 0.08 in. diameter x 0.24 in. long	98029
	985003	Precision Nozzle with Integral Check Valve – Tip = 0.05 in. diameter x 0.20 in. long	98029
	985004	Extension Nozzle with Integral Check Valve – Tip = 0.10 in. diameter x 0.50 in. long	98029
	985005	Silicone Rubber Safety Cap (2 pack) (for use with 984999, 985002, 985004)	98029
	98012	Cartridge Pre-Heater Holds (2) 300 ml cartridges	98011
	984261	Standard Adapter for 300 ml Cartridges	98011
	984262	Standard 1-Hole Nozzle 0.098 in. diameter cone tip, with integral check valve (includes protective cap)	98011
	984263	Adapter/Check Valve for Specialty Nozzles	98011
	984264	Needle Jet Nozzle Tip = 0.051 in. diameter x 1.26 in. long (requires 984263 adapter)	98011
	984265	Diagonal Extension Nozzle Tip = 0.123 in. diameter x 1.276 in. long (requires 984263 adapter)	98011
	984267	2-Hole Nozzle 0.06 in. diameter x 0.39 in. spacing (requires 984263 adapter)	98011
	984268	3-Hole Nozzle 0.06 in. diameter x 0.20 in. spacing (requires 984263 adapter)	98011
	984272	Injection Needle Nozzle with Integral Check Valve Tip = 0.059 in. diameter x 0.197 in. long	98011
	985087	Heavy Duty Metal Stand for Benchtop or Wall Mounting	98030, 98031, 98032, 98035, 98036, 98037, 98040, 98041
	985243	Tool Hanger/Balancer – 0 to 1.5 kg	All Hot Melt Applicators
	985397	Air Line Filter, Regulator Gauge 0 to 150 psi	All Pneumatic Applicators

Your Source for
**REPAIRING,
REBUILDING
& RESTORING**



[Table of Contents]

REPAIRING, REBUILDING & RESTORING	117
BELT REPAIRS & URETHANES	119
MAINTENANCE & REPAIR EPOXIES	121

CHOOSING A REPAIR EPOXY

When choosing a repair epoxy, there are several factors to consider, the most important of which is substrate. Loctite® Fixmaster® repair epoxies are designed to optimize performance on various substrates. The coefficient of thermal expansion differs from one metal to the next; matching the correct product to each substrate will make a big impact on the integrity of the repair. The application and service environment are important to consider because machinability and corrosion resistance differ between the products.

WHAT IS THE PROPER SURFACE PREPARATION FOR REPAIR EPOXIES?

A properly prepared surface is one that has been cleaned, dried and abraded. Substrates should be free from contamination, including oils, grease, dust, etc. It is also important that a surface is dry* before working with a repair epoxy, because moisture on the surface can interfere with the curing process. The final component is to abrade the surface, which provides an increased surface area for bonding. When working with metals, the surface should be abraded to a near-white metal finish, which also helps to ensure that all surface corrosion is removed.

* Loctite® Fixmaster® Wet Surface Repair Putty and Loctite® Fixmaster® Underwater Repair Epoxy have been specially formulated to cure in wet or underwater applications.



Your Source **BELT REPAIR & URETHANES SELECTOR GUIDE**

WHAT TYPE OF APPLICATION IS NEEDED?

General Rubber Repair	Belt Repair
Castable	Short-Term
Loctite® Fixmaster® Flex 80™ Liquid Item # 97413 1 lb. kit 97412 6 lb. kit	Loctite® Fixmaster® Instant Belt Repair Item # 37719 1 lb. kit
Trowelable	Long-Term
Loctite® Fixmaster® Flex 80™ Putty Item # 97423 1 lb. kit 97422 6 lb. kit	FAST RETURN TO SERVICE Loctite® Fixmaster® Rapid Rubber Repair Item # 96677 400 ml kit 96675 400 ml cartridge 96676 150 ml coaxial cartridge
	LONGER WORKING TIME
	Loctite® Fixmaster® Flex™ Conveyor Belt Repair Kit Item # 98693 1 lb. kit

Loctite® Adhesives and Sealants Product Specialists are available to assist you. For application assistance, call **1-800-LOCTITE (562-8483)**; *within Canada, call 1-800-263-5043*; or, contact us through the web at www.henkelna.com/loctite.

STRAIGHT FROM *The Source*

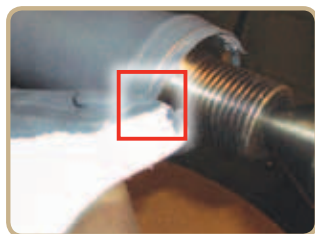

Your Source MAINTENANCE & REPAIR EPOXIES SELECTOR GUIDE

WHAT TYPE OF APPLICATION IS NEEDED?

Metal Repair	Specialty	Kneadable Sticks
<p>HIGH PERFORMANCE</p> <p>Loctite® Fixmaster® Superior Metal</p> <p>Item # 97473 1 lb. kit 40900 4 kg kit</p>	<p>Loctite® Fixmaster® Wet Surface Repair Putty</p> <p>Item # 96583 1 lb. kit</p>	<p>Loctite® Fixmaster® Metal Magic Steel™</p> <p>Item # 98853 4 oz. stick</p>
<p>STEEL</p> <p>Loctite® Fixmaster® Steel Putty or Liquid</p> <p>Item # Putty – 99913 1 lb. kit 99914 4 lb. kit 99912 25 lb. kit Liquid – 97483 1 lb. kit 97484 4 lb. kit</p>	<p>Loctite® Fixmaster® 2000° Putty</p> <p>Item # 95724 8 oz. can</p>	<p>Loctite® Fixmaster® Concrete Repair Epoxy</p> <p>Item # 39366 4 oz. stick</p>
<p>STAINLESS STEEL</p> <p>Loctite® Fixmaster® Stainless Steel Putty</p> <p>Item # 97443 1 lb. kit</p>		<p>Loctite® Fixmaster® Underwater Repair Epoxy</p> <p>Item # 82093 4 oz. stick</p>
<p>ALUMINUM</p> <p>Loctite® Fixmaster® Aluminum Putty or Liquid</p> <p>Item # Putty – 97463 1 lb. kit 97453 1 lb. kit</p>		
<p>FAST SETTING</p> <p>Loctite® Fixmaster® Fast Set Steel Putty</p> <p>Item # 39917 1 lb. kit</p>		



Your Source for REPAIRING, REBUILDING & RESTORING BELT REPAIRS & URETHANES

Belt Repair:

- Provides durable, tough, and flexible repairs of conveyor belts and other damaged rubber equipment quickly and easily

Urethanes:

- Can be troweled, cast or brush-applied to rebuild or protect critical operating equipment
- Provides protection from impact, abrasion and corrosion
- Non-shrinking and unaffected by oil, grease and water
- Maximum adhesion and product reliability ensured by use of recommended accessories



[Belt Repair]

Loctite® Fixmaster® Rapid Rubber Repair

Our premium quality belt repair product is designed to repair conveyor belts and other damaged rubber equipment quickly and easily. Repairs will have the same durability and flexibility as the belt. The 400 ml cartridge requires the use of a Loctite® Rapid Rubber Repair Dispenser. The 400 ml kit contains a 400 ml cartridge, etching agent, cleaner, brushes and plastic trowels.

- Item # 96677 400 ml kit
- 96675 400 ml cartridge
- 96676 150 ml coaxial cartridge

Fixmaster® Rapid Rubber Repair Dispenser

Handheld, manually operated dispenser designed specifically for use with Loctite® Fixmaster® Rapid Rubber Repair.

Description:

- Two-part adhesives
- 400 ml cartridges
- Medium-to-high viscosity range

- Item # 1372751 Universal Fixmaster® Dispenser
- 39633 Rapid Rubber Nozzle

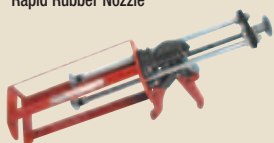

ADDITIONAL RESOURCES

Loctite® Fixmaster® Flex™ Conveyor Belt Repair Kit

Makes long-lasting belt repairs. Recommended for applications where speed of application is not critical. Cures in 8-12 hours. Kit includes resin, hardener, cleaner, etching agent, brushes and plastic trowels.

- Item # 98693 1 lb. kit

Loctite® Fixmaster® Instant Belt Repair

A single-component, heat-curing material for fast, temporary belt repairs. Requires no priming. Equipment can be operated in 30 minutes.

- Item # 37719 1 lb. kit

[General Rubber Repair]

Loctite® Fixmaster® Flex 80™ Putty

A trowelable, two-part urethane for rebuilding and repairing rubber parts and linings, providing impact-, abrasion- and corrosion-resistant protection.

- Item # 97423 1 lb. kit
- 97422 6 lb. kit

Loctite® Fixmaster® Flex 80™ Liquid

A castable, two-part urethane for making molds, fixtures, expansion joints and non-scratching holding fixtures.

- Item # 97413 1 lb. kit
- 97412 6 lb. kit

[Loctite® Fixmaster® Belt Repair & Urethane Application Chart]

LOCTITE® PRODUCT	CASTING MOLDS, FIXTURES, PARTS	CONVEYOR BELT REPAIR (LONG-TERM)	CONVEYOR BELT REPAIR (TEMPORARY)	COATING IMPELLERS, FEEDER BOWLS	CHUTES, HOPPERS, DEFLECTION PLATES	REBUILDING RUBBER PARTS	LINING PUMPS	FORMING EXPANSION JOINTS
FIXMASTER® RAPID RUBBER REPAIR		▲					△	△
FIXMASTER® FLEX™ CONVEYOR BELT REPAIR KIT		△						
FIXMASTER® INSTANT BELT REPAIR			▲					
FIXMASTER® FLEX 80™ PUTTY	△				▲	▲	▲	
FIXMASTER® FLEX 80™ LIQUID	▲			△				▲

△ Good Choice ▲ Preferred Choice

Sources REVEALED

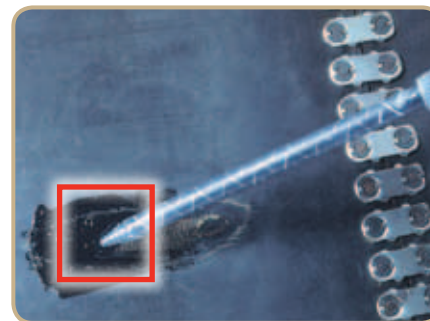
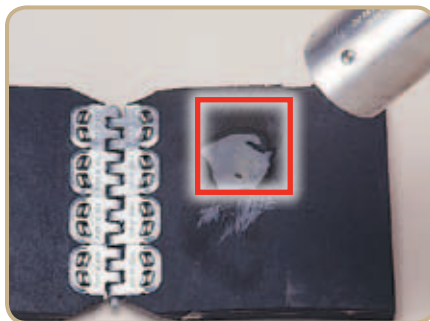

[Applications]

- Pump
- Gearbox
- Concrete Repair
- Conveyor Systems
- Shaft Repair

[Industries]

- Mining
- Wastewater
- Power Generation

- Food Processing
- Pulp and Paper
- Beverage

APPLICATIONS & INDUSTRIES

[Loctite® Belt Repair & Urethane Properties Chart]

	LOCTITE® PRODUCT	ITEM NUMBER	PACKAGE TYPE & SIZE	COLOR	COVERAGE (IN. ² AT 1/4 IN. THICKNESS)	MAXIMUM OPERATING TEMPERATURE (°F)	ADHESIVE TENSILE STRENGTH (psi)	% ELONGATION	HARDNESS (SHORE A)	WORKING TIME (MINUTES)	FUNCTIONAL CURE (HOURS)	MIX RATIO BY VOLUME (RESIN: HARDENER)	MIX RATIO BY WEIGHT (RESIN: HARDENER)	AGENCY APPROVALS
BELT REPAIR	FIXMASTER® RAPID RUBBER REPAIR	96677 96675 96676	400 ml kit 400 ml cartridge 150 ml coaxial cartridge	Black	88 88 33	180	1,300	360	82	1	2	1:1	N/A	N/A
	FIXMASTER® FLEX™ CONVEYOR BELT REPAIR KIT	98693	1 lb. kit	Black	94	180	1,500	350	87	10	8	100:40	72:28	N/A
	FIXMASTER® INSTANT BELT REPAIR	37719	1 lb. kit	Yellow	115	150	400	650	65	N/A	30 min.	N/A	N/A	N/A
GENERAL RUBBER REPAIR	FIXMASTER® FLEX 80™ PUTTY	97423 97422	1 lb. kit 6 lb. kit	Black	94 564	180	1,500	350	87	10	8	100:40	72:28	ABS
	FIXMASTER® FLEX 80™ LIQUID	97413 97412	1 lb. kit 6 lb. kit	Black	27 in. ³ 162 in. ³	180	1,800	350	87	20	8	100:13.3	77:23	N/A

Properties based on mixing a 1 lb. unit at 77°F, seven days cure.

[Loctite® Belt Repair Accessories Chart]

- Loctite® Fixmaster® Instant Belt Repair is a hot melt adhesive and requires heat for application.
- Loctite® Fixmaster® Flex 80™ Liquid can be used as a flexible joint sealant where a black color is desired.

HELPFUL HINTS

	LOCTITE® PRODUCT	ITEM NUMBER	PACKAGE DESCRIPTION	COVERAGE	COLOR	
BELT REPAIR ACCESSORIES	FLEX™ METAL PRIMER	98471	Promotes adhesion to metal parts	3.3 fl. oz. can	190 in ² or approximately 1 can of each product for 2 lbs. of urethane	Clear
	ETCHING AGENT	99626	Enhances bonds to rubber	3 fl. oz. bottle	Clear	
	FLEX™ CLEANER	39636	Cleans and primes surfaces	4 fl. oz. can	N/A	Clear
	FIXMASTER® RAPID RUBBER REPAIR	1372751	Dispenser	Required for use with 400 ml cartridge of Loctite® Fixmaster® Rapid Rubber Repair (Item Number 1372751 is not included in the 96677 kit and must be ordered separately.)		
	FIXMASTER® RAPID RUBBER REPAIR	39633	Static Mixers	Packaged 6/bag – for mixing and dispensing Loctite® Fixmaster® Rapid Rubber Repair in a 400 ml cartridge		

Your Source for REPAIRING,
REBUILDING & RESTORING
**MAINTENANCE &
REPAIR EPOXIES**



[Epoxy Sticks]

Source's PICK

**Loctite® Fixmaster®
Metal Magic Steel™**

Steel epoxy in stick form. Cut off a section, knead and apply to leaking pipes or damaged equipment. Cures in 10 minutes. NSF® 61 approved for potable water applications.

Item # 98853 4 oz. stick

**Loctite® Fixmaster®
Concrete Repair Epoxy**

Enables permanent repairs to concrete and masonry. Convenient stick contains pre-measured portions of activator and base. Once cured, it can be tapped, drilled, screwed, sawed, filed or painted, and will have an appearance and texture similar to concrete.

Item # 39366 4 oz. stick

**Loctite® Fixmaster®
Underwater Repair Epoxy**

This putty-like material is ideal for plumbing, irrigation and marine applications because it is unaffected by chlorinated or salt water. Will stick to wet surfaces. Ideally suited for underwater repairs.

Item # 82093 4 oz. stick

Your Source for **SUPERIOR METAL**
Loctite® Fixmaster® Superior Metal 6-Step Process



STEP 1:
Clean completely



STEP 2:
Gather product



STEP 3:
Prepare product



STEP 4:
Mix completely



STEP 5:
Apply



STEP 6:
Set

- The working time of an epoxy is the time required for the viscosity to double. Once the viscosity has doubled, epoxies are generally very hard to work with, so jobs should be completed before this time.
- Increasing the temperature of the product or substrate can increase the cure speed of an epoxy and reduce the viscosity initially.

HELPFUL HINTS

Sources REVEALED



[Applications]

- Pump
- Gearbox
- Concrete Repair
- Conveyor Systems
- Shaft Repair

[Industries]

- Mining
- Wastewater
- Power Generation

- Food Processing
- Pulp and Paper
- Beverage

APPLICATIONS & INDUSTRIES

[Pourable Metal-Filled Epoxies]

Loctite® Fixmaster® Steel Liquid

Pourable and self-leveling, steel-filled epoxy. Ideal for casting or making molds. Works well to fill hard-to-reach areas. Can be machined when cured.

Item # 97483 1 lb. kit
97484 4 lb. kit

Loctite® Fixmaster® Aluminum Liquid

Similar to Loctite® Fixmaster® Steel Liquid, but aluminum-filled.

Item # 97453 1 lb. kit

[Trowelable Metal-Filled Epoxies]

Loctite® Fixmaster® Superior Metal

Non-rusting, ferro-silicon-filled epoxy. Extremely high compressive strength and wear resistance. Ideal for rebuilding worn surfaces exposed to harsh environments. Can be machined, drilled and tapped in 6-8 hours. For final finish cuts, let the product cure for 24 hours and use carbide tooling. Spreadable putty.

Item # 97473 1 lb. kit
40900 4 kg kit

Loctite® Fixmaster® Steel Putty

Non-slumping, two-part, steel-filled putty. Ideally suited for rebuilding steel surfaces. Can be machined when cured.

Item # 99913 1 lb. kit
99914 4 lb. kit
99912 25 lb. kit

Loctite® Fixmaster® Aluminum Putty

Similar to Loctite® Fixmaster® Steel Putty, but aluminum-filled to better match the coefficient of thermal expansion of aluminum.

Item # 97463 1 lb. kit

Loctite® Fixmaster® Stainless Steel Putty

Similar to Loctite® Fixmaster® Steel Putty, but stainless steel-filled to better match the coefficient of thermal expansion of stainless steel.

Item # 97443 1 lb. kit

Loctite® Fixmaster® Fast Set Steel Putty

Faster setting version of Loctite® Fixmaster® Steel Putty.

Item # 39917 1 lb. kit

[High Performance]

Loctite® Fixmaster® Fast Set Steel Epoxy

Cartridge-based, steel-filled epoxy. Makes fast, cost-effective repairs. Easy to use and easy to apply. Ideal for metal parts that must be back in service quickly. Can be machined when cured. Requires the handheld dispenser (Item No. 98472). One mix nozzle comes included with the cartridge.

Item # 96604 50 ml cartridge

Loctite® Fixmaster® Wear Resistant Putty

Ceramic fibers give this trowelable putty excellent wear- and abrasion-resistant properties. Cures to a smooth, low friction surface. For surfaces exposed to wear, erosion and cavitation.

Item # 98742 1 lb. kit
98743 3 lb. kit

[Specialty Products]

Loctite® Fixmaster® Wet Surface Repair Putty

Use this unique, trowelable epoxy to repair and rebuild wet, even underwater surfaces. Bonds to most metals, concrete and some plastics.

Item # 96583 1 lb. kit

Loctite® Fixmaster® 2000° Putty

Single-component putty designed to fill and restore damaged metal and fill cracks in environments that will see 2000°F. Water-based and nontoxic. Typical applications include header, manifold and cast iron repair.

Item # 95724 8 oz. can

Loctite® Fast Cure Mixer Cups

Pre-measured epoxy mixer cups are ideally suited for applications requiring only a small amount of epoxy. Fills porosity and cracks. Adheres to metal, glass, wood and hard plastics. Grey.

Item # 21425 10 - 0.12 fl. oz. cups
21426 10 - 1 oz. cups
39088 4 - 0.12 fl. oz. cups

Source's PICK

Your Source for **REPAIRING, REBUILDING & RESTORING MAINTENANCE & REPAIR EPOXIES**



[**Loctite® Fixmaster® Maintenance & Repair Epoxies Properties Chart**]

	LOCTITE® PRODUCT	ITEM NUMBER	PACKAGE TYPE & SIZE	COLOR	COVERAGE	MAXIMUM TEMPERATURE† (°F)	COMPRESSIVE STRENGTH (psi)†	TENSILE STRENGTH† (psi)	HARDNESS (SHORE D)	WORKING TIME	FUNCTIONAL CURE	MIX RATIO BY VOLUME	MIX RATIO BY WEIGHT	AGENCY APPROVALS
EPOXY STICKS	FIXMASTER® METAL MAGIC STEEL™*	98853	4 oz. stick	Grey	16 in. ^{2**}	250	12,000	2,500	80	3 minutes	10 minutes	N/A	N/A	NSF® 61
	FIXMASTER® CONCRETE REPAIR EPOXY	39366	4 oz. stick	Grey	16 in. ^{2**}	250	12,000	2,500	80	4 to 7 minutes	10 minutes	N/A	N/A	N/A
	FIXMASTER® UNDERWATER REPAIR EPOXY®	82093	4 oz. stick	White	16 in. ^{2**}	300	12,000	900	70	15 minutes	30 minutes	N/A	N/A	CFIA
POURABLE	FIXMASTER® STEEL LIQUID*	97483 97484	1 lb. kit 4 lb. kit	Grey	13 in. ³ 52 in. ³	225	13,500	6,000	86	25 minutes	6 hours	4:1	9.5:1	ABS, CFIA, NEHC, NAVSEA
	FIXMASTER® ALUMINUM LIQUID*	97453	1 lb. kit	Aluminum	17 in. ³	200	17,000	6,000	85	20 minutes	6 hours	5:1	9:1	ABS, CFIA, NEHC, NAVSEA
TROWELABLE	FIXMASTER® SUPERIOR METAL*	97473 40900	1 lb. kit 4 kg kit	Dark Grey	0.25 ft. ^{2**} 2.2 ft. ^{2**}	250	18,000	5,500	90	20 minutes	6 hours	4:1	7.25:1	CFIA
	FIXMASTER® STEEL PUTTY*	99913 99914 99912	1 lb. kit 4 lb. kit 25 lb. kit	Grey	0.3 ft. ^{2**} 1.2 ft. ^{2**} 7.5 ft. ^{2**}	225	11,100	4,900	85	30 minutes	6 hours	2.5:1	6.25:1	ABS, CFIA, NEHC, NAVSEA
	FIXMASTER® ALUMINUM PUTTY*	97463	1 lb. kit	Aluminum	0.5 ft. ^{2**}	200	11,300	4,000	87	20 minutes	6 hours	4:1	6.3:1	ABS, CFIA, NEHC, NAVSEA
	FIXMASTER® STAINLESS STEEL PUTTY*	97443	1 lb. kit	Grey	0.25 ft. ^{2**}	225	12,000	4,600	85	20 minutes	6 hours	4:1	9:1	ABS, CFIA, NEHC, NAVSEA
	FIXMASTER® FAST SET STEEL PUTTY*	39917	1 lb. kit	Grey	0.4 ft. ^{2**}	200	10,800	4,600	80	3 minutes	10 minutes	1:1	1.8:1	ABS, CFIA, NEHC, NAVSEA

	LOCTITE® PRODUCT	ITEM NUMBER	PACKAGE TYPE & SIZE	COLOR (CURED)	MAXIMUM TEMPERATURE† (°F)	TENSILE STRENGTH (psi)	WORK LIFE	FIXTURE TIME‡	FULL CURE (HOURS)	AGENCY APPROVALS
HIGH PERFORMANCE	FIXMASTER® FAST SET STEEL EPOXY*	96604	50 ml cartridge	Grey	200	2,600	3 minutes	6 to 8 minutes	7	CFIA
	FIXMASTER® WEAR RESISTANT PUTTY*	98742 98743	1 lb. kit 3 lb. kit	Grey	225	1,450	30 minutes	1 hour	6	ABS, CFIA, NEHC, NAVSEA
SPECIALTY PRODUCTS	FIXMASTER® WET SURFACE REPAIR PUTTY*	96583	1 lb. kit	Grey	150	2,000	30 minutes	1 hour	18	ABS, NEHC, NAVSEA
	FIXMASTER® 2000® PUTTY*	95724	8 oz. can	Grey	2000	675	30 minutes	1 hour	7	N/A
	FAST CURE MIXER CUPS	21425 21426	10 – 0.12 fl. oz. cups 10 – 1 oz. cups	Grey	180	2,000	5	10	12	
APPLICATORS	MANUAL CARTRIDGE APPLICATOR	98472	Required for use with Loctite® Fixmaster® 50 ml cartridges. (Item No. 98455 is also required and must be ordered separately.) For more information on spare parts, nozzles and accessories, please visit www.equipment.loctite.com .							
	STATIC MIX NOZZLES	98455	Packaged 10/bag – for mixing and dispensing Loctite® Fixmaster® 50 ml cartridges. For more information on spare parts, nozzles and accessories, please visit www.equipment.com .							

ITEMS IN RED = Source's PICK or NEW

* Properties are based on mixing one lb. mass at 77°F, seven days cure.
 ** At 1/4 in. thickness.
 † Ultimate cure.

‡ Time to reach handling strength.
 § Properties based on ultimate cure. Epoxy properties based on mixing 20 g mass at 77°F.

[Loctite® Fixmaster® Maintenance & Repair Epoxies Application Chart]

LOCTITE® PRODUCT		EMERGENCY METAL REPAIRS	CORROSION PROTECTION	REPAIRING PIPES & TANKS	REBUILDING SHAFTS, KEYWAYS & BEARINGS	REPAIRING THREADED PARTS	RESTORING TUBE SHEETS	PUMP REPAIR	REPAIRING ENGINE BLOCKS	FIXTURES & PROTOTYPES	REBUILDING IMPELLERS & VALVES	REPAIRING ALUMINUM PARTS	REPAIRING STAINLESS STEEL PARTS	FORMING MOLDS & FIXTURES	WET SURFACE REPAIRS
EPOXY STICKS	FIXMASTER® METAL MAGIC STEEL™	▲		△						▲				▲	△
	FIXMASTER® CONCRETE REPAIR EPOXY	△								△					■
	FIXMASTER® UNDERWATER REPAIR EPOXY	△		△											▲
POURABLE	FIXMASTER® STEEL LIQUID			▲		▲				△				▲	
	FIXMASTER® ALUMINUM LIQUID									▲		▲	△	▲	
TROWELABLE	FIXMASTER® SUPERIOR METAL		▲		▲	▲	▲	▲	▲		▲				
	FIXMASTER® STEEL PUTTY			▲					▲		△			▲	
	FIXMASTER® ALUMINUM PUTTY		△								▲	▲	△		
	FIXMASTER® STAINLESS STEEL PUTTY		△								▲	△	▲		
	FIXMASTER® FAST SET STEEL PUTTY	▲		▲					△						

ITEMS IN RED = Source's PICK or NEW △ Good Choice ▲ Preferred Choice ■ Acceptable Choice

[Loctite® Fixmaster® Maintenance & Repair Epoxies Bonding Characteristics]

LOCTITE® PRODUCT		GAP FILLING	FAST CURE TIME	FERROUS METAL REPAIR	TOUGHENED FORMULATION	SHOCK RESISTANT	WATER RESISTANT	PLASTIC BONDING	RUBBER BONDING	METAL BONDING	SANDABLE FINISH	PAINTABLE FINISH
HIGH PERFORMANCE	FIXMASTER® FAST SET STEEL EPOXY	△	▲	▲						△	▲	■
	FIXMASTER® WEAR RESISTANT PUTTY	▲			▲	▲	△					■
SPECIALTY PRODUCTS	FIXMASTER® WET SURFACE REPAIR PUTTY	▲					▲					■
	FIXMASTER® 2000° PUTTY	▲		▲							■	■

△ Good Choice ▲ Preferred Choice ■ Acceptable Choice

Your Source for RETAINING

[Table of Contents]

RETAINING	125
RETAINING COMPOUNDS	127
RETAINING COMPOUNDS EQUIPMENT	131



CHOOSING A RETAINING COMPOUND

Retaining compounds are typically used to join non-threaded cylindrical assemblies made of some sort of metal. Metals can be designated as active or inactive. Active metals (carbon steel, copper or bronze) will typically corrode faster than inactive metals (stainless steel, plated parts or anodized aluminum). When working with inactive metals, it is generally recommended that a primer be used to increase the cure speed of the retaining compound.

Historically, new Loctite® retaining compounds have been formulated as liquids due to their reactivity. This ensures that they remain stable and ready for use. Recent breakthroughs have led to the development of a stable, semisolid stick formulation. This has opened the door to applications where previously the liquids were considered too messy or inconvenient. This new semisolid formulation allows direct contact of the compound to the part. It ensures not only that the product is placed exactly where it is needed, but also that it stays there as the cylindrical assembly is positioned and assembled.

THE FOLLOWING ARE KEY FACTORS TO CONSIDER WHEN CHOOSING A RETAINING COMPOUND

- 1. Gap Size Between Parts** – Typically, low viscosity retaining compounds (125 to 2,000 cP) are used for gaps up to 0.010 in. For gaps greater than 0.010 in., retaining compounds with higher viscosities (>2,000 cP) should be used.
- 2. Temperature Resistance** – Most Loctite® retaining compounds are made to withstand temperatures up to 300°F (149°C). For those applications that require resistance greater than 300°F (149°C), Henkel offers a line of high temperature-resistant Loctite® retaining compounds that can withstand temperatures up to 450°F (232°C).
- 3. Bond Strength** – In applications that require a permanent bond, a high-strength retaining compound is recommended. If at some point in the future, parts will need to be taken apart for service, it is better to use a low- or medium-strength product.
- 4. Cure Speed** – Many production applications require retaining compounds with fast cure speed in order to maximize production rate. On the other hand, some applications require a slower cure so that adjustments can be made after the parts have been assembled. Our range of Loctite® retaining compounds offers varying rates of cure, enabling you to choose the one that best matches your application.

Loctite® Adhesives and Sealants Product Specialists are available to assist you with new product designs, or to help you re-engineer an existing application for improved performance and cost savings. They can also set up testing of your parts at the Henkel Customer Engineering Center. For application assistance, call **1-800-LOCTITE (562-8483)**; *within Canada, call 1-800-263-5043*; or contact us through the web at www.henkelna.com/loctite.

STRAIGHT FROM *The Source*

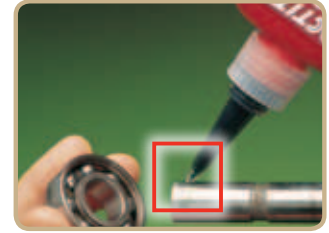

Your Source RETAINING COMPOUNDS SELECTOR GUIDE

WHAT TYPE OF PARTS ARE BEING ASSEMBLED?

Worn Parts Up to 0.020 in. Gap

Loctite® 660™ Quick Metal™ Retaining Compound

- Item # 66010 6 ml tube
- Item # 66040 50 ml tube

Loose-Fitting Parts Between 0.010 in. to 0.015 in. Gap

TEMPERATURES ABOVE 300°F (149°C)

Loctite® 620™ Retaining Compound

- Item # 62005 0.5 ml capsule
- Item # 62015 10 ml bottle
- Item # 62040 50 ml bottle
- Item # 62070 250 ml bottle
- Item # 62085 1 liter bottle

300°F (149°C) MAXIMUM TEMPERATURE

Loctite® 232™ Retaining Compound

- Item # 18607 1 liter bottle
- Item # 27863 250 ml bottle

LOW STRENGTH

Loctite® 641™ Retaining Compound

- Item # 28802 10 ml bottle
- Item # 21458 50 ml bottle

MEDIUM STRENGTH

Loctite® 638™ Retaining Compound

- Item # 21447 10 ml bottle
- Item # 21448 50 ml bottle
- Item # 21449 250 ml bottle

HIGH STRENGTH
5-MINUTE FIXTURE

Loctite® 680™ Retaining Compound

- Item # 68005 0.5 ml capsule
- Item # 68015 10 ml bottle
- Item # 68035 50 ml bottle
- Item # 68060 250 ml bottle
- Item # 68090 1 liter bottle

HIGH STRENGTH
10-MINUTE FIXTURE

Loctite® 635™ Retaining Compound

- Item # 63531 50 ml bottle
- Item # 63541 250 ml bottle

HIGH STRENGTH
1-HOUR FIXTURE

Close-Fitting Parts Up to 0.010 in. Gap

400°F (204°C) MAXIMUM TEMPERATURE

Loctite® QuickStix® 668™ Retaining Compound

- Item # 39148 19 g stick

450°F (232°C) MAXIMUM TEMPERATURE

Loctite® 640™ Retaining Compound

- Item # 64031 50 ml bottle
- Item # 64041 250 ml bottle

300°F (149°C) MAXIMUM TEMPERATURE

Oil Contamination

YES

Loctite® 603™ Retaining Compound

- Item # 21440 10 ml bottle
- Item # 21441 50 ml bottle
- Item # 21442 250 ml bottle

NO

Loctite® 609™ Retaining Compound

- Item # 60905 0.5 ml capsule
- Item # 60921 10 ml bottle
- Item # 60931 50 ml bottle
- Item # 60941 250 ml bottle
- Item # 60943 1 liter bottle

MEDIUM STRENGTH

Loctite® 648™ Retaining Compound

- Item # 21443 10 ml bottle
- Item # 21444 50 ml bottle
- Item # 21445 250 ml bottle

HIGH STRENGTH
5-MINUTE FIXTURE

Loctite® 675™ Retaining Compound

- Item # 67541 250 ml bottle

HIGH STRENGTH
20-MINUTE FIXTURE

Your Source for **RETAINING** **RETAINING COMPOUNDS**

- Increases the shear strength of cylindrical, non-threaded assemblies
- An industry standard for assembling press- and slip-fitted parts
- Fills the “inner space” between components and cures to form a strong precision assembly
- Formulated in a variety of viscosities, gap fills, flexibility and strength characteristics
- Can be applied with automated process equipment or dispensed manually

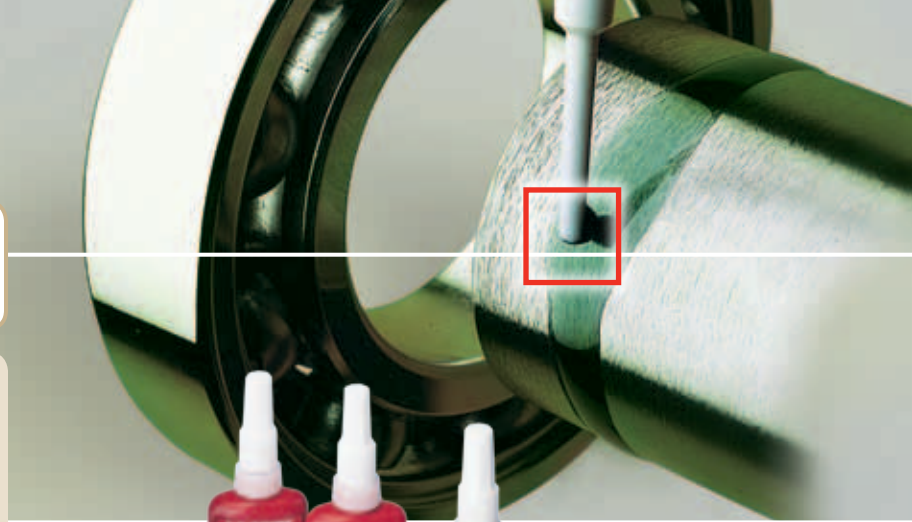

[Close-Fitting Parts]

Loctite® 232™ Retaining Compound

HEAVY PRESS FIT/MEDIUM STRENGTH

A medium viscosity, medium strength retaining compound with slow cure and lubricity for heavy press fits and highly torqued threaded assemblies.

Item # 18607 1 liter bottle
27863 250 ml bottle

Loctite® 603™ Retaining Compound

PRESS FIT/OIL TOLERANT

A retaining compound tolerant of oil and other contamination. Seals and secures cylindrical assemblies up to 0.005 in. diametral clearance. Fixtures in 10 minutes. Prevents fretting and corrosion of metal assemblies.

Item # 21440 10 ml bottle
21441 50 ml bottle
21442 250 ml bottle

Source's PICK

Loctite® 609™ Retaining Compound

PRESS FIT/GENERAL-PURPOSE

NEW

A low viscosity retaining compound that bonds rigid metal assemblies. Ideal for gap distances up to 0.006 in. diametral. Fixtures in 10 minutes and provides a shear strength of 3,000 psi after 24 hours. Easily joins dissimilar metals. Withstands temperatures to 300°F (149°C).

Item # 60905 0.5 ml capsule
60921 10 ml bottle
60931 50 ml bottle
60941 250 ml bottle
60943 1 liter bottle

Loctite® 648™ Retaining Compound

PRESS FIT/HIGH STRENGTH/ RAPID CURE

A retaining compound recommended for continuous working temperatures up to 300°F (149°C). Fills gaps up to 0.006 in. diametral clearance. Fixtures in 5 minutes.

Item # 21443 10 ml bottle
21444 50 ml bottle
21445 250 ml bottle

[General-Purpose]

Loctite® QuickStix® 668™ Retaining Compound

A high temperature retaining compound in a revolutionary semisolid formula. Patented, no-mess package offers added convenience and portability. Ideal for gaps up to 0.005 in. in diameter. Withstands temperatures to 400°F (204°C).

Item # 39148 19 g stick

[Medium Strength]

Loctite® 641™ Retaining Compound

PRESS & SLIP FIT/ CONTROLLED STRENGTH

A controlled strength retaining compound that is ideal for cylindrical parts that require disassembly. Recommended for maximum diametral clearance of 0.008 in. Fixtures in 20 minutes.

Item # 28802 10 ml bottle
21458 50 ml bottle



[Industries]

- Pulp and Paper
- Power Generation

- Steel Mills
- Automotive

[High Temperature]

Source's PICK

**Loctite® 620™
Retaining Compound**

SLIP FIT/HIGH TEMPERATURE

A high temperature (450°F/232°C), high viscosity liquid retaining compound. Provides a shear strength of over 3,800 psi on steel. Locks and secures metal cylindrical assemblies up to 0.015 in. diametral clearance. Prevents metal fretting and corrosion. Seals against leakage.

Item #	62005	0.5 ml capsule
	62015	10 ml bottle
	62040	50 ml bottle
	62070	250 ml bottle
	62085	1 liter bottle

[Loose-Fitting Parts]

**Loctite® 635™
Retaining Compound**

SLIP FIT/HIGH STRENGTH/SLOW CURE

A high viscosity, high strength retaining compound with slow cure speed to permit readjustment of parts during assembly.

Item #	63531	50 ml bottle
	63541	250 ml bottle

Source's PICK

**Loctite® 638™
Retaining Compound**

SLIP FIT/MAXIMUM STRENGTH

A maximum strength retaining compound for use where high dynamic force or cyclic loading is expected. Locks cylindrical assemblies up to 0.010 in. diametral clearance. Fixtures in 5 minutes.

Item #	21447	10 ml bottle
	21448	50 ml bottle
	21449	250 ml bottle

**Loctite® 680™
Retaining Compound**

SLIP FIT/HIGH STRENGTH

A high strength, high viscosity room temperature curing adhesive used to join fitted cylindrical parts. It fixtures in 10 minutes and provides a shear strength of 4,000 psi. Capable of filling diametral gaps up to 0.015 in. (0.38 mm). Loctite® 680™ allows relaxed machining tolerances, and replaces clamp rings, set screws, and snap rings.

Item #	68005	0.5 ml capsule
	68015	10 ml bottle
	68035	50 ml bottle
	68060	250 ml bottle
	68090	1 liter bottle

[Machinery Repair]

**Loctite® 660™ Quick Metal®
Retaining Compound**

PRESS FIT REPAIR

A creamy, non-running gel that is applied onto cylindrical parts to fill surface imperfections and repair worn areas. It contains no metal, but once assembled hardens to a strength that often doubles that of a press fit. Use Loctite® 660™ to salvage worn metallic parts, or to keep machinery running until new parts arrive. Use to 300°F (149°C).

Item #	66010	6 ml tube
	66040	50 ml tube

Your Source for **RETAINING**
RETAINING COMPOUNDS



[Loctite® Retaining Compounds Properties Chart]

LOCTITE® PRODUCT	ITEM NUMBER	PACKAGE TYPE & SIZE	TYPICAL USE	COLOR	MAXIMUM GAP FILL (DIAMETER-INCHES)	VISCOSITY (cP)	SHEAR STRENGTH STEEL/STEEL* (psi)	TEMPERATURE RANGE	CURE SPEED*	RECOMMENDED PRIMER CURE SPEED*	SPECIFIC GRAVITY	AGENCY APPROVALS	
CLOSE-FITTING PARTS	232™	18607 27863	1 liter bottle 250 ml bottle	Medium strength for heavy press fits	Brown	0.015 in.	5,000	1,350 psi* (2 hrs. heat cure)	-65°F (-54°C) to 300°F (149°C)	Fixture – 1 hr. Full – 24 hrs.	7088™, N™ or T™	1.02	N/A
	603™	21440 21441 21442	10 ml bottle 50 ml bottle 250 ml bottle	For close-fitting parts with light contamination	Green	0.005 in.	125	3,770	-65°F (-54°C) to 300°F (149°C)	Fixture – 10 min. Full – 24 hrs.	7088™, N™ or T™	1.10	N/A
	609™	60905 60921 60931 60941 60943	0.5 ml capsule 10 ml bottle 50 ml bottle 250 ml bottle 1 liter bottle	1st generation to augment press fits	Green	0.006 in.	125	2,300 (minimum)	-65°F (-54°C) to 300°F (149°C)	Fixture – 10 min. Full – 24 hrs.	7088™, N™ or T™	1.10	MIL-R-46082B for existing designs, ASTM D-5363**, CFIA
	648™	21443 21444 21445	10 ml bottle 50 ml bottle 250 ml bottle	Fast fixturing for close-fitting parts, high strength for stainless steel	Green	0.006 in.	500	3,900	-65°F (-54°C) to 300°F (149°C)	Fixture – 5 min. Full – 24 hrs.	7088™, N™ or T™	1.13	N/A
	675™	67541	250 ml bottle	First generation for close-fitting parts	Green	0.005 in.	125	3,000	-65°F (-54°C) to 300°F (149°C)	Fixture – 20 min. Full – 24 hrs.	7088™, N™ or T™	1.09	MIL-R-46082B for existing designs, ASTM D-5363**
GENERAL-PURPOSE	QUICKSTIX® 668™	39148	19 g stick	General-purpose, high temperature	Green Stick	0.005 in.	Semisolid	3,800	-65°F (-54°C) to 400°F (204°C)	Fixture – 20 min. Full – 24 hrs.	7088™, N™ or T™	1.1228	N/A
HIGH TEMPERATURE	620™	62005 62015 62040 62070 62085	0.5 ml capsule 10 ml bottle 50 ml bottle 250 ml bottle 1 liter bottle	For high temperature applications	Green	0.015 in.	8,500	3,800	-65°F (-54°C) to 450°F (232°C)	Fixture – 1 hr. Full – 24 hrs.	7088™, N™ or T™	1.16	CFIA, ABS
	640™	64031 64041	50 ml bottle 250 ml bottle	For high temperature applications	Green	0.007 in.	600	3,000	-65°F (-54°C) to 400°F (204°C)	Fixture – 30 min. Full – 24 hrs.	7088™, N™ or T™	1.2	MIL-R-46082B for existing designs, ASTM D-5363**



ITEMS IN RED = Source's PICK or NEW

* Varies with substrates.
** For new designs.

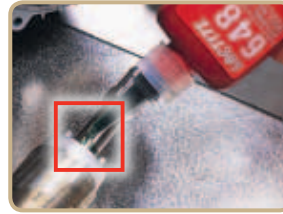
🌐 = Indicates Worldwide Availability



[Loctite® Retaining Compounds Properties Chart]

LOCTITE® PRODUCT	ITEM NUMBER	PACKAGE TYPE & SIZE	TYPICAL USE	COLOR	MAXIMUM GAP FILL (DIAMETER)	VISCOSITY (cP)	SHEAR STRENGTH STEEL/STEEL* (psi)	TEMPERATURE RANGE	CURE SPEED*	RECOMMENDED PRIMER CURE SPEED*	SPECIFIC GRAVITY	AGENCY APPROVALS	
635™	63531 63541	50 ml bottle 250 ml bottle	First generation high strength for slip fits	Green	0.010 in.	2,000	4,500	-65°F (-54°C) to 300°F (149°C)	Fixture – 1 hr. Full – 24 hrs.	7088™, N™ or T™	1.1	MIL-R-46082B for existing designs, ASTM D5363**	
	638™ 	21447 21448 21449	10 ml bottle 50 ml bottle 250 ml bottle	High strength for loose-fitting parts	Green	0.015 in.	2,500	4,500	-65°F (-54°C) to 300°F (149°C)	Fixture – 5 min. Full – 24 hrs.	7088™, N™ or T™	1.09	CFIA
		680™	68005 68015 68035 68060 68090	0.5 ml capsule 10 ml bottle 50 ml bottle 250 ml bottle 1 liter bottle	High strength for slip-fitted parts	Green	0.015 in.	1,250	4,000	-65°F (-54°C) to 300°F (149°C)	Fixture – 10 min. Full – 24 hrs.	7088™, N™ or T™	1.10
641™ 	28802 21458	10 ml bottle 50 ml bottle	Medium strength for easier disassembly	Yellow	0.008 in.	525/1,950 Thixotropic	1,700	-65°F (-54°C) to 300°F (149°C)	Fixture – 20 min. Full – 24 hrs.	7088™, N™ or T™	1.07	CFIA	
660™ QUICK METAL® 	66010 66040	6 ml tube 50 ml tube	For repair of worn machinery parts	Silver	0.020 in.	250,000/ 1,500,000 Thixotropic	3,335	-65°F (-54°C) to 300°F (149°C)	Fixture – 20 min. Full – 24 hrs.	7088™, N™ or T™	1.13	CFIA	

ITEMS IN RED = Source's PICK or NEW

* Varies with substrates.
** For new designs.

 = Indicates Worldwide Availability

RETAINING HINTS



- Clean parts with Loctite® ODC-Free Cleaner & Degreaser before applying the adhesive.
- If the threadlocker will be applied below 40°F (4°C), pre-treat with Loctite® 7649™ Primer N™.
- If the parts were in contact with aqueous washing solutions or cutting fluids that leave a protective layer on the surface, wash with hot water before use.





HELPFUL HINTS

Your Source for **RETAINING** **RETAINING COMPOUNDS** **EQUIPMENT**

YOUR EQUIPMENT *Source*

For more details, see the **Loctite® Equipment Sourcebook, LT-3669**, or visit us on the web for additional information, diagrams, products and our full line of equipment at www.equipment.loctite.com.



LOCTITE® PRODUCT		ITEM NUMBER	USED TO DISPENSE	PACKAGE TYPES & SIZES	VISCOSITY RANGE	PACKAGE TYPES & SIZES	CONSUMABLES – DISPENSE ACCESSORIES
BOTTLE DISPENSING							
	SOFT SQUEEZE BOTTLES	98345	All Fluids	2 fl. oz. packages	Low to Medium	Manual	N/A
		98346	All Fluids	4 fl. oz. packages			
		98347	All Fluids	8 fl. oz. packages			
	50 ML AND 250 ML HAND PUMPS	98414 97001	Retaining Compounds, Threadlockers	50 ml bottle 250 ml bottle	Low to Medium	Manual	Dispense Tips & Accessories – Pages 182-186
TUBE DISPENSING							
	50 ML-F TUBE SQUEEZE DISPENSER	1083845	Any 50 ml tube	50 ml tubes	Low to High	Manual	N/A





LOCTITE® PRODUCT		ITEM NUMBER	PRESSURE REGULATION	USED TO DISPENSE	PACKAGE TYPES & SIZES	VISCOSITY RANGE	LOW LEVEL SENSING	CONSUMABLES – DISPENSE ACCESSORIES	
INTEGRATED RESERVOIR CONTROLLERS									
	INTEGRATED SEMI-AUTOMATIC DISPENSER	1390322	0 to 15 psi	Gel Adhesives, Instant Adhesives, Light Cure/Acrylics, Retaining Compounds, Threadlockers	250 ml bottle 1 lb. bottle 1 liter bottle 2 kg bottle 200 g squeeze tube	Low to Medium	Yes	Dispense Tips & Accessories – Pages 182-186	
		1390321	0 to 100 psi				Medium to High		Yes
RESERVOIRS									
	BOND-A-MATIC® 3000 RESERVOIR	982720	0 to 15 psi	Gel Adhesives, Instant Adhesives, Light Cure/Acrylics, Retaining Compounds, Threadlockers	250 ml bottle 1 lb. bottle 1 liter bottle 2 kg bottle 200 g squeeze tube	Low to Medium	Yes	Dispense Tips & Accessories – Pages 182-186	
		982726					No		
		982723	0 to 100 psi				Medium to High		Yes
		982727					No		
	SHOT MISER™ RESERVOIR	98090	0 to 100 psi	Instant Adhesives, Light Cure/Acrylics, Retaining Compounds, Threadlockers	250 ml bottle 1 lb. bottle 200 g squeeze tube	Low to High	No		
	4 LITER GRAVITY FEED RESERVOIR	982880	N/A	Retaining Compounds, Threadlockers	Direct Fill	Low to Medium	Yes		







LOCTITE® BRANDED EQUIPMENT – Loctite® is a full service supplier of equipment and offers a wide variety of equipment services to its customers. **For more Loctite® branded equipment, go to page 171.**

Can't find what you're looking for? Visit www.equipment.loctite.com or call 1-800-LOCTITE (562-8483).

STRAIGHT FROM *The Source*

LOCTITE® PRODUCT		ITEM NUMBER	DISPENSE PATTERNS	USED TO DISPENSE	PACKAGE TYPES & SIZES	VISCOSITY RANGE	VACUUM SUCK-BACK	CONSUMABLES – DISPENSE ACCESSORIES	
DISPENSE SYSTEMS	VOLUMETRIC BOTTLE DISPENSING								
		BENCHTOP PERISTALTIC DISPENSER	98548	Dot, Drop, Bead	Instant Adhesives, Light Cure/Acrylics, Retaining Compounds, Threadlockers	Any	0 to 5,000 cP	N/A	Dispense Tips & Accessories – Pages 184-185
	COMPLETE PRESSURE-TIME BOTTLE DISPENSE SYSTEM								
		BOND-A-MATIC® 3000 DISPENSER 0-15 psi	982719	Dot, Drop, Bead	Gel Adhesives, Instant Adhesives, Light Cure/Acrylics, Retaining Compounds, Threadlockers	200 ml bottle 1 lb. bottle 1 liter bottle 2 kg bottle 200 g squeeze tube	Low	N/A	Dispense Tips & Accessories – Pages 184-185
		BOND-A-MATIC® 3000 DISPENSER 0-100 psi	982722						
		SHOT MISER™ VALVE CONTROLLER	98079	Dot, Drop, Bead	Instant Adhesives, Light Cure/Acrylics, Retaining Compounds, Threadlockers	250 ml bottle 1 lb. bottle	Low to Medium	N/A	
SHOT MISER™ DISPENSE VALVE		98085							
SHOT MISER™ RESERVOIR		98090							

LOCTITE® PRODUCT		ITEM NUMBER	TYPE	VISCOSITY RANGE	DISPENSE PATTERNS	USED TO DISPENSE	STROKE ADJUSTMENT	ACTION	CONSUMABLES – DISPENSE ACCESSORIES	
HANDHELD VALVES	GENERAL-PURPOSE APPLICATORS									
		LV HAND-HELD APPLICATOR	97130	Pneumatic	Low	Drop, Dot, Bead	Instant Adhesives, Retaining Compounds, Threadlockers	Yes	Foot	Dispense Tips & Accessories – Pages 182-186
	GENERAL-PURPOSE APPLICATORS									
		MANUAL HAND-HELD APPLICATOR	97111	Manual	Low to Medium	Drop, Dot, Bead	Light Cure/Acrylics, Retaining Compounds, Threadlockers	Yes	Finger	Dispense Tips & Accessories – Pages 182-186
		PNEUMATIC HAND-HELD APPLICATOR	97112	Pneumatic	Low to Medium	Drop, Dot, Bead	Light Cure/Acrylics, Retaining Compounds, Threadlockers	Yes	Foot	
		PNEUMATIC HAND-HELD APPLICATOR	97116	Pneumatic	Low to Medium	Drop, Dot, Bead	Light Cure/Acrylics, Retaining Compounds, Threadlockers	Yes	Finger	
GENERAL-PURPOSE APPLICATORS										
	VARI-DROP™ APPLICATORS	97131 97132	Pinch Tube	Low to Medium	Drop, Dot, Bead	Instant Adhesives, Retaining Compounds, Threadlockers	Yes	Finger	Dispense Tips & Accessories – Pages 182-186	

LOCTITE® PRODUCT		ITEM NUMBER	TYPE	VISCOSITY RANGE	DISPENSE PATTERNS	USED TO DISPENSE	STROKE ADJUSTMENT	SUCK-BACK	CONSUMABLES – DISPENSE ACCESSORIES	
VALVES & PUMPS	HIGH PRECISION VALVES									
		STATIONARY APPLICATOR VALVE	97113	High Precision	Low to Medium	Drop, Dot, Bead	Gel Instant Adhesives, Instant Adhesives, Retaining Compounds, Threadlockers	Yes	Yes	Dispense Tips & Accessories – Pages 182-186
			97114							
	HIGH PERFORMANCE DIAPHRAGM VALVES									
		LIGHT CURE DISPENSE VALVE	98009	High Performance Diaphragm	Low to Medium	Drop, Dot, Bead	Instant Adhesives, Retaining Compounds, Threadlockers	Yes	No	Dispense Tips & Accessories – Pages 182-186
		CYANOACRYLATE DISPENSE VALVE	98013	High Performance Diaphragm	Low to Medium	Drop, Dot, Bead, Microdot	Instant Adhesives, Retaining Compounds, Threadlockers	Yes	No	
	GENERAL DUTY DIAPHRAGM VALVES									
		DIAPHRAGM VALVE	97135	General Duty Diaphragm	0 to 2,500 cP	Drop, Dot, Bead	Light Cure/Acrylics, Instant Adhesives, Retaining Compounds, Threadlockers	No	No	Dispense Tips & Accessories – Pages 182-186
			97136		2,500 to 5,000 cP					
	HIGH VISCOSITY FLUID & PASTE VALVES									
	POPPET VALVE	986300	High Viscosity Fluid and Paste	Medium to High	Drop, Bead	Anaerobic Gasketing, Retaining Compounds, Threadlockers	Yes	Yes	Dispense Tips & Accessories – Pages 182-186	
PINCH TUBE VALVE										
	SHOT MISER™ DISPENSE VALVE	98085	Pinch Tube Valve	Low to Medium	Drop, Dot, Bead	Instant Adhesives, Retaining Compounds, Threadlockers	No	No	Dispense Tips & Accessories – Pages 182-186	
POSITIVE DISPLACEMENT PUMP										
	POSITIVE DISPLACEMENT PUMP	983330	Positive Displacement Valve	Low to Medium	Drop	Retaining Compounds, Threadlockers, any single-component, non-moisture-curing, low-to-medium viscosity fluid (<100,000 cP)	Yes	No	Dispense Tips & Accessories – Pages 182-186	

Your Source for
SURFACE PREPARATION

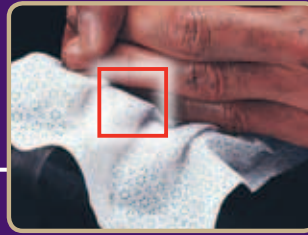

[Table of Contents]

SURFACE PREPARATION	133
CLEANERS & DEGREASERS	135
PRIMERS, ACTIVATORS & ACCELERATORS	139

CLEANERS & DEGREASERS

Loctite® cleaners and degreasers are highly effective and are available in both aqueous and solvent-based formulations. When choosing a cleaner or degreaser, the major factors to consider are dry time, residue, odor and substrate compatibility. Residue is a particularly important concern because if there is any secondary processing of the part, e.g., painting or bonding, a residue could interfere with that process. Substrate compatibility is a common concern when dealing with plastics and solvent-based cleaners. The following chart will help you to select the appropriate cleaner for your application.

Your Source **CLEANERS & DEGREASERS SELECTOR GUIDE**

WHAT TYPE OF CLEANER IS NEEDED?

Hand Wipes/ Glass Cleaner	Electrical Cleaner	Paint Remover & Strippers	Parts Cleaner
Loctite® Industrial Hand Wipes Item # 34943 75 count canister 34944 130 count bucket	Loctite® Nonflammable Electrical Contact Cleaner Item # 1174633 12 oz. net wt. aerosol	Loctite® Chisel® Paint Stripper (Methylene Chloride) Item # 79040 18 oz. net wt. aerosol	Loctite® Non-Chlorinated Parts Cleaner Item # 30545 14.75 oz. net wt. aerosol
	Loctite® Electrical Contact & Parts Cleaner Item # 25791 11 oz. net wt. aerosol	Loctite® Chisel® MC-Free Paint Stripper Item # 1317781 15.25 oz. net wt. aerosol	Loctite® Pro Strength Parts Cleaner Item # 30548 19 oz. net wt. aerosol
Degreaser			Loctite® 768™ X-NMS Cleanup Solvent Item # 76820 1.75 fl. oz. bottle 76871 1 gallon can
BIODEGRADABLE		SOLVENT-BASED	
Loctite® Natural Blue® Biodegradable Cleaner & Degreaser Item # 82244 4 fl. oz. bottle 82249 24 fl. oz. spray bottle 82251 1 gallon bottle 82253 5 gallon pail 82254 15 gallon pail 82255 55 gallon drum	Loctite® Aqua Power® Biodegradable Cleaner & Degreaser Item # 30565 17 oz. net wt. aerosol	Loctite® ODC-Free Cleaner & Degreaser (Naphtha) Item # 22355 15 oz. net wt. aerosol 20162 16 fl. oz. pump spray 20260 1 gallon can	Loctite® Pro Strength Varnish Remover Item # 30529 12 oz. net wt. aerosol
Loctite® Natural Blue® Biodegradable Cleaner & Degreaser (Fragrance-Free) Item # 23811 1 gallon bottle 20279 55 gallon drum			

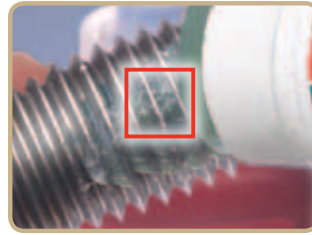

ACCELERATORS, ACTIVATORS & PRIMERS

Henkel has a complete line of Loctite® surface preparation accelerators, activators and primers, as well as a complete line of general-purpose Loctite® branded cleaners and degreasers, and specialized products to ensure the maximum performance of Loctite® adhesives and sealants.

Loctite® accelerators are used to increase the cure speed and gap-filling capabilities of cyanoacrylate adhesives. Activators are specially engineered curing agents for structural adhesives. Loctite® primers are used to ensure cure on inactive surfaces and speed the cure of machinery adhesives.

Loctite® Adhesives and Sealants Product Specialists are available to assist you with new product designs, or to help you re-engineer an existing application for improved performance and cost savings. They can also set up testing of your parts at the Henkel Customer Engineering Center. For application assistance, call **1-800-LOCTITE (562-8483)**; *within Canada, call 1-800-263-5043*; or, contact us through the web at www.henkelna.com/loctite.

STRAIGHT FROM *The Source*

Your Source PRIMERS, ACTIVATORS & ACCELERATORS SELECTOR GUIDE

PRIMER, ACTIVATOR OR ACCELERATOR?

Primers		Activators	
CYANOACRYLATES	ANAEROBICS	STRUCTURALS	ANAEROBICS
Loctite® 770™ Prism® Primer Item # 18396 1.75 fl. oz. bottle Item # 18397 16 fl. oz. can	Loctite® 7088™ QuickStix® Primer Item # 1069258 17 g stick	Loctite® 7075™ Activator Item # 21349 1 quart can Item # 22671 4.5 oz. net wt. aerosol can	Loctite® Anaerobic Activator Item # 25062 1 liter bottle
Loctite® 7951™ Prism® Primer Item # 27858 1.75 fl. oz. bottle Item # 1354770 16 fl. oz. can	Loctite® 7090™ Primer Item # 19368 1 fl. oz. bottle Item # 12695 1 liter bottle	Loctite® 7380™ Depend® Activator Item # 19822 1 liter can Item # 19824 1.75 fl. oz. bottle Item # 19907 1 gallon	
	Loctite® 7471™ Primer T™ Item # 19267 1.75 fl. oz. bottle Item # 22477 4.5 oz. net wt. aerosol can Item # 19268 1 gallon can	Loctite® 7387™ Depend® Activator Item # 18861 1.75 fl. oz. bottle Item # 18862 1 quart can Item # 21088 4.5 oz. net wt. aerosol can	
	Loctite® 7649™ Primer N™ Item # 19269 1.75 fl. oz. glass bottle Item # 21347 25 g net wt. aerosol can Item # 21348 4.5 oz. net wt. aerosol can Item # 19266 1 gallon can	Loctite® A-534R™ Activator Item # 1254434 1 quart bottle Item # 1254435 4 oz. bottle	
Accelerators			
CYANOACRYLATES			
Loctite® 712™ Tak Pak® Accelerator Item # 20352 1.75 fl. oz. bottle Item # 18636 0.7 fl. oz. metered mist Item # 18390 1 gallon can	Loctite® 7109™ Tak Pak® II Accelerator Item # 22440 1.75 fl. oz. bottle Item # 23034 1 quart can	Loctite® 7113™ Accelerator Item # 19605 1.75 fl. oz. bottle Item # 19606 1 gallon can	Loctite® 7452™ Tak Pak® Accelerator Item # 18490 1.75 fl. oz. brush-top bottle Item # 18580 1.75 fl. oz. spray-cap bottle Item # 18637 0.7 fl. oz. metered mist Item # 18575 1 quart can Item # 18576 1 gallon can

Your Source for
SURFACE PREPARATION
**CLEANERS
& DEGREASERS**



[Degreasers]

Source's PICK

**Loctite® Natural Blue®
Biodegradable Cleaner & Degreaser**

All-purpose, industrial strength, concentrated cleaner and degreaser. Can be economically diluted with water. Natural Blue® is formulated for wipe down, pressure spraying and immersion cleaning processes – at room temperature or heated. Pine-scented, nonflammable and nontoxic. Contains no ozone-depleting chemicals (ODCs). CFIA approved.

Item #	82244	4 fl. oz. bottle
	82249	24 fl. oz. spray bottle
	82251	1 gallon bottle
	82253	5 gallon pail
	82254	15 gallon pail
	82255	55 gallon drum

**Loctite® Natural Blue®
Biodegradable Cleaner & Degreaser**
FRAGRANCE-FREE

Same product as Loctite® Natural Blue® Biodegradable Cleaner & Degreaser but without the fragrance. It can be used in all departments of a food processing plant. Contains no ozone-depleting chemicals (ODCs). CFIA approved.

Item #	23811	1 gallon bottle
	20279	55 gallon drum

**Loctite® Aqua Power®
Biodegradable Cleaner & Degreaser**

Penetrates, dissolves and removes dirt and oil. Fast drying and residue-free. Environmentally responsible product is biodegradable, has low toxicity, contains no ozone-depleting chemicals (ODCs), and is noncorrosive/non-caustic.

Item # 30565 17 oz. net wt. aerosol

**Loctite® ODC-Free Cleaner
& Degreaser (Naphtha)**

A non-aqueous, hydrocarbon-based solvent designed for cleaning and degreasing surfaces to be bonded with adhesives, as well as for general-purpose industrial cleaning. Safe on aluminum, rubber and most plastics, and will not cause flash rusting on water-sensitive parts. Dries residue-free. Contains no ozone-depleting chemicals (ODCs). (Formerly referenced as 7070™.) NSF® K1 approved.

Item # 22355 15 oz. net wt. aerosol
20162 16 fl. oz. pump spray
20260 1 gallon can

[Electrical Cleaners]

**Loctite® Electrical Contact
& Parts Cleaner**

Fast-evaporating cleaner removes grease, oil and other contaminants from electrical parts and mechanical equipment. Contains no CFCs or HCFCs and is safe on most plastics. Nonconductive and noncorrosive.

Item # 25791 11 oz. net wt. aerosol

**Loctite® Electrical
Contact Cleaner**
NONFLAMMABLE

Removes grease, oil and other contaminants from electrical parts to prevent contact failure. Dries residue-free in seconds. Nonconductive, noncorrosive, nonflammable. Contains no CFCs or Class I ozone-depleting chemicals (ODCs). Contains HCFC-141b. May attack some sensitive plastics.

Item # 1174633 12 oz. net wt. aerosol

Sources REVEALED



□ [Applications]

- Pump
- Gearbox
- Concrete Repair
- Conveyor Systems
- Shaft Repair

[Industries]

- Mining
- Wastewater
- Power Generation

- Food Processing
- Pulp and Paper
- Beverage

APPLICATIONS
& INDUSTRIES

[Paint Stripper]

Source's PICK

Loctite® Chisel® Paint Stripper (Methylene Chloride)

PAINT STRIPPER/GASKET REMOVER

Removes gaskets from any type of assembly in 10 to 15 minutes. Prepares metal parts for new gaskets, eliminating scraping and sanding. Works on wood; noncorrosive on aluminum. Not for use on plastics, linoleum or synthetic fibers. CFIA approved.

Item # 79040 18 oz. net wt. aerosol

Loctite® Chisel® MC-Free Paint Stripper

PAINT STRIPPER/GASKET REMOVER

Free of Methylene Chloride, Loctite® Chisel® MC-Free Paint Stripper has a foaming action that lifts off gaskets from any type of assembly in minutes. Performs better than Methylene Chloride formulations on silicone gaskets and removes most spray paints from steel panels in less than 30 seconds. Convenient spray liquid penetrates and cleans intricate shapes and will not run off, even on vertical surfaces. Suitable for wood and plaster. Not for use on plastics, linoleum or synthetic fibers.

Item # 1317781 15.25 oz. net wt. aerosol

[Glass Cleaner / Hand Wipes]

Source's PICK

Loctite® Industrial Hand Wipes

Pre-moistened with a powerful citrus-scented cleaning formula that is abrasive enough to scrub off the toughest grease and grime. Quick and easy-to-use, these 9.5 in. x 12 in. towels eliminate rinsing and drying and leave no residue behind. Perfect for industrial and commercial environments in the painting, printing, maintenance, transportation and construction industries.

Item # 34943 75 count canister
34944 130 count bucket

[Parts Cleaners]

Loctite® Non-Chlorinated Parts Cleaner

Penetrates, dissolves, and removes dirt and oil from metal parts. Leaves no residue. Does not contain 1,1,1-trichloroethane; helps manage EPA halide limits.

Item # 30545 14.75 oz. net wt. aerosol

Source's PICK

Loctite® Pro Strength Parts Cleaner

Aggressively penetrates, dissolves and removes oil and grease from parts. Dries quickly with no residue. Contains no ozone-depleting chemicals (ODCs).

Item # 30548 19 oz. net wt. aerosol

Loctite® 768™ X-NMS Cleanup Solvent

Quickly and safely dissolves cured cyanoacrylate-based adhesives.

Item # 76820 1.75 fl. oz. bottle
76871 1 gallon can

[Stripper / Varnish Remover]

Loctite® Pro Strength Varnish Remover

Super jet spray quickly cuts and removes grease, gum and varnish from chokes, baffle plates and carburetor linkage. Improves performance and fuel efficiency.

Item # 30529 12 oz. net wt. aerosol



- The Loctite® line of cleaners and degreasers includes both aqueous and solvent-based products, all of which are free of Class I ozone-depleting chemicals (ODCs).

HELPFUL HINTS

Your Source for
SURFACE PREPARATION
**CLEANERS
& DEGREASERS**

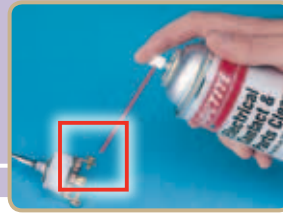

[Loctite® Cleaners & Degreasers Properties Chart]

	LOCTITE® PRODUCT	ITEM NUMBER	PACKAGE TYPE & SIZE	DRYING TIME	RESIDUE/RINSABILITY	ODOR
DEGREASERS	NATURAL BLUE® BIODEGRADABLE CLEANER & DEGREASER	82244 82249 82251 82253 82254 82255	4 fl. oz. bottle 24 fl. oz. spray bottle 1 gallon bottle 5 gallon pail 15 gallon pail 55 gallon drum	Equivalent to the evaporation rate of water. Wiping or blowers will accelerate dry time.	Rinses residue-free with water	Pine Scent
	NATURAL BLUE® BIODEGRADABLE CLEANER & DEGREASER (FRAGRANCE-FREE)	23811 20279	1 gallon bottle 55 gallon drum	Equivalent to the evaporation rate of water. Wiping or blowers will accelerate dry time.	Rinses residue-free with water	Fragrance-Free
	AQUA POWER® BIODEGRADABLE CLEANER & DEGREASER	30565	17 oz. net wt. aerosol	5 to 15 minutes	No rinse and no residue	Mild Citrus
	ODC-FREE CLEANER & DEGREASER	22355 20162 20260	15 oz. net wt. aerosol 16 fl. oz. pump spray 1 gallon can	Equivalent to the evaporation rate of water. Wiping or blowers will accelerate dry time.	No rinse and no residue	Mild Citrus
ELECTRICAL CLEANERS	ELECTRICAL CONTACT & PARTS CLEANER	25791	11 oz. net wt. aerosol	<30 seconds	No rinse and no residue	Mild Solvent
	ELECTRICAL CONTACT CLEANER (NONFLAMMABLE)	1174633	12 oz. net wt. aerosol	<30 seconds	No rinse and no residue	Mild Solvent
PAINT STRIPPER	CHISEL® PAINT STRIPPER (METHYLENE CHLORIDE)	79040	18 oz. net wt. aerosol	Leave on surface for 5 to 10 minutes. Wipe/scrape clean.	Waxy residue	Solvent
	CHISEL® MC-FREE PAINT STRIPPER	1317781	15.25 oz. net wt. aerosol	Leave on surface for 5 to 10 minutes. Wipe/scrape clean.	Oily residue	Solvent
GLASS CLEANER / HAND WIPES	INDUSTRIAL HAND WIPES	34943 34944	75 count canister 130 count bucket	1 to 5 minutes	No rinse and no residue	Mild Citrus
PARTS CLEANERS	NON-CHLORINATED PARTS CLEANER	30545	14.75 oz. net wt. aerosol	5 to 15 minutes	No rinse and no residue	Mild Solvent
	PRO STRENGTH PARTS CLEANER	30548	19 oz. net wt. aerosol	5 to 15 minutes	No rinse and no residue	Mild Solvent
	768™ X-NMS CLEANUP SOLVENT	76820 76871	1.75 fl. oz. bottle 1 gallon can	<30 seconds	No rinse and no residue	Solvent
STRIPPER / VARNISH REMOVERS	PRO STRENGTH VARNISH REMOVER	30529	12 oz. net wt. aerosol	5 minutes	No rinse and no residue	Aromatic

ITEMS IN RED = Source's PICK or NEW

[Loctite® Cleaners & Degreasers Application Chart]

	LOCTITE® PRODUCT	FUNCTION	APPLICATION
DEGREASERS	NATURAL BLUE® BIODEGRADABLE CLEANER & DEGREASER	Removes grease, grime, oil, soot, cutting fluids, mildew, stains, light carbon, animal fat, polishing compounds and ink.	Cleans engine parts, ovens, exhaust hoods, drilling rigs. Can be diluted for general wipe-down cleaning. Formulated for pressure spraying and immersion cleaning processes, at room temperature or heated.
	NATURAL BLUE® BIODEGRADABLE CLEANER & DEGREASER (FRAGRANCE-FREE)	Removes grease, grime, oil, soot, cutting fluids, mildew, stains, light carbon, animal fat, polishing compounds and ink, without added fragrance.	Exhaust hoods, machinery, tanks, motors, concrete floors, asphalt, walls, floors, carpets, valves, equipment, vehicles, compressors, exterior siding, engines, bearings.
	AQUA POWER® BIODEGRADABLE CLEANER & DEGREASER	Biodegradable cleaner for removing oil, grease and asphalt.	All-purpose metal parts cleaner.
	ODC-FREE CLEANER & DEGREASER	Removes grease, oil, lubrication fluids, metal cuttings and filings from parts, equipment and machinery.	Use as a spray or in immersion cleaning processes, at room temperature or heated. Recommended as a final pre-assembly cleaning treatment for all surfaces bonded with adhesives.
	PRO STRENGTH DEGREASER	Self-emulsifying degreaser that quickly cuts and removes grease, oil and dirt, as well as inhibiting rust and corrosion.	Cleaning and degreasing industrial and farm equipment, lawn mowers, garage floors, tools.
ELECTRICAL CLEANERS	ELECTRICAL CONTACT & PARTS CLEANER	Removes grease, dirt, oil, flux and surface contaminants from sensitive electrical/electronic devices. Also used for equipment requiring nonconductive, low residue degreasing agents.	Switches, relays, motor controls, pc boards, connectors, tape heads, sensors, control panels, electrically driven equipment, general parts degreasing.
	ELECTRICAL CONTACT CLEANER (NONFLAMMABLE)	Removes grease, dirt, oil, flux and surface contaminants from sensitive electrical/electronic devices. Also used for equipment requiring nonconductive, low residue degreasing agents. Contains HCFC-141b. Nonflammable.	Switches, relays, motor controls, pc boards, connectors, tape heads, sensors, control panels, electrically driven equipment.
PAINT STRIPPER	CHISEL® PAINT STRIPPER (METHYLENE CHLORIDE)	Removes pre-cut conventional gasket cements as well as formed-in-place chemical gaskets.	Removes silicones, baked-on gaskets, gaskets from aluminum, small difficult-to-reach components, weather-stripping adhesive, dried oil, grease, paint, varnish.
	CHISEL® MC-FREE PAINT STRIPPER	Removes pre-cut conventional gasket cements as well as formed-in-place chemical gaskets.	Removes silicones, baked-on gaskets, gaskets from aluminum, small difficult-to-reach components, weather-stripping adhesive, dried oil, grease, paint, varnish.
GLASS CLEANER/ HAND WIPES	INDUSTRIAL HAND WIPES	Removes grease, grime, oil, soot, paints and ink.	Removes grease, grime, oil, soot, paints and ink from surfaces. Removes grease and grime from hands.
PARTS CLEANERS	NON-CHLORINATED PARTS CLEANER	Cleaner for removing oil, grease and asphalt with no chlorinated solvent runoff.	All-purpose metal parts cleaner. Ideal for aluminum surfaces.
	PRO STRENGTH PARTS CLEANER	Removes oil, grease, brake fluids, oxidized oils (gum) and asphalt. Penetrates through dirt and corrosion and flushes them away.	All-purpose metal parts cleaner.
	768™ X-NMS CLEANUP SOLVENT	Dissolves cured cyanoacrylate-based adhesives.	Disassembly of parts and cleanup of dispensing equipment.
STRIPPER/VARNISH REMOVERS	PRO STRENGTH VARNISH REMOVER	Dissolves and cleans residue deposited during normal operation of gasoline engine powered equipment.	Carburetors, chokes, linkages, heat risers, PCV valves, metal parts, industrial equipment.

ITEMS IN RED = Source's PICK or NEW

Your Source for
SURFACE PREPARATION
PRIMERS, ACTIVATORS
& ACCELERATORS



- Accelerators increase the cure speed and gap-filling capabilities of cyanoacrylate adhesives
- Activators are specially engineered curing agents for structural adhesives
- Primers are used to ensure the cure of inactive surfaces and speed the cure of machinery adhesives
- Available in ozone-safe (non-chlorofluorocarbons), solvent-based and solventless formulations

[Accelerators]

Loctite® 7113™ Accelerator

This accelerator features long on-part life. Use with Loctite® cyanoacrylate adhesives.

Item #	19605	1.75 fl. oz. bottle
	19606	1 gallon can

Loctite® 7452™ Tak Pak® Accelerator

This accelerator, with aggressive cleaning properties, promotes the cure speed of all Loctite® cyanoacrylate adhesives.

Item #	18490	1.75 fl. oz. brush-top bottle
	18580	1.75 fl. oz. spray-cap bottle
	18637	0.7 fl. oz. metered mist
	18575	1 quart can
	18576	1 gallon can

[Activators]

Loctite® 7075™ Activator

An acetone-based activator that promotes the proper cure of Loctite® 324™ and 325™ Speedbonder™ Structural Adhesives.

Item #	21349	1 quart can
	22671	4.5 oz. net wt. aerosol can

Loctite® 7380™ Depend® Activator

This solvent-free activator allows immediate mating of parts. Use with most Loctite® acrylic adhesives.

Item #	19822	1 liter can
	19824	1.75 fl. oz. bottle
	19907	1 gallon

Loctite® 7387™ Depend® Activator

This activator promotes the cure of most Loctite® acrylic adhesives. This is a flammable product.

Item #	18861	1.75 fl. oz. bottle
	18862	1 quart can
	21088	4.5 oz. net wt. aerosol can

Loctite® A-534R™ Activator

(formerly National Adhesives Bondmaster™ 534R Activator)

This solvent-free activator contains red dye to enhance visual detection when applied. Use with Loctite® A-533™ Acrylic Adhesive.

Item #	1254434	1 quart bottle
	1254435	4 oz. bottle

[Primers]

Loctite® 770™ Prism® Primer

An adhesion promoter formulated for use with polyolefins and other low surface energy plastic materials. Use with Loctite® cyanoacrylate adhesives. Fast dry time and long on-part life.

Item #	18396	1.75 fl. oz. bottle
	18397	16 fl. oz. can

Loctite® 7088™ QuickStix® Primer

Semisolid, solventless primer. Very long on-part life speeds the cure of anaerobic products. Eliminates potential spills. Works well with structural bonders.

Item #	1069258	17 g stick
--------	---------	------------

Loctite® 7471™ Primer T™

A solvent-based primer that speeds the cure of all Loctite® anaerobic adhesives and ensures proper cure on inactive metals.

Item #	19267	1.75 fl. oz. bottle
	22477	4.5 oz. net wt. aerosol can
	19268	1 gallon can

Loctite® 7649™ Primer N™

A solvent-based primer that features very long on-part life. Use to speed the cure of all Loctite® anaerobic products and ensure proper cure on inactive metals. Ideal for cure conditions below room temperature.

Item #	19269	1.75 fl. oz. glass bottle
	21347	25 g net wt. aerosol can
	21348	4.5 oz. net wt. aerosol can
	19266	1 gallon can

Loctite® 7951™ Prism® Primer

A nonflammable and noncombustible adhesion promoter formulated for use with polyolefins and other low surface energy plastic materials. Use with Loctite® cyanoacrylate adhesives. Fast dry time and long on-part life.

Item #	27858	1.75 fl. oz. bottle
	1354770	16 fl. oz. can

LOCTITE® PRODUCT		ITEM NUMBER	TYPE	VISCOSITY RANGE	DISPENSE PATTERNS	USED TO DISPENSE	STROKE ADJUSTMENT	SUCK-BACK	CONSUMABLES – DISPENSE ACCESSORIES
VALVES AND PUMPS	SPRAY VALVES								
	 LOCTITE® SPRAY VALVE	98520	Spray Valve	Low	Spray	Primers, Activators, Accelerators	Yes	No	Dispense Tips and Accessories – Pages 184-188

ADDITIONAL RESOURCES

Sources REVEALED

WHEN SHOULD I USE A LOCTITE® PRIMER?

Speed up cure – Significantly speed up the cure time of Loctite® threadlockers when assembling metal parts that are cold, have large gaps or deep threads.

Inactive metal assemblies* – When assembling metal parts with inactive surfaces, Loctite® primers are recommended to ensure proper performance of Loctite® threadlockers.

Please note: Loctite® Anaerobic Machinery Adhesives cure in the absence of air and presence of metal ions. When assembling inactive metal parts, which are low in metal ions, the use of Loctite® Primers are recommended to ensure proper performance of Loctite® Anaerobic Machinery Adhesives.

INACTIVE METALS* (PRIMERS RECOMMENDED)		ACTIVE METALS (PRIMERS OPTIONAL)
PLATED PARTS	SILVER	IRON
ANODIZED ALUMINUM (ALODINE, IRRIDITE)	GOLD	PLAIN STEEL
TITANIUM	ZINC	COPPER
STAINLESS STEEL	PURE	BRASS
GALVANIZED STEEL	ALUMINUM	BRONZE
MAGNETITE STEEL	CADMIUM	MANGANESE
ICONEL®	MAGNESIUM	MONEL®
	NATURAL OR CHEMICAL BLACK OXIDE	KOVAR®

HELPFUL HINTS



[Loctite® Primers, Activators & Accelerators Properties Chart]

LOCTITE® PRODUCT	ITEM	PACKAGE TYPE & SIZE	COLOR	VISCOSITY (cP)	BASE	ON-PART LIFE	DRY TIME	APPLICATION	AGENCY APPROVALS	
ACCELERATORS	712™ TAK PAK®	20352 18636 18390	1.75 fl. oz. bottle 0.7 fl. oz. metered mist 1 gallon can	Clear/ Amber	1	Isopropanol	1 minute	<30 seconds	All cyanoacrylates	MIL-46050C for existing designs, CFIA
	7109™ TAK PAK® II	22440 23034	1.75 fl. oz. bottle 1 quart can	Clear/ Amber	3	Perfluorocarbon	1 minute	<5 seconds	All cyanoacrylates	N/A
	7113™	19605 19606	1.75 fl. oz. bottle 1 gallon can	Clear	0.4	Heptane	24 hours	1 minute	All cyanoacrylates	N/A
	7452™ TAK PAK®	18490 18580 18637 18575 18576	1.75 fl. oz. brush-top bottle 1.75 fl. oz. spray-cap bottle 0.7 fl. oz. metered mist 1 quart can 1 gallon can	Clear/ Amber	0.4	Acetone	1 minute	<30 seconds	All cyanoacrylates	MIL-46050C for existing designs
ACTIVATORS	7075™	21349 22671	1 quart can 4.5 oz. net wt. aerosol can	Amber	2	Acetone	2 hours	3 minutes	324™ or 325™	N/A
	7380™ DEPEND®	19822 19824 19907	1 liter can 1.75 fl. oz. bottle 1 gallon	Light Brown	43	No solvent	2 hours	None	Structurals	N/A
	7387™ DEPEND®	18861 18862 21088	1.75 fl. oz. bottle 1 quart can 4.5 oz. net wt. aerosol can	Light Brown	1.5	Heptane/ Isopropanol	2 hours	None	Structurals	N/A
	ANAEROBIC ACTIVATOR	25062	1 liter bottle	Thin Green/ Fluorescent	1.03	No solvent	1 hour	None	Anaerobics on dichromate surfaces	N/A
	A-534R™	1254434 1254435	1 quart bottle 4 oz. bottle	Red	<50	No solvent	30 minutes	None	A-533™ Acrylic	N/A
PRIMERS	770™ PRISM®	18396 18397	1.75 fl. oz. bottle 16 fl. oz. can	Colorless	1.25	Heptane	8 hours	30 seconds	All cyanoacrylates	CFIA
	7088™ QUICKSTIX® PRIMER	1069258	17 g stick	Teal	Semisolid	No solvent	30 days	None	Anaerobics	N/A
	7090™	19368 12695	1 fl. oz. bottle 1 liter bottle	Dark Blue	17.5	No solvent	1 hour	<10 minutes	Anaerobics	N/A
	7471™ PRIMER T™	19267 22477 19268	1.75 fl. oz. bottle 4.5 oz. net wt. aerosol can 1 gallon can	Amber	2	Acetone/Isopropanol	7 days	30 to 70 seconds	Anaerobics	MIL-S-22473E for existing designs, ASTM D-5363 for new designs
	7649™ PRIMER N™	19269 21347 21348 19266	1.75 fl. oz. glass bottle 25 g net wt. aerosol can 4.5 oz. net wt. aerosol can 1 gallon can	Clear/Green	2	Acetone	30 days	30 to 70 seconds	Anaerobics	MIL-S-22473E for existing designs, ASTM D-5363 for new designs, NSF/ANSI 61, NSF® P1, CFIA
	7951™ PRISM®	27858 1354770	1.75 fl. oz. bottle 16 fl. oz. can	Colorless, Slightly Hazy	0.7	Perfluorocarbon and Chlorobenzotrifluoride	8 hours	30 seconds	All cyanoacrylates	N/A

🌐 = Indicates Worldwide Availability

Your Source for
THREADLOCKING



[Table of Contents]

THREADLOCKING	141
THREADLOCKERS	143
THREADLOCKERS & THREAD SEALANTS EQUIPMENT	155

THREADLOCKERS

Loctite® threadlockers are vastly superior to mechanical locking devices for the assembly of threaded fasteners. The anaerobic liquid is applied drop-wise to the threads of a fastener and cures to a hard thermoset plastic that locks the threads together. This prevents unwanted movement, loosening, leaks and/or corrosion. To further enhance their performance, anaerobic formulations have been developed for applications with high temperatures, oil contamination and less active surfaces.

Loctite® threadlockers have historically been formulated as liquids due to their reactivity; in liquid form they remain stable and ready for use. Recent breakthroughs have led to the development of stable, semisolid stick formulations. This has opened the door to applications where the liquids were considered too messy or inconvenient. The new semisolid formulations allow direct contact of the anaerobic product to the part – the product is placed exactly where it is needed, and it stays in place as the threaded part is positioned and assembled.

Threaded fasteners continually receive various types of differential stress. Stresses, such as vibration and shock, thermal expansion and contraction, and micro-movement of the fastened parts, can all reduce clamping force and ultimately cause machine failure. Many mechanical devices, such as spring washers, wire retainers and locking bolts, were developed to prevent uncontrolled loosening of fasteners. These locking methods add substantial cost to the fastener assembly, yet cannot reliably prevent loosening due to their uneven side or sliding motion. They also do not seal or prevent corrosion within the fastener assembly and must be sized appropriately for the specific fastener.

Threadlockers are available in low strength formulations for easy removal, medium strength grades that are removable using common hand tools, and high strength grades that offer strong holding abilities. However, no threadlocker is completely permanent; standard hand tools remove even the highest-strength threadlockers following direct exposure to heat (450°F to 500°F) for about five minutes.

CAN I RE-USE BOLTS THAT WERE PREVIOUSLY LOCKED WITH THREADLOCKER?

Any bolt previously locked with threadlocking adhesive is reusable simply by removing the old adhesive, applying new threadlocking material and reassembling.

Loctite® Adhesives and Sealants Product Specialists are available to assist you with new product designs, or to help you re-engineer an existing application for improved performance and cost savings. They can also set up testing of your parts at the Henkel Customer Engineering Center. For application assistance, call **1-800-LOCTITE (562-8483)**; *within Canada, call 1-800-263-5043*; or contact us through the web at www.henkelna.com/loctite.

STRAIGHT FROM *The Source*

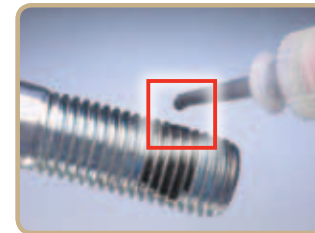

Your Source THREADLOCKING SELECTOR GUIDE

WHAT TYPE OF METAL PARTS ARE BEING ASSEMBLED?

Inactive Metals (Metals that don't rust)	Active Metals (Metals that rust)	
	Are the parts pre-assembled?	
	YES	NO
Loctite® 243™ Blue Threadlocker Item.# 1330255 0.5 ml capsule 1329837 10 ml bottle 1329467 50 ml bottle 1329505 250 ml bottle 1330333 1 liter bottle PRIMERLESS / MEDIUM STRENGTH	UP TO 300°F (150°C) Loctite® 220™ Threadlocker Item.# 37388 10 ml bottle 39186 50 ml bottle 22041 250 ml bottle WICKING / MEDIUM STRENGTH	HIGH TEMPERATURE UP TO 450°F (232°C) Loctite® 246™ Threadlocker Item.# 29513 10 ml bottle 29514 50 ml bottle 29515 250 ml bottle MEDIUM STRENGTH
	Loctite® 263™ Red Threadlocker Item.# 1330582 0.5 ml capsule 1330583 10 ml bottle 1330585 50 ml bottle 1330335 250 ml bottle 1330334 1 liter bottle PRIMERLESS / HIGH STRENGTH	Loctite® 290™ Threadlocker Item.# 29005 0.5 ml capsule 29021 10 ml bottle 29031 50 ml bottle 29041 250 ml bottle 29043 1 liter bottle WICKING / HIGH STRENGTH
	300°F (150°C) TO 450°F (232°C) Loctite® 294™ Threadlocker Item.# 27935 10 ml bottle 27936 50 ml bottle 27937 250 ml bottle WICKING / HIGH TEMPERATURE	Loctite® 266™ Threadlocker Loctite® 272™ Threadlocker Item.# 266™ 26772 10 ml bottle 266™ 26773 50 ml bottle 266™ 26774 250 ml bottle 272™ 27240 50 ml bottle 272™ 27270 250 ml bottle 272™ 27285 1 liter bottle HIGH STRENGTH
		UP TO 650°F (343°C) Loctite® 2422™ Threadlocker Item.# 1134601 30 g syringe 1134602 300 g cartridge HIGH TEMPERATURE / MEDIUM STRENGTH
		Loctite® 2620™ Threadlocker Item.# 1138282 30 g syringe HIGH TEMPERATURE / HIGH STRENGTH
		Loctite® 243™ Blue Threadlocker Item.# 1330255 0.5 ml capsule 1329837 10 ml bottle 1329467 50 ml bottle 1329505 250 ml bottle 1330333 1 liter bottle PRIMERLESS / MEDIUM STRENGTH
		Loctite® 263™ Red Threadlocker Item.# 1330582 0.5 ml capsule 1330583 10 ml bottle 1330585 50 ml bottle 1330335 250 ml bottle 1330334 1 liter bottle PRIMERLESS / HIGH STRENGTH
		Loctite® QuickTape® 249™ Blue Threadlocker Tape Item.# 1372603 260 in. Roll MEDIUM STRENGTH
		SEMISOLID/GEL Loctite® QuickStix® 248™ Blue Threadlocker Item.# 37684 9 g stick 37087 19 g stick MEDIUM STRENGTH
		Loctite® QuickStix® 268™ Threadlocker Item.# 37685 9 g stick 37686 19 g stick HIGH STRENGTH

Your Source for **THREADLOCKING** **THREADLOCKERS**

- Prevents loosening from shock and vibration
- Single component – clean and easy to apply
- Can be used on various sizes of fasteners – reduces inventory costs
- Seals threads
- Stops rust and corrosion
- Available in a variety of viscosities and strengths for virtually any application



WHEN SHOULD I USE A LOCTITE® PRIMER?

Speed up cure – Significantly speed up the cure time of Loctite® threadlockers when assembling metal parts that are cold, have large gaps or deep threads.

Inactive metal assemblies* –

When assembling metal parts with inactive surfaces, Loctite® primers are recommended to ensure proper performance of Loctite® threadlockers.

Please note: Loctite® Anaerobic Machinery Adhesives cure in the absence of air and presence of metal ions. When assembling inactive metal parts, which are low in metal ions, the use of Loctite® Primers are recommended to ensure proper performance of Loctite® Anaerobic Machinery Adhesives.

INACTIVE METALS* (PRIMERS RECOMMENDED)		ACTIVE METALS (PRIMERS OPTIONAL)
PLATED PARTS	SILVER	IRON
ANODIZED ALUMINUM (ALODINE, IRRIDITE)	GOLD	PLAIN STEEL
TITANIUM	ZINC	COPPER
STAINLESS STEEL	PURE	BRASS
GALVANIZED STEEL	ALUMINUM	BRONZE
MAGNETITE STEEL	CADMIUM	NICKEL
ICONEL®	MAGNESIUM	MANGANESE
	NATURAL OR CHEMICAL BLACK OXIDE	MONEL®
		KOVAR®

HELPFUL HINTS

THREADLOCKING

- Clean parts with Loctite® ODC-Free Cleaner & Degreaser before applying the adhesive.
- If the threadlocker will be applied below 40°F, pre-treat with Loctite® 7649™ Primer N™.
- If the parts were in contact with aqueous washing solutions or cutting fluids, which leave a protective layer on the surface, wash with hot water before use.

HELPFUL HINTS

Is there a threadlocker for high temperature applications?

Yes, Henkel has threadlockers for applications below 300°F (150°C) and between 300°F (150°C) to 650°F (343°C). One example is Loctite® 2422™, a medium strength product for temperatures up to 650°F (343°C). Other high temperature products can be found in the Properties Chart.

Are there products that work well on oily parts?

There are several Loctite® products with oil-cutting capabilities. These include Loctite® 243™, 246™, 263™, 266™ and 294™ threadlockers. Use the Properties Chart to choose the one that is right for your application.

What do I do when I have a blind hole application?

The application method for blind hole assemblies requires that the product be applied to both parts. If the product is applied to the fastener only, air pressure will force the liquid threadlocker to escape as you torque down.

Do you have a product for inactive metals?

Loctite® 243™, 263™ and 2760™ threadlockers enable the assembly of inactive metals without the need to use a primer. These products are ideal for use on metals such as stainless steel, zinc, magnesium, black oxide, cadmium, anodized aluminum, passivated titanium and others.

How much time is needed for the adhesive to cure?

Most anaerobic adhesives attain full cure in around 24 hours but will fixture in less time. For cure speed of the various products, refer to the Properties Chart or to the Technical Data Sheets (TDS).

Can I use threadlockers on plastic threads?

For plastic fasteners, only use Loctite® 425™ Assure™ Instant Adhesive, a surface curing threadlocker.

When should I use a primer?

Primers help speed the curing process for faster return to service. For this reason, they can be used in any application but are most often used on less active metal surfaces. Alternatively, the use of Loctite® 243™ and 263™ primerless products provides a fast cure on inactive surfaces.

The Source ANSWERS YOUR QUESTIONS

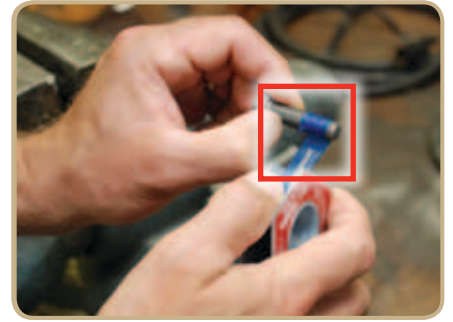

[Industries]

- Manufacturing
- Maintenance and Repair

[General-Purpose]

Source's PICK

Loctite® 243™ Blue Threadlocker MEDIUM STRENGTH/PRIMERLESS

A general-purpose, medium strength threadlocker with improved temperature resistance. Does not require most fasteners to be pre-cleaned or primed before use. Suitable for 1/4 in. to 3/4 in. diameter (6 mm to 20 mm) fasteners.

Item #	1330255	0.5 ml capsule	Item #	1329505	250 ml bottle
	1329837	10 ml tube		1330333	1 liter bottle
	1329467	50 ml bottle			

Loctite® QuickStix® 248™ Blue Threadlocker

SEMISOLID/MEDIUM STRENGTH

Patented semisolid stick formula won't spill or leak for added convenience and portability. Like Loctite® 242®, this is suited for 1/4 in. to 3/4 in. (6 mm to 20 mm) fasteners and is removable with hand tools.

Item #	37684	9 g stick
	37087	19 g stick

Source's PICK

Loctite® QuickTape® 249™ Blue Threadlocker Tape

TAPE/MEDIUM STRENGTH

The one and only threadlocker in a tape form. This revolutionary product offers the same reliability and performance as Loctite® removable grade threadlocking liquids. Convenient, durable package is a must for every toolbox. It is easy to apply and can be reapplied for future assembly.

Item #	1372603	260 in. Roll
--------	---------	--------------

Source's PICK

Loctite® 263™ Red Threadlocker HIGH STRENGTH/PRIMERLESS

A general-purpose, high strength threadlocker with improved temperature resistance. Does not require most fasteners to be pre-cleaned or primed before use. Locks fasteners up to 1 in. (25 mm).

Item #	1330582	0.5 ml capsule
	1330583	10 ml bottle
	1330585	50 ml bottle
	1330335	250 ml bottle
	1330334	1 liter bottle

Loctite® QuickStix® 268™ Threadlocker – High Strength

SEMISOLID/RED

Revolutionary semisolid stick formula is high strength and best suited for fasteners up to 3/4 in. (20 mm). Semisolid formula offers added convenience and portability. Localized heat and hand tools are required to separate parts.

Item #	37685	9 g stick
	37686	19 g stick

Source's PICK

Loctite® 290™ Threadlocker

WICKING GRADE/HIGH STRENGTH/GREEN

A low viscosity, high strength threadlocker for pre-assembled bolts up to 1/2 in. (12 mm) to secure them in place. Penetrates threads by capillary action. Seals porosities in welds and metal parts. Secures set screws and other assemblies after settings are completed. Protects threads from rust and corrosion. Localized heating and hand tools are needed for disassembly.

Item #	29005	0.5 ml capsule
	29021	10 ml bottle
	29031	50 ml bottle
	29041	250 ml bottle
	29043	1 liter bottle

Loctite® 294™ Threadlocker

WICKING GRADE/HIGH TEMPERATURE

Ideally suited for pre-assembled fasteners. Performs well on oily fasteners.

Item #	27935	10 ml bottle
	27936	50 ml bottle
	27937	250 ml bottle
	27944	1 liter bottle

[Speciality]

Loctite® 246™ Threadlocker

MEDIUM STRENGTH/ HIGH TEMPERATURE

This threadlocker resists oil and mild surface contamination at continuous temperatures to 450°F. Suitable for 1/4 in. to 3/4 in. dia. (6 mm to 20 mm) fasteners.

Item #	29513	10 ml bottle
	29514	50 ml bottle
	29515	250 ml bottle

Loctite® 2046™ Threadlocker

FOOD COMPLIANT

Withstands temperatures to 400°F (204°C). Removable strength for easy service. Prevents galling and seizing. Primerless for stainless steel applications. Suitable for use on food equipment.

Item #	1186840	0.40 fl. oz. (12 ml)
--------	---------	----------------------

Loctite® 2400NA™ Blue Threadlocker

MEDIUM STRENGTH

Formulated to enhance health and safety. General-purpose threadlocking adhesive for fasteners 1/4 in. to 3/4 in. (6 mm to 20 mm). Removable strength allows fasteners to be disassembled with standard hand tools.

Item #	1526121	50 ml bottle
	1626122	250 ml bottle

Your Source for **THREADLOCKING
THREADLOCKERS**

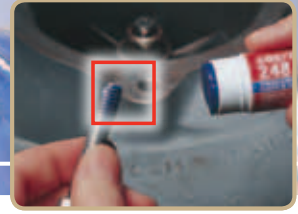

Loctite® 2422™ Threadlocker

MEDIUM STRENGTH

Lock and seal threaded fasteners in applications that require continuous temperature resistance of up to 650°F (343°C).

- Item # 1134601 30 g syringe
- 1134602 300 g cartridge

Loctite® 2423™ Threadlocker

LOW ODOR/MEDIUM STRENGTH

Low odor formula for applications where odor may be an issue.

- Item # 1134871 50 ml bottle

Loctite® 2432™ Threadlocker

LOW HALOGEN/LOW SULFUR

This medium strength threadlocker was specially developed for use on sensitive metals, like titanium, used in the nuclear industry.

- Item # 25523 50 ml bottle

Loctite® 266™ Threadlocker

**HIGH STRENGTH/
HIGH TEMPERATURE**

Fast fixturing threadlocker resists oil and mild surface contamination at temperatures to 450°F (232°C). Locks fasteners up to 3/4 in. (20 mm) in diameter.

- Item # 26772 10 ml bottle
- 26773 50 ml bottle
- 26774 250 ml bottle

Loctite® 272™ Threadlocker

HIGH STRENGTH/HIGH TEMPERATURE

Withstands temperatures to 450°F (232°C). Provides a fast cure on most surfaces, including “as received” fasteners. Recommended for bolts up to 1 1/2 in. (36 mm) in diameter. Heat and hand tools are required for disassembly.

- Item # 27240 50 ml bottle
- 27270 250 ml bottle
- 27285 1 liter bottle

Loctite® 2047™ Threadlocker

HIGH LUBRICITY/HIGH STRENGTH

Designed for applications on large fasteners over 7/8 in. (22 mm) in diameter. New formula has increased lubricity that reduces friction and allows proper clamp load to be achieved. High strength properties ensure clamp load is maintained when exposed to vibration.

- Item # 1134607 50 ml bottle

Loctite® 2620™ Threadlocker

HIGH STRENGTH

Lock and seal threaded fasteners in applications that require continuous temperature resistance of up to 650°F (343°C).

- Item # 1138282 30 g syringe

Loctite® 2700NA™ Red Threadlocker

HIGH STRENGTH

Formulated to enhance health and safety. General purpose threadlocking adhesive for fasteners up to 3/4 in. (20 mm). High strength formula recommended for permanent assembly. Localized heat and hand tools required for disassembly.

- Item # 1526123 50 ml bottle
- 1526565 250 ml bottle

**Loctite® 425™ Assure™
Instant Adhesive**

**PLASTIC/SURFACE CURING
THREADLOCKER**

Low strength, fast curing threadlocker for plastic fasteners. Can be used as a tamper-proofing agent for the head of screws. Can be applied before or after assembly.

- Item # 42540 20 g bottle
- 42561 1 lb. bottle

[MIL Spec]

Loctite® 222MS™ Threadlocker

LOW STRENGTH/SMALL SCREW/PURPLE

Ideal for fastener diameters of 1/4 in. (6 mm) and smaller, long engagement length fasteners, and components requiring occasional adjustment. Apply to threaded parts before assembly. Controlled lubricity for accurate clamp loads. Parts can be disassembled with hand tools. Approved for use in or around food processing areas.

- Item # 22205 0.5 ml capsule
- 22221 10 ml bottle
- 22231 50 ml bottle
- 22241 250 ml bottle

Loctite® 242® Blue Threadlocker

MEDIUM STRENGTH

Removable strength, general-purpose threadlocking adhesive well suited for fasteners between 1/4 in. to 3/4 in. diameter (6 mm to 20 mm). Applied to threaded components before assembly, Loctite® 242® Threadlocker has controlled lubricity for accurate clamp loads. Parts can be separated using hand tools. Approved for use in or around food processing areas.

- Item # 24205 0.5 ml capsule
- 24221 10 ml tube
- 24231 50 ml bottle
- Item # 24241 250 ml bottle
- 24243 1 liter bottle

Loctite® 262™ Threadlocker

MEDIUM TO HIGH STRENGTH

A permanent, high strength product that is applied to fasteners up to 3/4 in. (20 mm) in diameter before assembly. High lubrication for easy assembly. Excellent for preventing rust and corrosion in extreme chemical/environmental conditions. Localized heat and hand tools are required to separate parts. Solvents will not weaken the adhesive bond. Approved for use in or around food processing areas.

- Item # 26205 0.5 ml capsule
- 26221 10 ml tube
- 26231 50 ml bottle
- 26241 250 ml bottle
- 26243 1 liter bottle

Source's PICK

Loctite® 271™ Threadlocker

HIGH STRENGTH

A high strength, low viscosity threadlocker for fasteners up to 1 in. (25 mm) in diameter.

Item #	27105	0.5 ml capsule
	27121	10 ml bottle
	27131	50 ml bottle
	27141	250 ml bottle
	27143	1 liter bottle

Loctite® 277™ Threadlocker

HIGH STRENGTH

Locks fasteners up to 1 ½ in. (36 mm). Protects threads from rust and corrosion. Removable with heat and hand tools.

Item #	21434	10 ml bottle
	27731	50 ml bottle
	27741	250 ml bottle
	27743	1 liter bottle

Loctite® 220™ Threadlocker

WICKING GRADE/MEDIUM STRENGTH/BLUE

A low viscosity threadlocking adhesive that allows the product to wick along the threads of pre-assembled fasteners. Perfect for fasteners up to 1/4 in. in diameter (6 mm).

Item #	37388	10 ml bottle
	39186	50 ml bottle
	22041	250 ml bottle

Loctite® 290™ Threadlocker

WICKING GRADE/HIGH STRENGTH/GREEN

A low viscosity, high strength threadlocker for pre-assembled bolts up to 1/2 in. (12 mm) to secure them in place. Penetrates threads by capillary action. Seals porosities in welds and metal parts. Secures set screws and other assemblies after settings are completed. Protects threads from rust and corrosion. Localized heating and hand tools are needed for disassembly.

Item #	29005	0.5 ml capsule
	29021	10 ml bottle
	29031	50 ml bottle
	29041	250 ml bottle
	29043	1 liter bottle

Source's PICK

[Primers]

Loctite® 7649™ Primer N™

Decreases the setup time of Loctite® threadlockers and increases breakaway torque on most fastener surfaces. Allows application of threadlockers in cold weather. Contains no ozone-depleting compounds.

Item #	19269	1.75 fl. oz. glass bottle
	21347	25 g net wt. aerosol
	21348	4.5 oz. net wt. aerosol
	19266	1 gallon can

Loctite® 7088™ QuickStix® Primer

Semisolid, solventless primer. Very long on-part life and speeds the cure of anaerobic products. Eliminates potential spills. Works well with structural bonders.

Item #	1069258	17 g stick
--------	---------	------------

HELPFUL HINTS



CHOOSING THE RIGHT THREADLOCKER FOR YOUR APPLICATION

How do I decide which threadlocker to use?

Loctite® threadlockers are available in many grades to satisfy a wide range of applications. To make grade selection easy, the grades are color-coded to help you identify one threadlocker from the other.

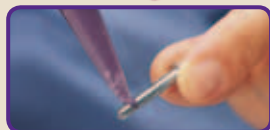

LOW STRENGTH – Purple color, removable with hand tools, good for adjustment screws, calibration screws, meters and gauges, and for fasteners up to 1/4 in. in diameter.



MEDIUM STRENGTH – Blue color, removable with hand tools, good for machine tools and presses, pumps and compressors, mounting bolts, gearboxes, and for fasteners up to 2 in. in diameter. Available in liquid, tape and stick formats.



HIGH STRENGTH – Red color, for permanent assemblies, heavy equipment, suspension bolts, motor and pump mounts, bearing cap bolts and studs, and for fasteners up to 1 in. and larger in diameter.



WICKING – Green color, removable with heat and hand tools, for pre-assembled fasteners, instrumentation screws, electrical connectors, carburetors and fasteners up to 1/2 in. in diameter.

Your Source for **THREADLOCKING
THREADLOCKERS**



[Loctite® General-Purpose Threadlockers Properties Chart]

KEY FACTORS	KEY FEATURES	TYPICAL USE	PRODUCT	ITEM NUMBER	PACKAGE TYPE & SIZE	COLOR	VISCOSITY (cP)†	TORQUE‡ in.-lbs. (break/prevail)	TEMP. RANGE	CURE SPEED (STEEL @ 25°C)	AGENCY APPROVALS	
GENERAL-PURPOSE THREADLOCKERS	Low Strength	Small Fasteners	Small screws under 1/4"	222™	21463 21464	10 ml bottle 50 ml bottle	Purple	1,200 / 5,000 Thixotropic	53 / 30	-65°F to 300°F	Fixture – 20 min. Full – 24 hrs.	N/A
		General-Purpose	1/4" to 3/4" bolts with light oil contamination	243™	1330255 1329837 1329467 1329505 1330333	0.5 ml capsule 10 ml bottle 50 ml bottle 250 ml bottle 1 liter bottle	Blue	1,300 / 3,000 Thixotropic	230 / 40	-65°F to 360°F	Fixture – 10 min. Full – 24 hrs.	NSF®/ANSI 61, CFIA
	Medium Strength	Semisolid Stick	1/4" to 3/4" bolts, overhead, pre-dispensed, hard-to-reach areas	QuickStix® 248™	37684 37087	9 g stick 19 g stick	Blue	Semisolid	110* / 43	-65°F to 300°F	Fixture – 5 min. Full – 24 hrs.	CFIA
		Tape	1/4" to 3/4" bolts, overhead, pre-dispensed, hard-to-reach areas	QuickTape® 249™	1372603	260" roll	Blue	Tape	74 / 47	-65°F to 300°F	Fixture – 30 min. Full – 24 hrs.	N/A
	High Strength	General-Purpose	Primerless, high strength	263™	1330582 1330583 1330585 1330335 1330334	0.5 ml capsule 10 ml bottle 50 ml bottle 250 ml bottle 1 liter bottle	Red	400 / 600	290 / 290*	-65°F to 360°F	Fixture – 5 min. Full – 24 hrs.	CFIA
		Semisolid Stick	Up to 3/4" bolts, overhead, pre-dispensed, hard-to-reach areas	QuickStix® 268™	37685 37686	9 g stick 19 g stick	Red	Semisolid	220* / 34	-65°F to 300°F	Fixture – 5 min. Full – 24 hrs.	CFIA
Wicking Grade	General-Purpose	Medium/High Strength, wicking grade for pre-assembled parts and weld sealing	290™	29005 29021 29031 29041 29043	0.5 ml capsule 10 ml bottle 50 ml bottle 250 ml bottle 1 liter bottle	Green	20 / 55	90 / 260	-65°F to 300°F	Fixture – 20 min. Full – 24 hrs.	MIL-S-46163A for existing designs, ASTM D-5363**, NSF®/ANSI 61, NSF® P1, CFIA	
	General-Purpose	High temperature, wicking grade for pre-assembled fasteners and weld sealing	294™	27935 27936 27937 27944	10 ml bottle 50 ml bottle 250 ml bottle 1 liter bottle	Green	20 / 45	115 / 130	-65°F to 400°F	Fixture – 2 hrs. Full – 24 hrs.	N/A	

[Loctite® Specialty Threadlockers Properties Chart]

KEY FACTORS	KEY FEATURES	TYPICAL USE	PRODUCT	ITEM NUMBER	PACKAGE TYPE & SIZE	COLOR	VISCOSITY (cP)†	TORQUE‡ in.-lbs. (break/prevail)	TEMP. RANGE	CURE SPEED (STEEL @ 25°C)	AGENCY APPROVALS	
SPECIALTY THREADLOCKERS	Medium Strength	High Temperature	High temperature, medium strength	246™	29513 29514 29515	10 ml bottle 50 ml bottle 250 ml bottle	Blue	2,600	170 / 48*	-65°F to 450°F	Fixture – 5 min. Full – 24 hrs.	N/A
		Food Compliant	For use in food & beverage applications	2046™	1186840	0.40 fl. oz. dual cartridge (12 ml)	Blue	Paste	111 / 60	-65°F to 400°F	Fixture – 90 min. Full – 24 hrs.	21 C.F.R. § 175.300
		Enhanced Health & Safety	Removable strength	2400NA™	1526121 1626122	50 ml bottle 250 ml bottle	Blue	3070 Thixotropic	160 / 20	-65°F to 300°F	Fixture – 5 min. Full – 24 hrs.	N/A
		Ultra High Temperature	Ultra high temperature, medium strength for 1/2" to 3/4" bolts	2422™	1134601 1134602	30 g syringe 300 g cartridge	Blue	Paste	102 / 12	-65°F to 650°F	Fixture – 30 min. Full – 24 hrs.	N/A
		Low Odor	Confined spaces / sensitive areas, for 1/4" to 3/4" bolts	2423™	1134871	50 ml bottle	Blue	1,600 Thixotropic	102 / 18	-65°F to 300°F	Fixture – 1 hr. Full – 24 hrs.	N/A
		Low Halogen/ Low Sulfur	For use in nuclear facilities	2432™	25523	50 ml bottle	Blue	300	150 / 53 (black oxide steel nuts and bolts)	-65°F to 300°F	Fixture – 30 min. Full – 24 hrs.	N/A

ITEMS IN RED = Source's PICK or NEW

= Indicates Worldwide Availability

* Break loose value.

** For new designs.

† Brookfield RVT spindle 3.20 RPM/25 RPM.

‡ M10 steel nuts and bolts.

PLEASE NOTE: A complete line of surface primers is available. Refer to the Surface Preparation section.

[Loctite® Specialty Threadlockers Properties Chart]

KEY FACTORS	KEY FEATURES	TYPICAL USE	PRODUCT	ITEM NUMBER	PACKAGE TYPE & SIZE	COLOR	VISCOSITY (cP)†	TORQUE‡ in.-lbs. (break/prevail)	TEMP. RANGE	CURE SPEED (STEEL @ 25°C)	AGENCY APPROVALS
SPECIALTY THREADLOCKERS	High Strength	High Temperature	266™	26772 26773 26774	10 ml bottle 50 ml bottle 250 ml bottle	Red-Orange	3,750 to 9,000 Thixotropic	270 / 75	-65°F to 450°F	Fixture – 10 min. Full – 24 hrs.	CFIA
		High Temperature	272™ 	27240 27270 27285	50 ml bottle 250 ml bottle 1 liter bottle	Red	9,500	200 / 220	-65°F to 450°F	Fixture – 1 hr. Full – 24 hrs.	CFIA
		High Lubricity (Large Bolts)	2047™	1134607	50 ml bottle	Black	2,000 / 12,000 Thixotropic	375 / 80	300°F	Fixture – 90 min. Full – 24 hrs.	N/A
		Ultra High Temperature	2620™	1138282	30 g syringe	Red	Paste	161 / 10	-65°F to 650°F	Fixture – 30 min. Full – 24 hrs.	N/A
		Enhanced Health & Safety	2700NA™	1526123 1526565	50 ml bottle 250 ml bottle	Red	5,000 Thixotropic	300 / 265	-65°F to 300°F	Fixture – 5 min. Full – 24 hrs.	N/A
	Fast Cure/High Strength	2760™	37266 32526 32525 32527 32528	0.5 ml capsule 10 ml bottle 50 ml bottle 250 ml bottle 1 liter bottle	Red	1,250 / 4,250 Thixotropic	325 / 320	-65°F to 300°F	Fixture – 4 min. Full – 24 hrs.	CFIA	
Plastic	Plastic Fasteners	For small metal and plastic fasteners and tamper-proofing	425™ Assure™	42540 42561	20 g bottle 1 lb. bottle	Blue	80	4 / 2	-65°F to 180°F	Fixture – 1.5 min. Full – 24 hrs.	N/A

[Loctite® MIL Spec Threadlockers Properties Chart]

KEY FACTORS	TYPICAL USE	PRODUCT	ITEM NUMBER	PACKAGE TYPE & SIZE	COLOR	VISCOSITY (cP)†	TORQUE‡ in.-lbs. (break/prevail)	TEMP. RANGE	CURE SPEED (STEEL @ 25°C)	AGENCY APPROVALS										
MIL SPEC THREADLOCKERS	Low Strength	Easy removal, small screws under 1/4"	222MS™	22205	0.5 ml capsule	Purple	1,200 / 5,000 Thixotropic	53 / 30	-65°F to 300°F	Fixture – 10 min. Full – 24 hrs.	MIL-S-46163A for existing designs, ASTM D-5363**, NSF® P1, CFIA									
				22221 22231 22241	10 ml bottle 50 ml bottle 250 ml bottle															
	Medium Strength	Removable grade, 1/4" up to 3/4" bolts	242°	24205	0.5 ml capsule	Blue	1,200 / 5,000 Thixotropic	110 / 43	-65°F to 300°F	Fixture – 5 min. Full – 24 hrs.	MIL-S-46163A for existing designs, ASTM D-5363**, NSF®/ANSI 61, NSF® P1, ABS, CFIA									
				24221 24231 24241 24243	10 ml bottle 50 ml bottle 250 ml bottle 1 liter bottle															
				High Strength	High strength locking, up to 3/4" bolts							262™	26205	0.5 ml capsule	Red	1,800 / 5,000 Thixotropic	189 / 275	-65°F to 300°F	Fixture – 10 min. Full – 24 hrs.	MIL-S-46163A for existing designs, ASTM D-5363**, NSF® P1, ABS, CFIA
													26221 26231 26241 26243	10 ml tube 50 ml bottle 250 ml bottle 1 liter bottle						
High Strength	High strength for fasteners up to 1" diameter	271™	27105	0.5 ml capsule	Red	500	250 / 275	-65°F to 300°F	Fixture – 10 min. Full – 24 hrs.	MIL-S-46163A for existing designs, ASTM D-5363**, UL Classified for U.S., CFIA										
			27121 27131 27141 27143	10 ml bottle 50 ml bottle 250 ml bottle 1 liter bottle																
Wicking Grade	Low Strength Wicking grade for pre-assembled fasteners under 1/4"	220™	37388 39186 22041	10 ml bottle 50 ml bottle 250 ml bottle	Blue	20	85 / 170	-65°F to 300°F	Fixture – 6 min. Full – 24 hrs.	MIL-S-46163A for existing designs, ASTM D-5363**, CFIA										
			Medium/High Strength, Wicking grade for pre-assembled parts	290™ 							29005 29021 29031 29041 29043	0.5 ml capsule 10 ml bottle 50 ml bottle 250 ml bottle 1 liter bottle								

ITEMS IN RED = Source's PICK or NEW

** For new designs.
† Brookfield RVT spindle 3.20 RPM/25 RPM.

 = Indicates Worldwide Availability

PLEASE NOTE: A complete line of surface primers is available. Refer to the Surface Preparation section.

Your Source for
THREAD SEALING



[Table of Contents]

THREAD SEALING	149
THREAD SEALANTS	151
THREADLOCKERS & THREAD SEALANTS EQUIPMENT	155

THREAD SEALING

When choosing a thread sealant, there are several factors that need to be considered. The single most important question is substrate. Are you dealing with plastic threads, metal threads or a combination of both? Plastic threads usually require a different sealant than metal threads. In some instances, the environment becomes a factor. If the application requires the sealant to be in contact with harsh chemicals, then a chemically resistant sealant should be chosen. In other cases, the type of thread is important. For example, if the fitting to be sealed has large coarse threads, then a sealant with more gap fill should be chosen. Similarly, a low viscosity sealant would be better suited for fine threads. Therefore, when choosing a sealant, it is important to consider all of the factors. The following chart will help guide you through your choices.

Loctite® Adhesives and Sealants Product Specialists are available to assist you with new product designs, or to help you re-engineer an existing application for improved performance and cost savings. They can also set up testing of your parts at the Henkel Customer Engineering Center. For application assistance, call **1-800-LOCTITE (562-8483)**; *within Canada, call 1-800-263-5043*; or contact us through the web at www.henkelna.com/loctite.

STRAIGHT FROM *The Source*

FINDING THE RIGHT THREAD SEALANT FOR THE APPLICATION

What are the benefits of using thread sealants?

Thread sealants provide tight seals between joints, can withstand immense pressures, allow for easier assembly and disassembly, prevent corrosion, and prevent parts from “welding” to one another.

Which sealants have potable water approvals?

The following Loctite® thread sealants all have a NSF® 61 potable water approval rating: Loctite® QuickStix® 561™ PST®, 564™, 565™ PST® and 567™ PST®.

What is galling?

Galling occurs when metals weld together due to lack of lubrication or ineffective lubrication during assembly. Without proper lubrication, mating surfaces wear against each other and result in “welding” or seizure. Sealants containing PTFE increase lubricity, reduce galling, and enable easier assembly and disassembly.

Are there any thread sealants available that are compatible with systems in oxygen rich environments?

Loctite® Thread Sealant for Oxygen Compatible Systems and Loctite® Thread Seal Tape with PTFE are compatible with systems in oxygen rich environments.

Why is the “squeeze-out” material around the joint not cured?

In order for anaerobic material to cure, there have to be two mating metal surfaces. Any excess material that squeezes from the assembly can simply be wiped away.

Why use a solvent-based sealant on plastic fittings?

Anaerobic sealants work when they harden in the absence of air and the presence of a metal surface. On the other hand, solvent-based sealants harden when the solvent evaporates. In the case of plastic fittings, you must rely on a solvent-based sealant since there are no metal surfaces to cure the adhesive. Similarly, in those cases when joining metal to plastic fittings, solvent-based sealants are recommended. Because only half of the substrate is metal, anaerobic sealants may produce inconsistent cure.

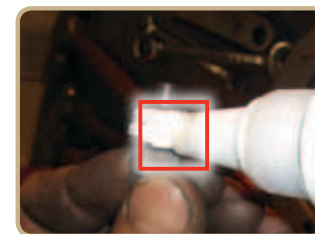
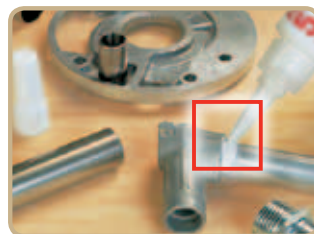
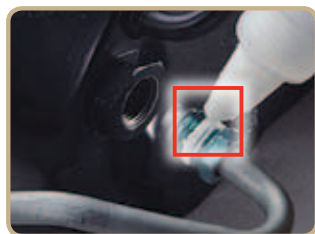

Your Source THREAD SEALANTS SELECTOR GUIDE

WHAT TYPE OF THREADS DO YOU HAVE?

Plastic-to-Plastic and Plastic-to-Metal	Metal-to-Metal		
SOLVENT-BASED	GENERAL-PURPOSE	PNEUMATIC/HYDRAULIC	LOW STRENGTH
Loctite® Thread Sealant with PTFE Item # 30561 1 pint brush-top can	Loctite® 564™ Thread Sealant Item # 28754 50 ml tube 28755 250 ml tube 34759 350 ml brush-top can	Loctite® 542™ Thread Sealant Item # 21453 50 ml bottle	Loctite® 572™ Thread Sealant Item # 21454 50 ml tube
Loctite® No More Leaks™ Plastic Pipe Sealant Item # 80726 1 pint brush-top can	Loctite® 565™ PST® Thread Sealant Item # 56507 6 ml tube 56531 50 ml tube 56541 250 ml tube 56571 300 ml cartridge 56543 1 liter bottle 56566 10 liter bottle	Loctite® 545™ Thread Sealant Item # 54505 0.5 ml capsule 32429 10 ml bottle 54531 50 ml bottle 54541 250 ml bottle	CHEMICAL RESISTANCE
Loctite® Pipe Joint Compound Item # 30557 1 pint brush-top can	Loctite® 577™ Thread Sealant Item # 21456 50 ml tube 21457 250 ml tube	Loctite® 569™ Thread Sealant Item # 56931 50 ml bottle 56941 250 ml bottle	Loctite® 571™ Thread Sealant Item # 57141 250 ml bottle
Loctite® H.V.A.C. Blue Pipe Joint Compound Item # 82481 1 pint brush-top can	Loctite® 579™ Thread Sealant Item # 57941 250 ml tube	Loctite® 5452™ Fast Cure Hydraulic/Pneumatic Sealant Item # 1265769 50 ml tube 1265770 250 ml tube	Loctite® 554™ Thread Sealant Item # 25882 10 ml bottle 55441 250 ml bottle
NON-CURING	LOW HALOGEN	HIGH TEMPERATURE	SEMISOLID
Loctite® Thread Seal Tape with PTFE Item # 39904 1/2" x 520" x 0.003"	Loctite® Head Bolt & Water Jacket Sealant Item # 1158514 50 ml tube	Loctite® 567™ PST® Thread Sealant 400°F (204°C) Item # 56707 6 ml tube 56747 50 ml tube 56765 250 ml tube 33241 350 ml brush-top can 56790 1 liter bottle	Loctite® 561™ QuickStix® PST® Pipe Sealant Item # 37127 19 g stick
	Loctite® 580™ PST® Thread Sealant Item # 58031 50 ml tube	Loctite® 592™ PST® Thread Sealant 400°F (204°C) Item # 59214 6 ml tube 59231 50 ml tube 59241 250 ml tube 59243 1 liter bottle	Loctite® 5671™ QuickStix® PST® Pipe Sealant Item # 1276167 19 g stick
	Loctite® 5802™ High Purity Thread Sealant Item # 1313319 50 ml tube	Loctite® 5770™ Thread Sealant 530°F (277°C) Item # 1138284 50 ml tube 1138281 250 ml bottle	OXYGEN COMPATIBLE
	Loctite® 5772™ Thread Sealant Item # 25524 50 ml bottle		Loctite® Thread Sealant for Oxygen Compatible Systems Item # 1265761 50 ml tube

Your Source for **THREAD SEALING**
THREAD SEALANTS

- Prevents leaks
- Single component – quick and easy to apply
- Can be used on any size pipe fitting and seals to the burst strength of most piping systems
- Prevents corrosion and galling in threads
- Seals and secures metal pipes and fittings, filling the space between threaded metal parts and hardening to prevent leakage
- Designed for high and low pressure applications

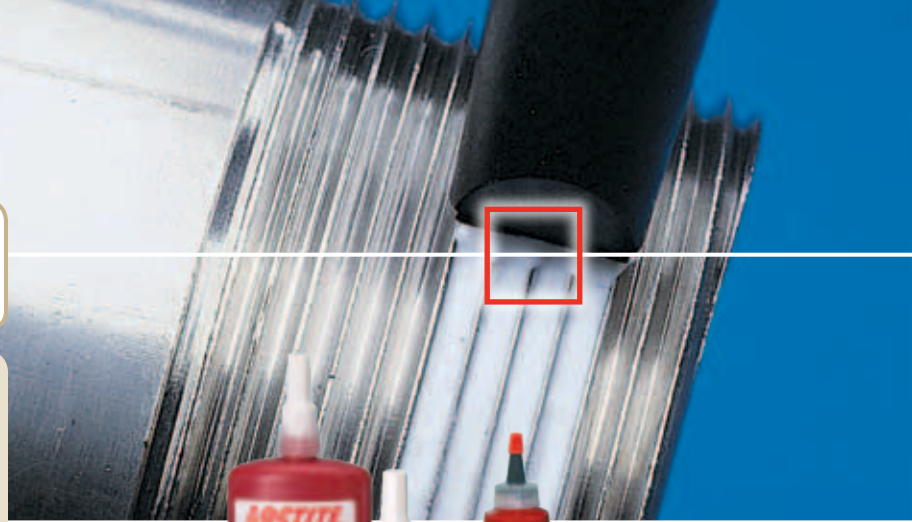

[General-Purpose]

Loctite® 564™ Thread Sealant

GENERAL-PURPOSE

Cures rapidly to provide immediate low pressure sealing. Its lower strength allows easy disassembly, and is recommended even on larger (>2 in. [50 mm]) diameter pipes. Protects mated threaded areas from rust and corrosion.

Item #	28754	50 ml tube
	28755	250 ml tube
	34759	350 ml brush-top can

Source's PICK
Loctite® 565™ PST® Thread Sealant

CONTROLLED STRENGTH

Formulated specifically for metal tapered pipe thread fittings, this product cures rapidly to provide immediate low pressure sealing. Controlled lubricity prevents galling and protects from rust and corrosion. Can be used on fittings up to 2 in. (50 mm) in diameter.

Item #	56507	6 ml tube
	56531	50 ml tube
	56541	250 ml tube
	56571	300 ml cartridge
	56543	1 liter bottle
	56566	10 liter bottle

Loctite® 577™ Thread Sealant

COARSE THREADS

Medium strength, general-purpose sealant for use on coarse-threaded components.

Item #	21456	50 ml tube
	21457	250 ml tube

Loctite® Head Bolt & Water Jacket Sealant

Single-component anaerobic hybrid that lubricates fasteners during assembly, seals gaps between threads, eliminates corrosion, locks and eases removal of fasteners that are through-holes into water jackets.

Item #	1158514	50 ml tube
--------	---------	------------

Loctite® 579™ Thread Sealant

INSTANT SEAL

A general-purpose pipe sealant that cures into a resistant plastic. Excellent solvent resistance. Withstands temperatures to 300°F (150°C). Sealing is effective on threaded joints up to 2 in. in diameter.

Item #	57941	250 ml tube
--------	-------	-------------

[High Temperature]

Source's PICK
Loctite® 567™ PST® Thread Sealant

HIGH TEMPERATURE

This product has excellent solvent resistance, allows easy assembly, prevents galling and can withstand temperatures up to 400°F (204°C). Excellent for high pressure applications: locks and seals tapered metal, pipe threads and fittings. Ideal for stainless steel, aluminum, galvanized metal and other inert metals. Disassembles with hand tools.

Item #	56707	6 ml tube
	56747	50 ml tube
	56765	250 ml tube
	33241	350 ml brush-top can
	56790	1 liter bottle

Loctite® 5770™ Thread Sealant

HIGH TEMPERATURE

Designed to seal threaded pipe fittings in applications requiring continuous heat resistance up to 530°F (277°C). Ideal for applications in pressurized steam lines and boiler rooms.

Item #	1138284	50 ml tube
	1138281	250 ml bottle

Loctite® 592™ PST® Thread Sealant

SLOW CURE

Locks and seals threaded fittings. Parts may be repositioned up to 24 hours after application.

Item #	59214	6 ml tube
	59231	50 ml tube
	59241	250 ml tube
	59243	1 liter bottle

[Low Odor]

Loctite® 5451™ Thread Sealant

LOW ODOR

Low odor formula suited for applications in sensitive areas or confined spaces.

Item #	1131756	50 ml tube
--------	---------	------------

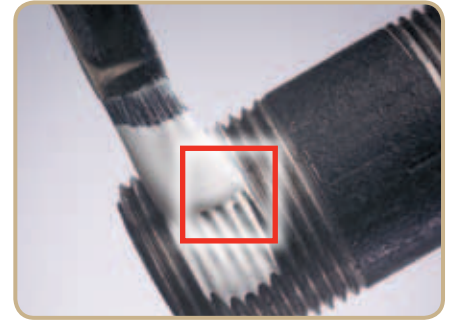

[Industries]

- Manufacturing
- Maintenance and Repair

[Hydraulic Sealant]

Loctite® 542™ Thread Sealant

FINE THREADS

A liquid sealant recommended for sealing the fine threads of hydraulic and pneumatic connectors.

Item # 21453 50 ml bottle

Loctite® 5772™ Thread Sealant

LOW SULFUR

A medium strength thread sealant with fast curing properties. Specially developed for use on sensitive metals, like titanium, used in the nuclear industry. Parts can be separated using hand tools.

Item # 25524 50 ml bottle

Loctite® 571™ Thread Sealant

CHEMICAL RESISTANCE

Medium strength thread sealant designed for locking and sealing against corrosive products. Shows excellent strength after long exposures to many chemicals.

Item # 57141 250 ml bottle

Source's PICK

Loctite® 545™ Thread Sealant

HYDRAULIC/PNEUMATIC FITTINGS

Contains no fillers or particles that could contaminate system fluids, foul valves, or clog fine filters and screens. Suitable for fittings up to 2 in. (50 mm) in diameter. Excellent solvent resistance.

Item # 54505 0.5 ml capsule
32429 10 ml bottle
54531 50 ml bottle
54541 250 ml bottle

Loctite® 5452™ Fast Cure Thread Sealant

FAST CURE HYDRAULIC/PNEUMATIC FITTINGS

Contains no fillers or particles that could contaminate system fluids, foul valves, or clog fine filters and screens.

Item # 1265769 50 ml tube
1265770 250 ml tube

[Low Halogen]

Loctite® 580™ PST® Thread Sealant

LOW SULFUR

For threaded fittings in fossil fuel, solar and hydro plant piping systems.

Item # 58031 50 ml tube

Loctite® 5802™ Thread Sealant

HIGH PURITY

A high purity thread sealant formulated to meet the green limit requirements of the nuclear industry. A high viscosity, medium strength thread sealant low in impurities, such as halogens, sulfur and low melting point metals.

Item # 1313319 50 ml tube

[Low Strength]

Loctite® 572™ Thread Sealant

LOW STRENGTH

Low strength sealant with moderate fixture speed for use on coarse threads.

Item # 21454 50 ml tube

[Chemical Resistance]

Loctite® 554™ Thread Sealant

REFRIGERANT SEALANT

Excellent solvent resistance on threaded fittings and pipes up to 3 in. (76.2 mm) in diameter. Recommended for refrigeration systems and service with aggressive chemicals.

Item # 25882 10 ml bottle
55441 250 ml bottle

[Semisolid Stick]

Loctite® QuickStix® 561™ PST® Pipe Sealant

New, patented, semisolid stick formula offers added convenience and portability. Like Loctite® 565™ PST®, this product has immediate low pressure sealing, eases disassembly and will not contaminate or clog lines. The semisolid formula also means it won't spill or leak, making it great for overhead applications or carrying in a pocket or toolbox.

Item # 37127 19 g stick

Loctite® QuickStix® 5671™ PST® Pipe Sealant

New, patented, semisolid stick formula offers added convenience and portability. Similar application characteristics of Loctite® QuickStix® 561™ and is ideal for stainless steel, aluminum, galvanized metal and other inert metals.

Item # 1276167 19 g stick

Your Source for **THREAD SEALING**
THREAD SEALANTS

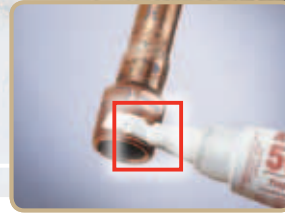

[Solvent-Based]

Loctite® Thread Sealant with PTFE

A general-purpose sealant with the added lubricity of PTFE for metal pipes. Won't shred like tape and allows easy disassembly. Resists common shop fluids.

Item # 30561 1 pint brush-top can

Loctite® Pipe Joint Compound

Economical, general-purpose pipe thread sealant that will not shred like tape and allows easy disassembly. Resists common shop fluids.

Item # 30557 1 pint brush-top can

Loctite® No More Leaks™ Plastic Pipe Sealant

Seals plastic pipes and allows easy disassembly. Specially formulated without the added lubricity of PTFE to avoid typical cracks when plastic joints are overtightened.

Item # 80726 1 pint brush-top can

Loctite® H.V.A.C. Blue Pipe Joint Compound

Tough, pliable sealant specially formulated for heating, air conditioning, and refrigeration applications. Sets up quickly for immediate assembly and keeps joints tight in areas of high vibration and thermal cycling. Seals oils, refrigerants, butane, propane, natural gas and more. Easy cleanup.

Item # 82481 1 pint brush-top can

[Non-Curing]

Loctite® Thread Seal Tape with PTFE

Tape (1/2" x 520") with plastic spool and shell. Can be used in applications with temperatures up to 500°F. Oxygen service compatible.

Item # 39904 1/2" x 520" x 0.003"

Loctite® Thread Sealant for Oxygen Compatible Systems

A white paste for sealing threads in systems carrying oxygen. For use up to 30 bar (435 psi) at 140°F (60°C).

Item # 1265761 50 ml tube



[Loctite® Liquid Thread Sealants Properties Chart]

	LOCTITE® PRODUCT	ITEM NUMBER	PACKAGE TYPE & SIZE	TYPICAL USE	COLOR & APPEARANCE	VISCOSITY (cP)	TEMPERATURE RANGE	PRESSURE RESISTANCE (psi)	RECOMMENDED PRIMER	AGENCY APPROVALS
GENERAL-PURPOSE	564™	28754 28755 34759	50 ml tube 250 ml tube 350 ml brush-top can	General-purpose, low strength for large diameter pipe	White	90,500	-65°F to 300°F	10,000	7088™, N™ or T™	NSF®/ANSI 61, CFIA
	565™ PST®	56507 56531 56541 56571 56543 56566	6 ml tube 50 ml tube 250 ml tube 300 ml cartridge 1 liter bottle 10 liter bottle	Controlled strength	White	300,000	-65°F to 300°F	10,000	7088™, N™ or T™	CSA International, UL Classified for U.S., NSF®/ANSI 61, CFIA, ULC Classified for Canada
	577™	21456 21457	50 ml tube 250 ml tube	Medium strength, coarse threads	Yellow	24,000/80,000 Thixotropic	-65°F to 300°F	10,000	7088™, N™ or T™	N/A
	HEAD BOLT & WATER JACKET	1158514	50 ml tube	Single component anaerobic	Black	Paste	-65°F to 300°F	10,000	7088™, N™ or T™	N/A
	579™	57941	250 ml tube	Low strength, instant seal	Silver/Brown	20,000	-65°F to 300°F	10,000	7088™, N™ or T™	N/A
HIGH TEMPERATURE	567™ PST®	56707 56747 56765 33241 56790	6 ml tube 50 ml tube 250 ml tube 350 ml brush-top can 1 liter bottle	For stainless steel and all other metal fittings	White	540,000	-65°F to 400°F	10,000	7088™, N™ or T™	UL Classified for U.S., ABS, CFIA, NSF®/ANSI 61, ULC Classified for Canada
	5770™	1138284 1138281	50 ml tube 250 ml tube	High temperature	Off-White Paste	Paste	-65°F to 530°F	N/A	7088™, N™ or T™	N/A
	592™ PST®	59214 59231 59241 59243	6 ml tube 50 ml tube 250 ml tube 1 liter bottle	Medium strength	White	350,000	-65°F to 400°F	10,000	NF™	CFIA
LOW ODOR	5451™	1131756	50 ml tube	Pneumatic/hydraulic sealant, no fillers	Purple	8,000/40,000	-65°F to 300°F	N/A	7088™, N™ or T™	N/A

ITEMS IN RED = Source's PICK or NEW

= Indicates Worldwide Availability

[Loctite® Liquid Thread Sealants Properties Chart]

	LOCTITE® PRODUCT	ITEM NUMBER	PACKAGE TYPE & SIZE	TYPICAL USE	COLOR AND APPEARANCE	VISCOSITY (cP)	TEMPERATURE RANGE	PRESSURE RESISTANCE (psi)	RECOMMENDED PRIMER	AGENCY APPROVALS
HYDRAULIC & PNEUMATIC	542™	 21453	50 ml bottle	Fine threads	Brown	525/1,850 Thixotropic	-65°F to 300°F	10,000	7088™, N™ or T™	N/A
	545™	 54505 32429 54531 54541	0.5 ml capsule 10 ml bottle 50 ml bottle 250 ml bottle	Pneumatic hydraulic sealant, no fillers	Purple	14,000	-65°F to 300°F	10,000	7088™, N™ or T™	ABS, CFIA
	5452™ FAST CURE	1265769 1265770	50 ml tube 250 ml tube	Pneumatic hydraulic sealant, no fillers	Purple	29,000/200,000 thixotropic	-65°F to 300°F	10,000	7088™, N™ or T™	N/A
LOW HALOGEN	569™	56931 56941	50 ml bottle 250 ml bottle	Original hydraulic sealant	Brown	400	-65°F to 300°F	10,000	7088™, N™ or T™	CFIA
	580™ PST®	58031	50 ml tube	Low halogen, low sulfur, PTFE-free	White	600,000	-65°F to 300°F	10,000	N/A	N/A
	5772™	25524	50 ml bottle	Low halogen, low sulfur, medium strength, fast cure	Yellow	7,500	-65°F to 300°F	10,000	N/A	N/A
LOW STRENGTH	5802™	1313319	50 ml tube	Low halogen, high purity, medium strength, high viscosity	Off-White	Paste	-65°F to 300°F	10,000	N/A	N/A
	572™	 21454	50 ml tube	Coarse threads	White	17,000/50,000 Thixotropic	-65°F to 300°F	10,000	7088™, N™ or T™	N/A
CHEMICAL RESISTANCE	554™	25882 55441	10 ml bottle 250 ml bottle	Refrigerant sealant, high strength	Red	2,500	-65°F to 300°F	10,000	7088™, N™ or T™	CFIA
	571™	57141	250 ml bottle	High strength, excellent solvent resistance	Brown	2,000	-65°F to 300°F	10,000	7088™, N™ or T™	MIL-S-22473E for existing designs, ASTM D-5363 for new designs
SEMISOLID STICK	QUICKSTIX® 561™ PST®	37127	19 g stick	General-purpose, portable, overhead	White Paste	Semisolid	-65°F to 300°F	10,000	7088™, N™ or T™	UL Classified for U.S., ULC Classified for Canada, CSA International, CFIA, NSF®/ANSI 61
	QUICKSTIX® 5671™ PST®	1276167	19 g stick	Stainless steel and other metal fittings	Off-White Paste	Semisolid	-65°F to 300°F	10,000	7088™, N™ or T™	N/A
SOLVENT-BASED	THREAD SEALANT WITH PTFE	30561	1 pint brush can	General-purpose, metal pipes, added lubricity	White Paste	50,000 to 60,000	-65°F to 300°F	5,000	N/A	CFIA
	PIPE JOINT COMPOUND	30557	1 pint brush can	General-purpose, non-shredding, chemical resistant	Black Paste	35,000 to 45,000	-65°F to 400°F	5,000	N/A	N/A
	NO MORE LEAKS™	80726	1 pint brush can	Plastic pipes, easy disassembly	White Paste	90,000 to 110,000	-65°F to 300°F	5,000	N/A	CFIA
NON-CURING	H.V.A.C. BLUE PIPE JOINT COMPOUND	82481	1 pint brush can	Heating, air conditioning, refrigeration	Blue Paste	20,000 to 30,000	-65°F to 400°F	5,000	N/A	CFIA
	THREAD SEAL TAPE WITH PTFE	39904	1/2" x 520" x 0.003"	General-purpose, oxygen service compatible	White Tape	N/A	Up to 500°F	Pressure Rating for Pipe	N/A	Conforms to MIL-T-27730
	THREAD SEALANT FOR OXYGEN COMPATIBLE SYSTEMS	1265761	50 ml tube	Oxygen carrying systems	White Paste	Paste	60°C	30 bar 435 psi	N/A	BAM

ITEMS IN RED = Source's PICK or NEW  = Indicates Worldwide Availability

Your Source for **THREADLOCKING & THREAD SEALING**
THREADLOCKERS & THREAD SEALANTS EQUIPMENT

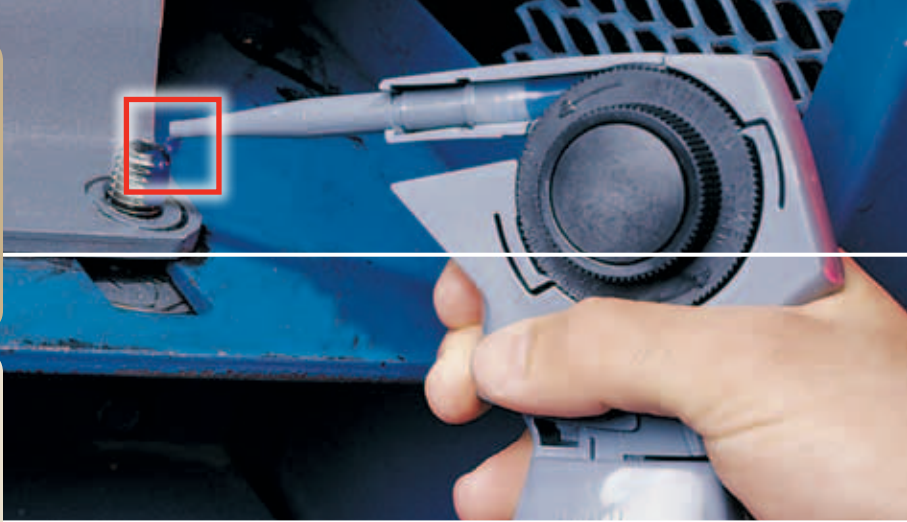

YOUR EQUIPMENT Source
 For more details, see the **Loctite® Equipment Sourcebook, LT-3669**, or visit us on the web for additional information, diagrams, products and our full line of equipment at www.equipment.loctite.com.



LOCTITE® PRODUCT		ITEM NUMBER	USED TO DISPENSE	PACKAGE TYPES & SIZES	VISCOSITY RANGE	PACKAGE TYPES & SIZES	CONSUMABLES – DISPENSE ACCESSORIES	
HANDHELD APPLICATORS	BOTTLE DISPENSING							
		SOFT SQUEEZE BOTTLES	98345	All Fluids	2 fl. oz. packages	Low to Medium	Manual	N/A
			98346	All Fluids	4 fl. oz. packages			
			98347	All Fluids	8 fl. oz. packages			
		50 ML AND 250 ML HAND PUMPS	98414 97001	Retaining Compounds, Threadlockers	50 ml bottle 250 ml bottle	Low to Medium	Manual	Dispense Tips and Accessories – Pages 184-188
TUBE DISPENSING								
	50 ML-F TUBE SQUEEZE DISPENSER	1083845	Any 50 ml tube	50 ml tubes	Low to High	Manual	N/A	





LOCTITE® PRODUCT		ITEM NUMBER	PRESSURE REGULATION	USED TO DISPENSE	PACKAGE TYPES & SIZES	VISCOSITY RANGE	LOW LEVEL SENSING	CONSUMABLES – DISPENSE ACCESSORIES	
CONTROLLERS & RESERVOIRS	INTEGRATED RESERVOIR CONTROLLERS								
		INTEGRATED SEMI-AUTOMATIC DISPENSER	1390322	0 to 15 psi	Gel Adhesives, Instant Adhesives, Light Cure/Acrylics, Retaining Compounds, Threadlockers	250 ml bottle 1 lb. bottle 1 liter bottle 2 kg bottle 200 g squeeze tube	Low to Medium	Yes	Dispense Tips and Accessories – Pages 182-186
			1390321	0 to 100 psi				Medium to High	
	RESERVOIRS								
		BOND-A-MATIC® 3000 RESERVOIR	982720	0 to 15 psi	Gel Adhesives, Instant Adhesives, Light Cure/Acrylics, Retaining Compounds, Threadlockers	250 ml bottle 1 lb. bottle 1 liter bottle 2 kg bottle 200 g squeeze tube	Low to Medium	Yes	Dispense Tips and Accessories – Pages 182-186
			982726					No	
			982723	0 to 100 psi				Medium to High	
982727			No						
	SHOT MISER™ RESERVOIR	98090	0 to 100 psi	Instant Adhesives, Light Cure/Acrylics, Retaining Compounds, Threadlockers	250 ml bottle 1 lb. bottle 200 g squeeze tube	Low to High	No		
	4 LITER GRAVITY FEED RESERVOIR	982880	N/A	Retaining Compounds, Threadlockers	Direct Fill	Low to Medium	Yes		







LOCTITE® PRODUCT		ITEM NUMBER	DISPENSE PATTERNS	USED TO DISPENSE	PACKAGE TYPES & SIZES	VISCOSITY RANGE	VACUUM SUCK-BACK	CONSUMABLES – DISPENSE ACCESSORIES
DISPENSE SYSTEMS	PINCH TUBE APPLICATORS							
		DIAL-A-SEAL® APPLICATORS	998400	N/A	Pipe Sealants	50 ml tube 250 ml tube 1 liter bottle	Medium to High	N/A

ITEMS IN RED = Source's PICK or NEW

For more Loctite® branded equipment, go to page 171. Can't find what you're looking for? Visit www.equipment.loctite.com.

LOCTITE® PRODUCT		ITEM NUMBER	DISPENSE PATTERNS	USED TO DISPENSE	PACKAGE TYPES & SIZES	VISCOSITY RANGE	VACUUM SUCK-BACK	CONSUMABLES – DISPENSE ACCESSORIES	
VOLUMETRIC BOTTLE DISPENSING									
DISPENSE SYSTEMS		BENCHTOP PERISTALTIC DISPENSER	98548	Dot, Drop, Bead	Instant Adhesives, Light Cure/Acrylics, Retaining Compounds, Threadlockers	Any	0 to 5,000 cP	N/A	Dispense Tips and Accessories – Pages 182-186
	COMPLETE PRESSURE-TIME BOTTLE DISPENSE SYSTEM								
		BOND-A-MATIC® 3000 DISPENSER 0-15 psi	982719	Dot, Drop, Bead	Gel Adhesives, Instant Adhesives, Light Cure/Acrylics, Retaining Compounds, Threadlockers	200 ml bottle 1 lb. bottle 1 liter bottle 2 kg bottle 200 g squeeze tube	Low Medium to High	N/A	Dispense Tips and Accessories – Pages 182-186
	BOND-A-MATIC® 3000 DISPENSER 0-100 psi	982722							
	SHOT MISER™ VALVE CONTROLLER	98079	Dot, Drop, Bead	Instant Adhesives, Light Cure/Acrylics, Retaining Compounds, Threadlockers	250 ml bottle 1 lb. bottle	Low to Medium	N/A		
	SHOT MISER™ DISPENSE VALVE	98085							
	SHOT MISER™ RESERVOIR	98090							

LOCTITE® PRODUCT		ITEM NUMBER	TYPE	VISCOSITY RANGE	DISPENSE PATTERNS	USED TO DISPENSE	STROKE ADJUSTMENT	ACTION	CONSUMABLES – DISPENSE ACCESSORIES	
GENERAL-PURPOSE APPLICATORS										
HANDHELD VALVES		LV HAND-HELD APPLICATOR	97130	Pneumatic	Low	Drop, Dot, Bead	Instant Adhesives, Retaining Compounds, Threadlockers	Yes	Foot	Dispense Tips and Accessories – Pages 182-186
	GENERAL-PURPOSE APPLICATORS									
		MANUAL HAND-HELD APPLICATOR	97111	Manual	Low to Medium	Drop, Dot, Bead	Light Cure/Acrylics, Retaining Compounds, Threadlockers	Yes	Finger	Dispense Tips and Accessories – Pages 182-186
		PNEUMATIC HAND-HELD APPLICATOR	97112	Pneumatic	Low to Medium	Drop, Dot, Bead	Light Cure/Acrylics, Retaining Compounds, Threadlockers	Yes	Foot	
	PNEUMATIC HAND-HELD APPLICATOR	97116	Pneumatic	Low to Medium	Drop, Dot, Bead	Light Cure/Acrylics, Retaining Compounds, Threadlockers	Yes	Finger		
GENERAL-PURPOSE APPLICATORS										
	VARI-DROP™ APPLICATORS	97131	Pinch Tube	Low to Medium	Drop, Dot, Bead	Instant Adhesives, Retaining Compounds, Threadlockers	Yes	Finger	Dispense Tips and Accessories – Pages 182-186	
		97132								

LOCTITE® PRODUCT		ITEM NUMBER	TYPE	VISCOSITY RANGE	DISPENSE PATTERNS	USED TO DISPENSE	STROKE ADJUSTMENT	SUCK-BACK	CONSUMABLES – DISPENSE ACCESSORIES
HIGH PRECISION VALVES									
	STATIONARY APPLICATOR VALVE	97113	High Precision	Low to Medium	Drop, Dot, Bead	Gel Instant Adhesives, Instant Adhesives, Retaining Compounds, Threadlockers	Yes	Yes	Dispense Tips and Accessories – Pages 182-186
HIGH PERFORMANCE DIAPHRAGM VALVES									
	LIGHT CURE DISPENSE VALVE	98009	High Performance Diaphragm	Low to Medium	Drop, Dot, Bead	Instant Adhesives, Retaining Compounds, Threadlockers	Yes	No	Dispense Tips and Accessories – Pages 182-186
	CYANOACRYLATE DISPENSE VALVE	98013	High Performance Diaphragm	Low to Medium	Drop, Dot, Bead, Microdot	Instant Adhesives, Retaining Compounds, Threadlockers	Yes	No	
GENERAL DUTY DIAPHRAGM VALVES									
	DIAPHRAGM VALVE	97135	General Duty Diaphragm	0 to 2,500 cP	Drop, Dot, Bead	Light Cure/Acrylics, Instant Adhesives, Retaining Compounds, Threadlockers	No	No	Dispense Tips and Accessories – Pages 182-186
				97136					
HIGH VISCOSITY FLUID AND PASTE VALVES									
	POPPET VALVE	986300	High Viscosity Fluid and Paste	Medium to High	Drop, Bead	Anaerobic Gasketing, Retaining Compounds, Threadlockers	Yes	Yes	Dispense Tips and Accessories – Pages 182-186
PINCH TUBE VALVE									
	SHOT MISER™ DISPENSE VALVE	98085	Pinch Tube Valve	Low to Medium	Drop, Dot, Bead	Instant Adhesives, Retaining Compounds, Threadlockers	No	No	Dispense Tips and Accessories – Pages 182-186
POSITIVE DISPLACEMENT PUMP									
	POSITIVE DISPLACEMENT PUMP	983330	Positive Displacement Valve	Low to Medium	Drop	Retaining Compounds, Threadlockers, Any single-component, non-moisture-curing, low-to-medium viscosity fluid (<100,000 cP)	Yes	No	Dispense Tips and Accessories – Pages 182-186

Your Source for
TOOLBOXES & SPECIALTY KITS



[Specialty Repair]

Loctite® Form-A-Thread® Stripped Thread Repair Kit

Permanently repairs stripped threads and fasteners in five minutes (up to SAE Grade 5 English and 8.8 metric). Allows up to 1,538 in. lbs. torque (on 1 in. bolt) and 300°F (149°C) Resists most shop fluids.

Item # 28654 12.9 ml kit

Loctite® O-Ring Making Kit

Makes replacement, high performance O-rings in less than a minute. This compact kit contains four 3-foot lengths of common diameters of Buna N (nitrile) cord, Loctite® 404™ Quick Set™ Instant Adhesive, O-ring fixture, blade, a waterproofing solution, and a cleanup solution. *Available in Metric and Standard. Cut and splice tool and standard size cord stock are available.*

Item # Standard – 00112 See Opposite Page for Contents in Kit
 Metric – 40488 See Opposite Page for Contents in Kit

Loctite® Adhesives and Sealants Product Specialists are available to assist you with new product designs, or to help you re-engineer an existing application for improved performance and cost savings. They can also set up testing of your parts at the Henkel Customer Engineering Center. For application assistance, call **1-800-LOCTITE (562-8483)**; *within Canada, call 1-800-263-5043*; or, contact us through the web at www.henkelna.com/loctite.

STRAIGHT FROM *The Source*

Loctite® Pipe Repair Kit

Urethane-impregnated fiberglass tape, activated by water, for reliable, temporary repairs of metal, plastic and composite pipes. Includes Loctite® Fixmaster® Metal Magic Steel™ epoxy stick, urethane-impregnated fiberglass tape and gloves. Cures in 30 minutes.

Item # 96321 2 in. x 6 ft. tape
 96322 4 in. x 12 ft. tape

[General Maintenance]

Loctite® Quick Service Toolkit

The “original” Loctite® kit containing eight of the most common Loctite® products.

Item # 00101 See Opposite Page for Contents in Kit

Loctite® Toolbox

Containing 16 of the latest and best Loctite® technologies to solve the most common mechanical failures, this kit has everything a professional needs to increase reliability at the base component level.

Item # 38956 See Opposite Page for Contents in Kit

Loctite® Insulating & Sealing Wrap

Non-sticky, self-fusing, multipurpose wrap. Insulates electrical, seals leaks, improves grip. Hundreds of uses: industrial, automotive and marine.

Item # 1212164 1 in. x 10 ft. Red
 1496756 2 in. x 36 ft. Black

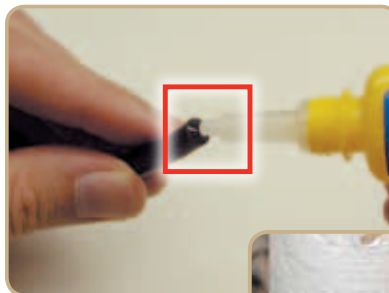

[Loctite® Toolboxes & Specialty Kits Ordering Chart]

	LOCTITE® PRODUCT	ITEM NUMBER	KIT CONTENTS & CONTAINER	MAXIMUM TEMPERATURE RESISTANCE	COLOR	AGENCY APPROVALS
SPECIALTY REPAIR	FORM-A-THREAD® STRIPPED THREAD REPAIR KIT	28654	12.9 ml kit	300°F (149°C)	Grey (Mixed)	CFIA
	LOCTITE® O-RING MAKING KIT	Standard: 00112 Metric: 40488	1 oz. waterproofing solution, item number 74126 1 oz. cleanup solvent, item number 75326 1/3 oz. 404™ Quick Set™ instant adhesive, item number 46551 Fixture and cutting blade [STANDARD] Cord: 3/32 in., 1/8 in., 3/16 in., 1/4 in. 98613 Precision O-Ring Cut & Splice Tool 8900591 O-Ring Stock, Buna N, 1/4 in. x 3 ft. 8900589 O-Ring Stock, Buna N, 1/8 in. x 3 ft. 8900588 O-Ring Stock, Buna N, 3/32 in. x 3 ft. 8900590 O-Ring Stock, Buna N, 3/16 in. x 3 ft. [METRIC] Cord: 1.6 mm, 2.4 mm, 3.0 mm, 5.7 mm, 8.4 mm	N/A	Clear	CFIA
	PIPE REPAIR KIT	96321 96322	2 in. x 6 ft. tape 4 in. x 12 ft. tape	250°F (121°C)	Yellow	CFIA
GENERAL MAINTENANCE	LOCTITE® QUICK SERVICE TOOLKIT	00101	243™ Threadlocker, Medium Strength, 10 ml 263™ Threadlocker, Primerless High Strength, 10 ml 7088™ QuickStix® Primer, 17 g 454™ Prism® Instant Adhesive Gel, 3 g 660™ Quick Metal® Retaining Compound, 6 ml 565™ PST® Thread Sealant, 50 ml 587™ Blue RTV Silicone Gasket Maker, 70 ml 518™ Gasket Eliminator® Flange Sealant, 50 ml	N/A	N/A	N/A
	LOCTITE® TOOLBOX	38956	220™ Threadlocker, Low Strength/Wicking, 10 ml 222™ Threadlocker, Low Strength/Small Screw, 10 ml 243™ Threadlocker, Medium Strength, 10 ml QuickStix® 248™ Threadlocker, Medium Strength, 9 g QuickStix® 268™ Threadlocker, High Strength, 9 g 263™ Threadlocker, Primerless High Strength, 10 ml 404™ Quick Set™ Instant Adhesive, 1/3 oz. 518™ Gasket Eliminator® Flange Sealant, 50 ml 545™ Thread Sealant, Hydraulic/Pneumatic, 10 ml QuickStix® 561™ PST® Pipe Sealant, 19 g 565™ PST® Thread Sealant, 50 ml 587™ Blue, High Performance RTV Silicone, 70 ml 641™ Retaining Compound, Low Strength, 10 ml 660™ Quick Metal® Retaining Compound, 50 ml QuickStix® C5-A® Copper-Based Anti-Seize, 20 g 7088™ QuickStix® Primer, 17 g QuickTite® Instant Adhesive Gel, 0.14 oz. net wt. bottle	N/A	N/A	N/A
	LOCTITE® INSULATING & SEALING WRAP	1212164 1496756	1 in. x 10 in. 2 in. x 36 in.	500°F (260°C)	Red Black	N/A

ITEMS IN RED = Source's PICK or NEW

Your Source for
MEDICAL APPLICATION SOLUTIONS

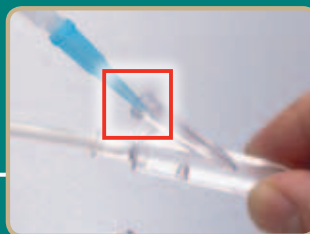

[Table of Contents]

MEDICAL APPLICATION SOLUTIONS	159
LIGHT CURE ACRYLIC ADHESIVES	161
CYANOACRYLATES, ACCELERATORS & PRIMERS	162
EPOXIES, SILICONES & URETHANES	165
MEDICAL CURING EQUIPMENT	167
MEDICAL DISPENSING EQUIPMENT	169

Loctite® adhesives have been specified by medical device manufacturers all over the world for over two decades. Our experience, products and engineering services are second to none, with the world's most diversified and comprehensive line of adhesives, dispensing equipment and curing systems available anywhere. We offer over 75 products for medical device assemblies requiring biocompatibility and hundreds of other products for applications not requiring toxicity testing.

LOCTITE® MEDICAL DEVICE ADHESIVES OFFER MANY BENEFITS, INCLUDING:

- Comprehensive ISO® 10993 biocompatibility testing
- Ability to bond dissimilar and difficult substrates
- Even stress distribution
- Excellent gap filling capability
- Rapid fixture and overall cure times
- Structural bonds
- Increased throughput

Loctite® Adhesives and Sealants Product Specialists are available to assist you with new product designs, or to help you re-engineer an existing application for improved performance and cost savings. They can also set up testing of your parts at the Henkel Customer Engineering Center. For application assistance, call **1-800-LOCTITE (562-8483)**; *within Canada, call 1-800-263-5043*; or contact us through the web at www.henkelna.com/loctite.

STRAIGHT FROM *The Source*

Our medical device adhesives cover almost every adhesive chemistry conceivable, providing you with a wide range of choices and assembly solutions. We know one product won't fit every design, and that's why we continue to create and add new products, new chemistries and even new technologies. No matter what the application, chances are we have the right adhesive for the job. Our products are available in viscosities ranging from water-thin liquids to thixotropic gels, and are compatible with common sterilization methods such as ethylene oxide, gamma radiation, electron beam, liquid sterilization, autoclave, and peroxide plasma.

GETTING STARTED – SELECTING A MEDICAL DEVICE ADHESIVE

The following chart has been designed to help you select a medical device adhesive. This chart is intended to serve as a general guideline to help you determine which adhesive categories are best suited for your application. The data presented represents typical properties for each adhesive category; however, individual product properties may differ. Individual product information can be found on the pages that follow to help you narrow your search.

HENKEL OFFERS THE MOST COMPREHENSIVE LINE OF LOCTITE® ADHESIVES AND SEALANTS AVAILABLE TO THE MEDICAL DEVICE INDUSTRY

These ISO® 10993-compliant products are designed specifically for the assembly of medical devices where toxicity testing and sterilization resistance are required.

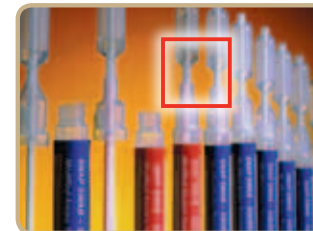
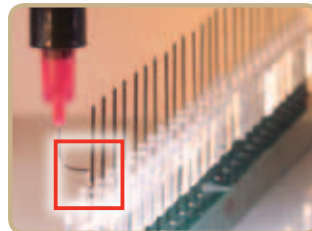
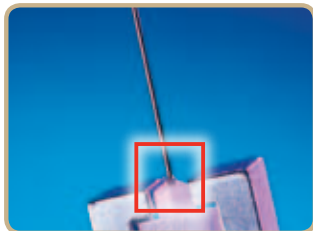

Your Source MEDICAL APPLICATION SOLUTIONS SELECTOR GUIDE

PERFORMANCE CONSIDERATIONS	ADHESIVE CATEGORY				
	CYANOACRYLATES	EPOXIES	LIGHT CURE ADHESIVES	SILICONES	URETHANES
BENEFITS	Wide range of bonding applications	Wide range of formulations	Rapid cure/adhesion to plastics	Excellent temperature resistance	Excellent toughness/flexibility
LIMITATIONS	Low solvent resistance	Mixing required	Light cure system required	Low cohesive strength	Sensitive to moisture
TEMPERATURE RESISTANCE					
TYPICAL FOR THE CATEGORY	-65°F to +180°F (-54°C to 82°C)	-65°F to +300°F (-54°C to 149°C)	-65°F to +300°F (-54°C to 149°C)	-65°F to +350°F (-54°C to 177°C)	-65°F to +250°F (-54°C to 121°C)
HIGHEST RATED PRODUCT	250°F (121°C)	300°F (149°C)	300°F (149°C)	350°F (177°C)	250°F (121°C)
ENVIRONMENTAL RESISTANCE					
POLAR SOLVENTS <small>(EX.: H₂O, ETHYLENE GLYCOL, ISOPROPYL ALCOHOL, ACETONE)</small>	Poor ¹	Very Good	Good	Good	Good
NON-POLAR SOLVENTS <small>(EX.: MOTOR OIL, TOLUENE, GASOLINE, ATF)</small>	Good	Excellent	Very Good	Poor to Fair	Good
ADHESION TO SUBSTRATES					
METALS	Very Good	Excellent	Good	Good	Good
PLASTICS²	Excellent	Fair	Excellent	Good	Very Good
GLASS	Poor	Excellent	Excellent	Good	Good
RUBBER	Very Good	Fair	Fair	Fair	Good
OVERLAPPING SHEAR STRENGTH	High	High	High	Low	Medium
PEEL STRENGTH	Low ³	Medium	Medium	Medium	Medium
TENSILE STRENGTH	High	High	High	Low	Medium
ELONGATION/FLEXIBILITY	Low	Low	Medium	Very High	High
HARDNESS	Rigid	Rigid	Semi-Rigid	Soft	Soft
PERFORMANCE CONSIDERATIONS	ADHESIVE CATEGORY				
	CYANOACRYLATES	EPOXIES	LIGHT CURE ADHESIVES	SILICONES	URETHANES
NUMBER OF COMPONENTS	1	1 and 2	1	1	2
CURE TEMPERATURES	Room Temperature	Heat or Room Temperature	UV/Visible	UV/Visible	Room Temperature
FIXTURE TIME					
AVERAGE	60 seconds	5 hours	30 seconds	10 minutes	5 hours
FASTEST	< 5 seconds	15 to 20 minutes	5 seconds	60 seconds	5 hours
FULL CURE TIME	24 hours	30 minutes to 24 hours	30 to 60 seconds	24 hours	24 hours
GAP FILL					
IDEAL (IN INCHES)	0.001 to 0.003	0.004 to 0.006	0.002 to 0.010	0.004 to 0.006	0.004 to 0.006
MAXIMUM (IN INCHES)	0.010	0.5	0.25	0.25	0.5
DISPENSING/MIXING EQUIPMENT REQUIRED	No	Yes (2 parts)	No	No	Yes
LIGHT CURE VERSIONS AVAILABLE?	Yes	No	Yes	Yes	No

¹ Cyanoacrylates have very good moisture resistance on plastics.

² Uncured liquid adhesives may cause stress cracking of certain thermoplastics, e.g., polycarbonate, acrylic and polysulfone. Special products and process techniques are available. Consult the Loctite® Design Guide to Bonding Plastics (LT-2197) or contact 1-800-LOCTITE (562-8483) for more information.

³ Exception: Toughened cyanoacrylates have high peel strength.

Your Source for **MEDICAL APPLICATION SOLUTIONS**
LIGHT CURE ACRYLIC ADHESIVES

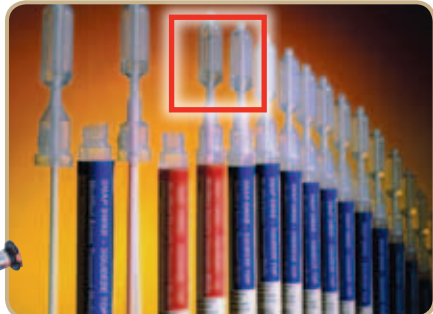
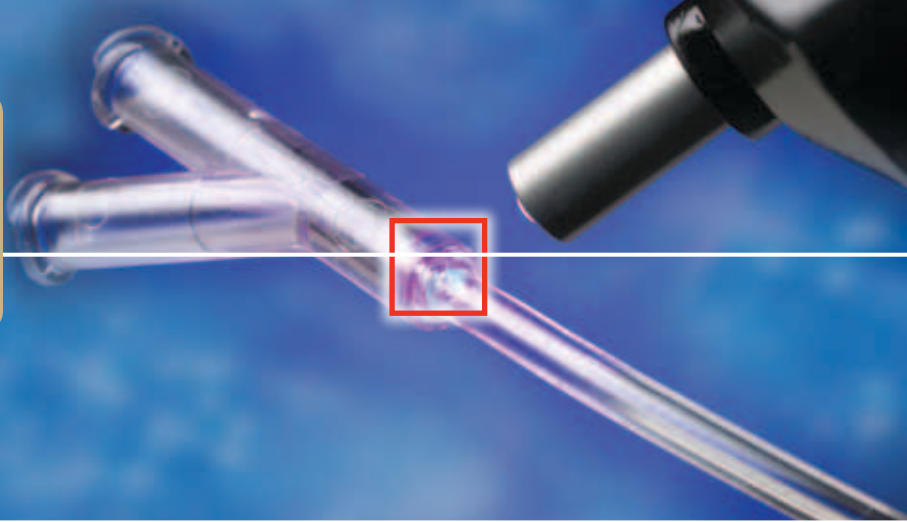

Sources **REVEALED**

[Visible with Fluorescence]

Source's PICK **Loctite® 3554™/3555™/3556™ Indigo® Visible Light Cure Adhesives**

Low, medium and high viscosity adhesives that cure in the visible spectrum offering properties and performance similar to most UV/visible adhesives. Visible light adhesives cure with unique systems that minimize venting or specialized safety equipment. Benefits include lower initial investment and reduced maintenance costs.

Item #	3554™	1072199	25 ml syringe
	3554™	1072198	1 liter bottle
	3555™	1072221	25 ml syringe
	3555™	1072200	1 liter bottle
	3556™	1072223	25 ml syringe
	3556™	1072222	1 liter bottle

[UV/Visible with Fluorescence]

Loctite® 3341™ Light Cure Adhesive
PLASTICIZED SUBSTRATES

A rapid cure, UV/visible, fluorescing adhesive that bonds highly plasticized PVC and other difficult-to-bond substrates.

Item #	23792	25 ml syringe
	23440	1 liter bottle

Source's PICK **Loctite® 3921™/3922™/3924™/3926™ Light Cure Adhesives**

PLASTIC/METAL

Fluorescing, UV/visible adhesives offering superior sterilization resistance. Ideal for bonding a wide variety of plastic and metal components where environmental resistance is required.

Item #	3921™	36484	25 ml syringe
	3921™	36485	1 liter bottle
	3922™	32083	25 ml syringe
	3922™	32047*	1 liter bottle
	3924™	36488	25 ml syringe
	3924™	36489	1 liter bottle
	3926™	36492	25 ml syringe
	3926™	36493	1 liter bottle

Source's PICK **Loctite® 3941™/3942™/3943™ Light Cure Adhesives**

HIGH PERFORMANCE/ VARIOUS SUBSTRATES

Fluorescing, UV / visible acrylic adhesives. Ideal for applications where high strength on a variety of substrates and rapid surface cure are required.

Item #	3941™	36437	25 ml syringe
	3941™	36476	1 liter bottle
	3942™	36483	25 ml syringe
	3942™	36481	1 liter bottle
	3943™	36480	25 ml syringe
	3943™	36478	1 liter bottle

Source's PICK **Loctite® 3971™/3972™ Light Cure Adhesives**

PLASTICIZED SUBSTRATES

Rapid curing, UV/visible, fluorescing adhesives that bond highly plasticized materials, including PVC and polyurethane.

Item #	3971™	36792	25 ml syringe
	3971™	36805	1 liter bottle
	3972™	36294	25 ml syringe
	3972™	36295	1 liter bottle

Loctite® 3974™ Light Cure Adhesive

HIGHLY FLEXIBLE

A highly resilient, extremely flexible, thermal-cycling resistant UV/visible adhesive that bonds plastic, metal and glass.

Item #	1135733	25 ml syringe
	1135732	1 liter bottle

Loctite® 3979™ Light Cure Adhesive

GEL, FLUORESCES RED

A rapid curing, UV/visible non-sag gel which fluoresces red.

Item #	1402562	25 ml syringe
	1402563	300 ml cartridge

* Made-to-order item.

[UV/Visible Without Fluorescence]

**Loctite® 3201™/3211™
Light Cure Adhesives**

POLYCARBONATE/THERMOPLASTICS

High viscosity, UV/visible adhesives that form very flexible joints with minimal stress cracking. Ideal for bonding polycarbonate and other thermoplastics.

Item #	3201™	19727	25 ml syringe
	3201™	19728	1 liter bottle
	3211™	19730	25 ml syringe
	3211™	19731*	1 liter bottle

**Loctite® 3301™/3311™/3321™
Light Cure Adhesives**

PLASTIC/METAL

Low viscosity, slightly flexible, UV/visible adhesives. Excellent for bonding thermoplastics and plasticized PVC.

Item #	3301™	19733	25 ml syringe
	3301™	19734	1 liter bottle
	3311™	19736	25 ml syringe
	3311™	19737	1 liter bottle
	3321™	19739	25 ml syringe
	3321™	19740	1 liter bottle

When **CONFIDENCE** IN CURE is Critical. **ASSURE CURE™**

Interested in an In-line System to Quantifiably **Confirm Completion of Cure?**

Contact Henkel at medical.adhesives@us.henkel.com.

[Loctite® Medical Device Acrylic Adhesives Properties Chart]

LOCTITE® PRODUCT		ITEM NUMBER	PACKAGE TYPE & SIZE	APPEARANCE/CLARITY/COLOR	CURE TYPE	KEY SUBSTRATES	VISCOSITY (cP) BROOKFIELD (25°C)	TEMPERATURE RANGE	ISO® 10993 COMPLIANT
ACRYLIC VISIBLE WITH FLUORESCENCE	3554™ INDIGO®	1072199 1072198	25 ml syringe 1 liter bottle	Clear/Light Yellow	Visible	Polycarbonate, thermoplastic, polyvinylchloride	300	-65°F to 300°F (-54°C to 149°C)	●
	3555™ INDIGO®	1072221 1072200	25 ml syringe 1 liter bottle	Clear /Light Yellow	Visible	Polycarbonate, thermoplastic, polyvinylchloride	1,000	-65°F to 300°F (-54°C to 149°C)	●
	3556™ INDIGO®	1072223 1072222	25 ml syringe 1 liter bottle	Clear /Light Yellow	Visible	Polycarbonate, thermoplastic, polyvinylchloride	5,000	-65°F to 300°F (-54°C to 149°C)	●
ACRYLIC UV/VISIBLE WITH FLUORESCENCE	3341™	23792 23440	25 ml syringe 1 liter bottle	Clear/Straw/Fluorescent	Ultraviolet, visible	Thermoplastics, polyvinylchloride	450	-65°F to 300°F (-54°C to 149°C)	●
	3921™	36484 36485	25 ml syringe 1 liter bottle	Transparent to Hazy/Fluorescent	Ultraviolet, visible	Glass, metal, thermoplastic, polycarbonate, polyvinylchloride	150	-65°F to 300°F (-54°C to 149°C)	●
	3922™	32083 32047*	25 ml syringe 1 liter bottle	Transparent to Hazy/Fluorescent	Ultraviolet, visible	Glass, metal, thermoplastic, polycarbonate, polyvinylchloride	300	-65°F to 300°F (-54°C to 149°C)	●
	3924™	36488 36489	25 ml syringe 1 liter bottle	Transparent to Hazy/Fluorescent	Ultraviolet, visible	Glass, metal, thermoplastic, polycarbonate, polyvinylchloride	1,100	-65°F to 300°F (-54°C to 149°C)	●
	3926™	36492 36493	25 ml syringe 1 liter bottle	Transparent to Hazy/Fluorescent	Ultraviolet, visible	Glass, metal, thermoplastic, polycarbonate, polyvinylchloride	4,500	-65°F to 300°F (-54°C to 149°C)	●
	3933™	32040*	1 liter bottle	Transparent to Hazy/Fluorescent	Ultraviolet, visible	Glass, metal, thermoplastic, polycarbonate	3,250	-65°F to 300°F (-54°C to 149°C)	●
	3936™	32304 32037*	25 ml syringe 1 liter bottle	Transparent to Hazy/Fluorescent	Ultraviolet, visible	Glass, metal, thermoplastic, polycarbonate	10,000	-65°F to 300°F (-54°C to 149°C)	●
	3941™	36437 36476	25 ml syringe 1 liter bottle	Transparent to Hazy/Fluorescent	Ultraviolet, visible	Glass, metal, thermoplastic, thermoset plastic	480	-65°F to 300°F (-54°C to 149°C)	●
	3942™	36483 36481	25 ml syringe 1 liter bottle	Transparent to Hazy/Fluorescent	Ultraviolet, visible	Glass, metal, thermoplastic, thermoset plastic	1,200	-65°F to 300°F (-54°C to 149°C)	●
	3943™	36480 36478	25 ml syringe 1 liter bottle	Transparent to Hazy/Fluorescent	Ultraviolet, visible	Glass, metal, thermoplastic, thermoset plastic	6,000	-65°F to 300°F (-54°C to 149°C)	●
	3944™	38210 38212	25 ml syringe 1 liter bottle	Fluorescent/Pale Yellow	Ultraviolet, visible	Glass, metal, thermoplastic, polycarbonate, polyvinylchloride	5,000	-65°F to 300°F (-54°C to 149°C)	●
	3971™	36792 36805	25 ml syringe 1 liter bottle	Transparent to Hazy/Fluorescent	Ultraviolet, visible	Metal, thermoplastic, polyvinylchloride, polyurethane	320	-65°F to 300°F (-54°C to 149°C)	●
	3972™	36294 36295	25 ml syringe 1 liter bottle	Transparent to Hazy/Fluorescent	Ultraviolet, visible	Metal, thermoplastic, polyvinylchloride, polyurethane	4,500	-65°F to 300°F (-54°C to 149°C)	●
	3974™	1135733 1135732	25 ml syringe 1 liter bottle	Translucent/Colorless	Ultraviolet, visible	Thermoplastic, thermoset plastic, glass, metal, ceramic	2,000	-65°F to 300°F (-54°C to 149°C)	●
	3979™	1402562 1402563	25 ml syringe 300 ml cartridge	Translucent/Straw	Ultraviolet, visible	Polycarbonate, polyvinylchloride	142,080	-65°F to 300°F (-54°C to 149°C)	●
	ACRYLIC UV/VISIBLE WITHOUT FLUORESCENCE	3201™	19727 19728	25 ml syringe 1 liter bottle	Clear/Pale Straw	Ultraviolet, visible	Glass, metal, thermoplastic, polycarbonate	4,000	-65°F to 300°F (-54°C to 149°C)
3211™		19730 19731*	25 ml syringe 1 liter bottle	Clear/Pale Straw	Ultraviolet, visible	Glass, metal, thermoplastic, polycarbonate	10,000 Thixotropic	-65°F to 300°F (-54°C to 149°C)	●
3301™		19733 19734	25 ml syringe 1 liter bottle	Clear/Pale Straw	Ultraviolet, visible	Glass, metal, thermoplastic, polycarbonate, polyvinylchloride	150	-65°F to 300°F (-54°C to 149°C)	●
3311™		19736 19737	25 ml syringe 1 liter bottle	Clear/Pale Straw	Ultraviolet, visible	Glass, metal, thermoplastic, polycarbonate, polyvinylchloride	300	-65°F to 300°F (-54°C to 149°C)	●
3321™		19739 19740	25 ml syringe 1 liter bottle	Clear/Pale Straw	Ultraviolet, visible	Glass, metal, thermoplastic, polycarbonate, polyvinylchloride	5,000	-65°F to 300°F (-54°C to 149°C)	●

ITEMS IN RED = Source's PICK or NEW

* Made-to-order item.

Your Source for **MEDICAL APPLICATION SOLUTIONS**
CYANOACRYLATES, ACCELERATORS & PRIMERS

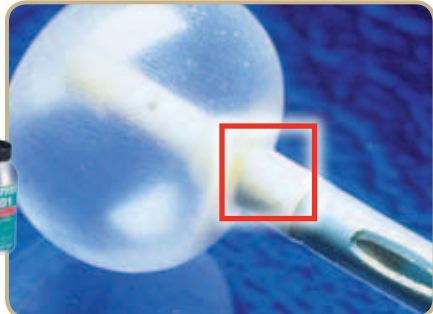
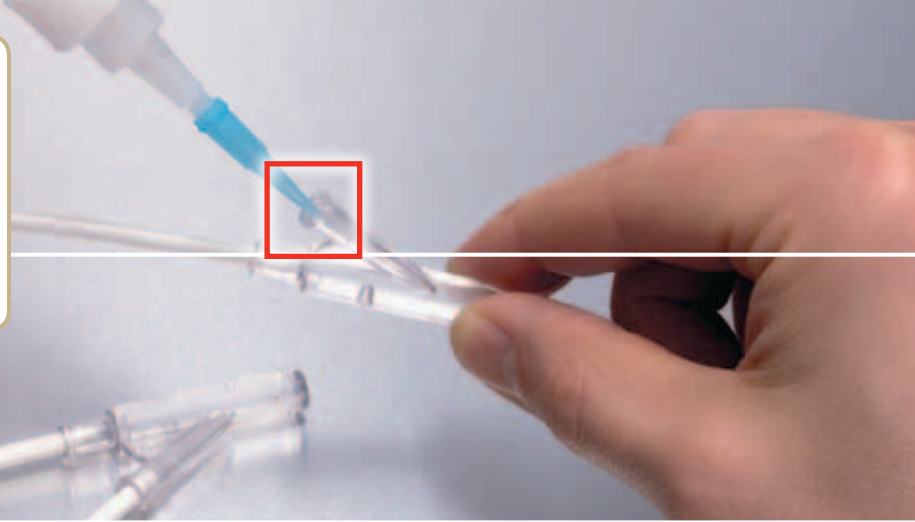

Sources **REVEALED**

[**Cyanoacrylates**]

Source's PICK **Loctite® 431™ Prism® Instant Adhesive**

A high viscosity, instant adhesive ideally suited for dry environments, as well as for bonding acidic and porous surfaces.

Item #	41254	3 g tube
	41255	20 g bottle
	41256	1 lb. bottle

Loctite® 435™ Prism® Instant Adhesive

SURFACE INSENSITIVE/TOUGHENED

The first true clear, surface insensitive, elastomer-modified instant adhesive. Faster fixture times over traditional toughened adhesives with exceptional bond and peel strength on metals, plastics and rubbers.

Item #	41005	3 g tube
	40994	20 g bottle
	40995	1 lb. bottle

Source's PICK **Loctite® 4011™ Prism® Medical Device Instant Adhesive**

A low viscosity, instant adhesive ideally suited for dry environments, as well as for bonding acidic surfaces.

Item #	18680	20 g bottle
	18681	1 lb. bottle

Source's PICK **Loctite® 4541™ Prism® Instant Adhesive**

GEL

Designed for the assembly of difficult-to-bond materials that require uniform stress distribution. Particularly suited for bonding porous or absorbent materials. Also formulated for faster cure speeds on dry or acidic surfaces and substrates.

Item #	21920	10 g syringe
	18690	20 g tube
	18691	200 g tube

Loctite® 4851™/4861™ Prism® Instant Adhesives

FLEXIBLE

Medium and high viscosity instant adhesives for the assembly of flexible components.

Item #	4851™	37732	20 g bottle
	4851™	37733	1 lb. bottle
	4861™	37708	20 g bottle
	4861™	37711	1 lb. bottle

[**Light Cure Cyanoacrylates**]

Source's PICK **Loctite® 4306™ Flashcure® Light Cure Adhesives**

Wicking grade fluorescent adhesive that achieves tack-free cure in less than 5 seconds. Surface versatile with shadow cure capability.

Item #	4306™	37439	1 oz. bottle
	4306™	37442	1 lb. bottle

Source's PICK **Loctite® 4310™/4311™ Flashcure® Light Cure Adhesives**

Low or high viscosity toughened fluorescent adhesives that achieve tack-free cures in less than 5 seconds. Surface versatile with shadow cure capability.

Item #	4310™	1401792	1 oz. bottle
	4310™	1401790	1 lb. bottle
	4311™	1401791	1 oz. bottle
	4311™	1401789	1 lb. bottle

[**Primers**]

Source's PICK **Loctite® 7701™ Prism® Medical Device Primer**

An adhesion promoter formulated for use with polyolefins and other low surface energy plastic materials. Use with Loctite® cyanoacrylate adhesives. Fast dry time and long on-part life.

Item #	19886	1.75 fl. oz. bottle
	19887	16 fl. oz. can

[Loctite® Medical Device Cyanoacrylates, Accelerators & Primers Properties Chart]

LOCTITE® PRODUCT	ITEM NUMBER	PACKAGE TYPE & SIZE	APPEARANCE/ CLARITY/COLOR	CURE TYPE	KEY SUBSTRATES	VISCOSITY (CP) BROOKFIELD (25°C)	TEMPERATURE RANGE	ISO® 10993 COMPLIANT	
431™ PRISM® (SI)	41254 41255 41256	3 g tube 20 g bottle 1 lb. bottle	Clear	Humidity	Thermoplastic, thermoset plastic, metal, elastomer, including rubber	1,000	-65°F to 180°F (-54°C to 82°C)	●	
435™ PRISM® (T)	41005 40994 40995	3 g tube 20 g bottle 1 lb. bottle	Clear	Humidity	Thermoplastic, thermoset plastic, metal, elastomer, including rubber	200	-65°F to 240°F (-54°C to 116°C)	●	
4011™ PRISM® (SI)	18680 18681	20 g bottle 1 lb. bottle	Clear	Humidity	Thermoplastic, thermoset plastic, metal, elastomer, including rubber	100	-65°F to 180°F (-54°C to 82°C)	●	
4013™ PRISM® (GP)	20268 18013	20 g bottle 1 lb. bottle	Clear	Humidity	Thermoplastic, thermoset plastic, metal	500	-65°F to 180°F (-54°C to 82°C)	●	
4014™ PRISM® (GP)	20269 18014	20 g bottle 1 lb. bottle	Clear	Humidity	Thermoplastic, thermoset plastic, metal	3	-65°F to 220°F (-54°C to 104°C)	●	
4031™ PRISM® (LO)	18682 18683	20 g bottle 1 lb. bottle	Clear	Humidity	Thermoplastic, thermoset plastic, metal	1,300	-65°F to 160°F (-54°C to 71°C)	●	
4061™ PRISM® (SI)	18686 18687	20 g bottle 1 lb. bottle	Clear	Humidity	Thermoplastic, thermoset plastic, metal, elastomer, including rubber	20	-65°F to 180°F (-54°C to 82°C)	●	
4081™ PRISM® (LO)	18688	20 g bottle	Clear	Humidity	Thermoplastic, thermoset plastic, metal	5	-65°F to 160°F (-54°C to 71°C)	●	
4161™ SUPER BONDER® (GP)	19743 19744	20 g bottle 1 lb. bottle	Clear	Humidity	Thermoplastic, thermoset plastic, metal	1,500	-65°F to 180°F (-54°C to 82°C)	●	
4206™ PRISM® (TR)	28628 28629*	20 g tube 1 lb. bottle	Clear	Humidity	Thermoplastic, thermoset plastic, metal, elastomer, including rubber	375	-65°F to 250°F (-54°C to 121°C)	●	
4541™ PRISM® (SI)	18690 18691 21920	20 g tube 200 g tube 10 g syringe	Clear	Humidity	Thermoplastic, thermoset plastic, metal, elastomer, including rubber	Gel	-65°F to 180°F (-54°C to 82°C)	●	
4601™ PRISM® (LO)	18692 18693	20 g bottle 1 lb. bottle	Clear	Humidity	Thermoplastic, thermoset plastic, metal	50	-65°F to 160°F (-54°C to 71°C)	●	
4851™ PRISM® (FL)	37732 37733	20 g bottle 1 lb. bottle	Clear	Humidity	Thermoplastic, thermoset plastic, metal, elastomer, including rubber	400	-65°F to 125°F (-54°C to 52°C)	●	
4861™ PRISM® (FL)	37708 37711	20 g bottle 1 lb. bottle	Clear	Humidity	Thermoplastic, thermoset plastic, metal, elastomer, including rubber	4,000	-65°F to 125°F (-54°C to 52°C)	●	
4981™ SUPER BONDER® (TR)	18694 18695	20 g bottle 1 lb. bottle	Clear	Humidity	Thermoplastic, thermoset plastic, metal, elastomer, including rubber	500	-65°F to 220°F (-54°C to 104°C)	●	
LIGHT CURE CYANOACRYLATES	4306™ FLASHCURE®	37439 37442	1 oz. bottle 1 lb. bottle	Clear/ Pale Green	Ultraviolet, visible, humidity	Thermoplastic, polycarbonate, elastomer, metal	20	-65°F to 180°F (-54°C to 82°C)	●
	4310™ FLASHCURE®	1401792 1401790	1 oz. bottle 1 lb. bottle	Clear/ Pale Green	Ultraviolet, visible, humidity	Thermoplastic, polycarbonate, elastomer, metal	150	-65°F to 240°F (-54°C to 116°C)	●
	4311™ FLASHCURE®	1401791 1401789	1 oz. bottle 1 lb. bottle	Clear/ Pale Green	Ultraviolet, visible, humidity	Thermoplastic, polycarbonate, elastomer, metal	900	-65°F to 240°F (-54°C to 116°C)	●
ACCELERATOR & PRIMERS	713™ PRISM® ACCELERATOR	19889	1.75 fl. oz. bottle	Clear	N/A	Isopropanol-based accelerator for cyanoacrylates	1	N/A	●
	7451™ PRISM® ACCELERATOR	19890	1.75 fl. oz. bottle	Clear	N/A	Acetone-based accelerator for cyanoacrylates	1	N/A	●
	7701™ PRISM® PRIMER	19886 19887	1.75 fl. oz. bottle 16 fl. oz. can	Clear	N/A	Heptane-based adhesion promoter for low energy surface plastics	3	N/A	●

ITEMS IN RED = Source's PICK or NEW

(SI) – Surface Insensitive
(GP) – General Purpose

(LO) – Low Odor/Low Bloom
(FL) – Flexible

(TR) – Thermally Resistant
(T) – Toughened

* Made-to-order item.

Your Source for **MEDICAL APPLICATION SOLUTIONS**
EPOXIES, SILICONES & URETHANES

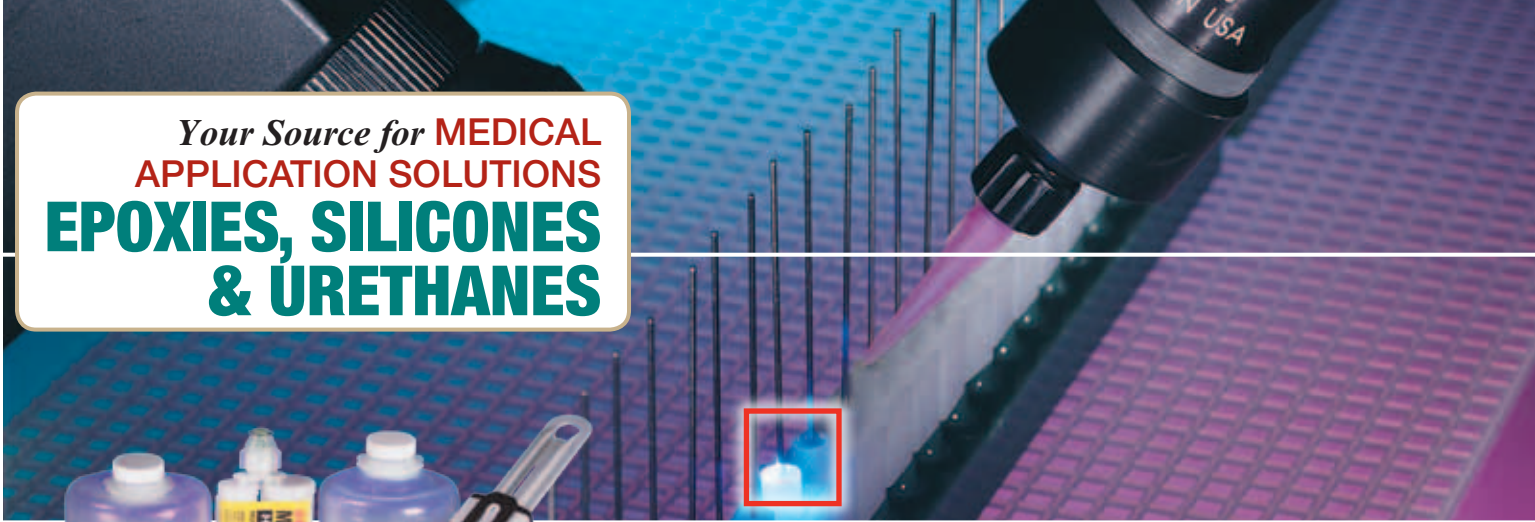

[Epoxies]

Source's PICK

**Loctite® 3981™/3982™/3984™
Hysol® Epoxy Adhesives**

**HIGH PERFORMANCE/
VARIOUS SUBSTRATES**
 Highly fluorescent, one-part, heat cure epoxy adhesives offering superior physical, environmental and performance properties.

Item #	3981™	36766	30 ml syringe
	3981™	37297	1 liter bottle
	3982™	36767	30 ml syringe
	3982™	37298	1 liter bottle
	3984™	36768	30 ml syringe
	3984™	37299*	1 liter bottle

**Loctite® M-21HP™ Hysol®
Medical Device Epoxy Adhesive**

An off-white, toughened epoxy that provides high peel resistance and high shear strength on a wide variety of plastics and metals.

Item #	30671	50 ml dual cartridge
--------	-------	----------------------

Source's PICK

**Loctite® M-31CL™ Hysol®
Medical Device Epoxy Adhesive**

A low viscosity epoxy that bonds glass, ceramic, metal and many rigid plastics. Ideal for applications where optical clarity and excellent structural and mechanical properties are required.

Item #	30673	50 ml dual cartridge
	30674*	200 ml dual cartridge

**Loctite® M-121HP™ Hysol®
Medical Device Epoxy Adhesive**

A high viscosity, non-sag epoxy for applications that require high impact resistance and high peel strength. Bonds dissimilar materials including aluminum, steel and other metals, as well as a variety of plastics and ceramics.

Item #	30680	50 ml dual cartridge
--------	-------	----------------------

[Silicone Adhesives/Sealants]

**Loctite® 5055™ Silicone
Adhesive Sealant**

SELF-LEVELING/FLOWABLE

A UV or visible light curing, noncorrosive silicone for high speed coating, potting adhesion or sealing applications. High adhesion for difficult-to-bond substrates.

Item #	1212167	25 ml syringe
	1214246	1 liter bottle
	1214247	15 liter pail*

**Loctite® 5056™ Silicone
Adhesive Sealant**

SELF-LEVELING/HIGH ADHESION

A UV or visible light curing, noncorrosive silicone with very high bond strength. Ideal for high speed adhesion and sealing applications. High adhesion for difficult-to-bond substrates.

Item #	1214249	25 ml syringe
	1214250	1 liter bottle
	1214248	15 liter pail*

Source's PICK

**Loctite® 5240™ Nuva-Sil®
Medical Device Sealant**

A self-leveling, UV or visible light silicone that also features a secondary moisture cure. Makes transparent, white-tinted seals or bonds.

Item #	1010341	25 ml syringe
	1010320	300 ml cartridge
	1010343	40 lb. pail*

[Urethane]

**Loctite® M-11FL™ Hysol®
Medical Device Urethane Adhesive**

A low viscosity urethane that bonds polycarbonate and a variety of other plastics, glass and metal. When fully set, product forms an ultra-clear bond line and provides excellent peel strength.

Item #	30678	50 ml dual cartridge
--------	-------	----------------------

* Made-to-order item.

Sources REVEALED

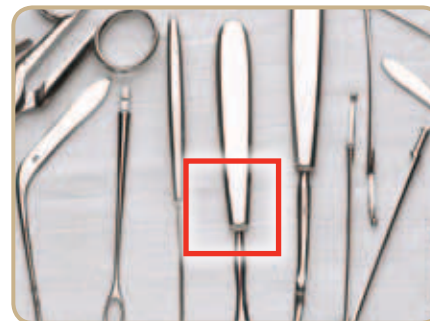
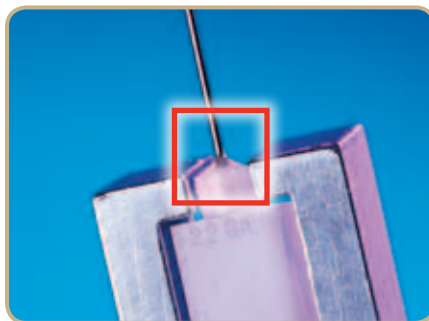

[Loctite® Epoxies, Silicones & Urethanes Properties Chart]

LOCTITE® PRODUCT	ITEM NUMBER	PACKAGE TYPE & SIZE	APPEARANCE/ CLARITY/COLOR	CURE TYPE	KEY SUBSTRATES	VISCOSITY (cP) BROOKFIELD (25°C)	TEMPERATURE RANGE	ISO® 10993 COMPLIANT	
EPOXIES	3981™ HYSOL®	36766 37297	30 ml syringe 1 liter bottle	Transparent Yellow	Heat cure	Thermoset plastic, metal, glass, ceramic	5,300	-65°F to 300°F (-54°C to 149°C)	●
	3982™ HYSOL®	36767 37298	30 ml syringe 1 liter bottle	Off-White	Heat cure	Thermoset plastic, metal, glass, ceramic	8,000	-65°F to 300°F (-54°C to 149°C)	●
	3984™ HYSOL®	36768 37299*	30 ml syringe 1 liter bottle	Light Grey	Heat cure	Thermoset plastic, metal, glass, ceramic	25,500	-65°F to 300°F (-54°C to 149°C)	●
	M-21HP™ HYSOL®	30671	50 ml dual cartridge	Off-White	Room temperature	Thermoplastic, thermoset plastic, elastomer, metal, glass, ceramic	37,000	-65°F to 300°F (-54°C to 149°C)	●
	M-31CL™ HYSOL®	30673 30674*	50 ml dual cartridge 200 ml dual cartridge	Ultra-Clear	Room temperature	Thermoplastic, thermoset plastic, polycarbonate, metal, glass, ceramic	6,000	-65°F to 300°F (-54°C to 149°C)	●
	M-121HP™ HYSOL®	30680	50 ml dual cartridge	Amber	Room temperature	Thermoplastic, polycarbonate, polyvinylchloride, metal, glass, ceramic	11,000	-65°F to 300°F (-54°C to 149°C)	●
SILICONE ADHESIVE/SEALANTS	5240™ NUVA-SIL®	1010341 1010320 1010343*	30 ml syringe 300 ml cartridge 40 lb. pail	Translucent/White	UV/visible, humidity	Silicone, metal, glass, plastic	18,000	-65°F to 200°F (-54°C to 93°C)	●
	5055™	1212167 1214246 1214247*	25 ml syringe 1 liter bottle 15 liter pail	Light Yellow/ Transparent	UV/visible	Silicone, metal, glass, plastic	525	-65°F to 200°F (-54°C to 93°C)	●
	5056™	1214249 1214250 1214248*	25 ml syringe 1 liter bottle 15 liter pail	Light Yellow/ Transparent	UV/visible	Silicone, metal, glass, plastic	2,200	-65°F to 200°F (-54°C to 93°C)	●
URETHANE	M-11FL™ HYSOL®	30678	50 ml dual cartridge	Ultra-Clear	Room temperature	Thermoplastic, thermoset plastic, polycarbonate, elastomer, metal, glass, ceramic	3,800	-65°F to 250°F (-54°C to 121°C)	●

ITEMS IN RED = Source's PICK or NEW * Made-to-order item.



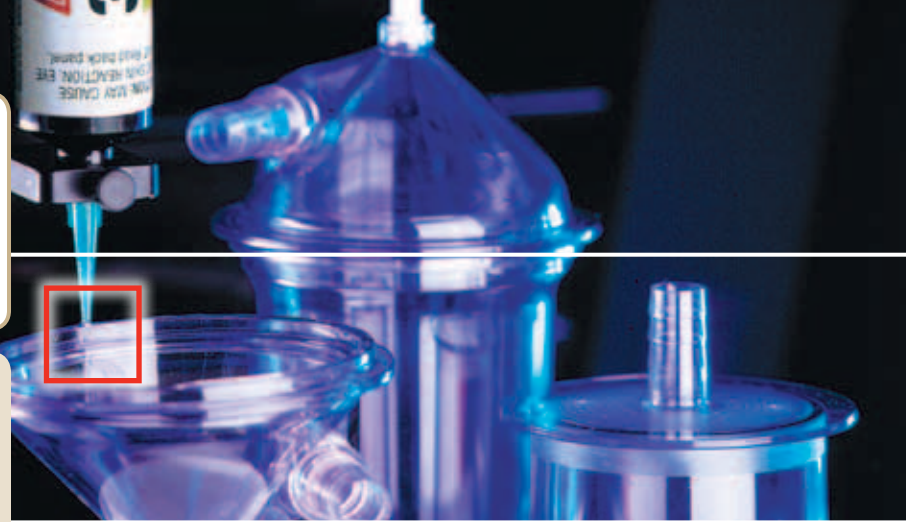

Your Source for **MEDICAL APPLICATION SOLUTIONS**
MEDICAL CURING EQUIPMENT





YOUR EQUIPMENT Source

For more details, see the **Loctite® Equipment Sourcebook, LT-3669**, or visit us on the web for additional information, diagrams, products and our full line of equipment at www.equipment.loctite.com.

LOCTITE® PRODUCT		ITEM NUMBER	LAMP TYPE
ENCLOSED CHAMBER & FLOOD SYSTEMS			
	UVALOC 1000 UV CURE CHAMBER	805741	1,000 watt Mercury Vapor
	ZETA® 7401 UV CHAMBER	98039	400 watt Metal Halide
	ZETA® 7411-S UV FLOOD SYSTEM	98413	400 watt Metal Halide
	FOCUSED UV FLOOD CURING SYSTEM NEW 2008	1113131	400 watt Metal Halide
	ZETA® INDIGO® 7418 VISIBLE FLOOD SYSTEM	971031	400 watt Visible Arc Lamp

LOCTITE® PRODUCT		ITEM NUMBER	LAMP TYPE
CURE CONVEYORS			
	ZETA® 7415 UV BENCHTOP CONVEYOR	98003	300 W/in Electrodeless (sold separately)
	UV BENCHTOP CONVEYOR	1241543	1,800 watt Medium Pressure Mercury Arc Lamp
LIGHT SOURCES			
	ELECTRODELESS LAMP ASSEMBLY AND POWER SUPPLY	98004 (208/240 VAC)	300 W/in Electrodeless
	HIGH INTENSITY ULTRAVIOLET SOURCES	980160	1,500 watt Medium Pressure Mercury Arc Lamp

LOCTITE® PRODUCT		ITEM NUMBER	MEASUREMENT RANGE
LIGHT METERS			
	UV-BA DOSIMETER-RADIOMETER	1390323	320 to 400 nm
	UV-V DOSIMETER-RADIOMETER	1265282	390 to 600 nm
	UV SPOT-7020 RADIOMETER	1406024	280 to 400 nm/3, 5, and 8 mm light guides

ITEMS IN RED = Source's PICK or NEW

LOCTITE® BRANDED EQUIPMENT – Loctite® is a full service supplier of equipment and offers a wide variety of equipment services to its customers. **For more Loctite® branded equipment, go to page 171.**

Can't find what you're looking for? Visit www.equipment.loctite.com or call 1-800-LOCTITE (562-8483).

STRAIGHT FROM The Source



WEAR EYE PROTECTION

For proper eye protection, use Loctite® brand ultraviolet safety glasses.



Item No. 97210

Item No. 98452

ADDITIONAL
RESOURCES





LOCTITE® PRODUCT		ITEM NUMBER	LAMP TYPE	OPTIONS/ACCESSORIES
LIGHT CURE SYSTEMS	LED CURING DEVICES			
	 7700 LED LIGHT SOURCE II	1427231	LED – 395 nm	OPTIONAL: • Timer - 98443; • Foot Switch - 98440; • Holder - 98522; • Dosimeter - 98089; • Dosimeter Adapter - 98453
	 7703 LED LIGHT SOURCE	98595	LED – Indigo Wavelength	
	 7700-HD LED LIGHT SOURCE II	1427232	LED – 395 nm	ONE OF THE FOLLOWING IS REQUIRED: • Timer - 960356; • PLC Cable - 8900550; • Foot Switch - 97201; • Pistol Grip Timer - 1003327
	 7703-HD LED LIGHT SOURCE	883979	LED – Indigo Wavelength	
	 LED FLOOD ARRAY – 375	1167582	LED – 375 nm	Used with 1359255 in conjunction with cable 1333333
	 LED FLOOD ARRAY – INDIGO®	1167589	LED – Indigo Wavelength	Used with 1359255 in conjunction with cable 1333333
	 LED FLOOD ARRAY – 405	1167593	LED – 405 nm	Used with 1359255 in conjunction with cable 1333333
	 LED FLOOD CONTROLLER	1359255	N/A	Used with all LED Flood Arrays
	 CUREJET™ 375 LED	1369539	LED – 375 nm	Used with 1364033 or 1180632
	 CUREJET™ 405 LED	1369538	LED – 405 nm	Used with 1364033 or 1180632
	 CUREJET™ INDIGO® LED	1369537	LED – Indigo Wavelength	Used with 1364033 or 1180632
	 SINGLE CUREJET™ CONTROLLER	1364033	N/A	Used with all CUREJET™ LEDs
	 CUREJET™ QUAD CONTROLLER	1180632	N/A	Used with all CUREJET™ LEDs
WAND SYSTEMS				
 LOCTITE® 100W WAND SYSTEM	1377200	100 watt High Pressure Mercury Arc	ONE OF THE FOLLOWING IS REQUIRED: • Light Guide 5 mm x 1,000 mm – 986377; • Light Guide 5 mm x 1,500 mm – 951681; • For other Light Guide options, visit www.equipment.loctite.com	
 ZETA® 760A UV WAND SYSTEM	1329221	200 watt High Pressure Mercury Arc		



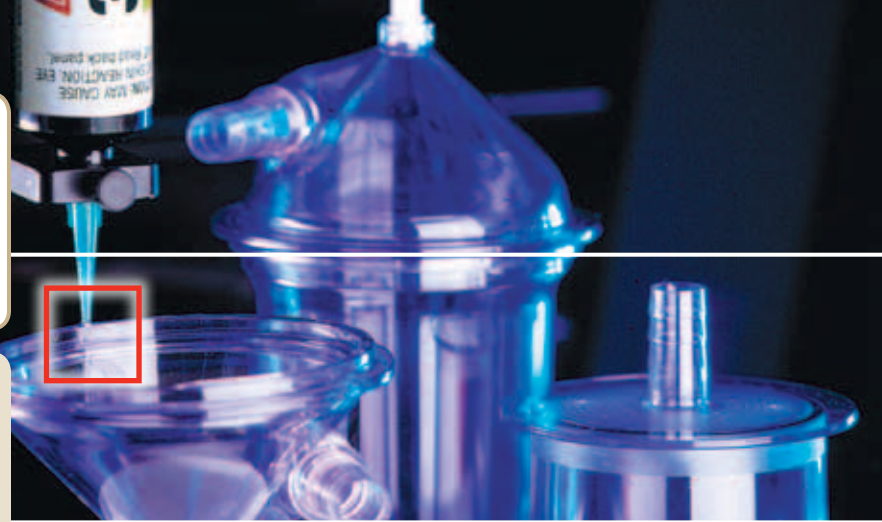

ITEMS IN RED = Source's PICK or NEW



Your Source for **MEDICAL APPLICATION SOLUTIONS**
MEDICAL DISPENSING EQUIPMENT



YOUR EQUIPMENT Source
 For more details, see the **Loctite® Equipment Sourcebook, LT-3669**, or visit us on the web for additional information, diagrams, products and our full line of equipment at www.equipment.loctite.com.







LOCTITE® PRODUCT		ITEM NUMBER	TYPE	VISCOSITY RANGE	DISPENSE PATTERNS	USED TO DISPENSE	STROKE ADJUSTMENT	SUCK-BACK	CONSUMABLES – DISPENSE ACCESSORIES		
HIGH PRECISION VALVES											
VALVES AND PUMPS		MICRO NEEDLE VALVE	98084	High Precision	Low to Medium	Drop, Dot, Bead, Microdot	Light Cure/Acrylics	Yes	No	Dispense Tips and Accessories – Pages 182-186	
	HIGH PERFORMANCE DIAPHRAGM VALVES										
		LIGHT CURE DISPENSE VALVE	98009	High Performance Diaphragm	Low to Medium	Drop, Dot, Bead	Instant Adhesives	Yes	No		
	CYANOACRYLATE DISPENSE VALVE	98013	High Performance Diaphragm	Low to Medium	Drop, Dot, Bead, Microdot	Instant Adhesives	Yes	No			

LOCTITE® PRODUCT		ITEM NUMBER	TYPE	VISCOSITY RANGE	DISPENSE PATTERNS	USED TO DISPENSE	STROKE ADJUSTMENT	ACTUATION	CONSUMABLES – DISPENSE ACCESSORIES		
GENERAL-PURPOSE APPLICATORS											
HANDHELD VALVES		LV HAND-HELD APPLICATOR	97130	Pneumatic	Low	Drop, Dot, Bead	Instant Adhesives	Yes	Foot	Dispense Tips and Accessories – Pages 182-186	
	GENERAL-PURPOSE APPLICATORS										
		MANUAL HAND-HELD APPLICATOR	97111	Manual	Low to Medium	Drop, Dot, Bead	Light Cure/Acrylics	Yes	Finger		
		PNEUMATIC HAND-HELD APPLICATOR	97112	Pneumatic	Low to Medium	Drop, Dot, Bead	Light Cure/Acrylics	Yes	Foot		
	PNEUMATIC HAND-HELD APPLICATOR	97116	Pneumatic	Low to Medium	Drop, Dot, Bead	Light Cure/Acrylics	Yes	Finger			
GENERAL-PURPOSE APPLICATORS											
	VARI-DROP™ APPLICATORS	97131 97132	Pinch Tube	Low to Medium	Drop, Dot, Bead	Instant Adhesives	Yes	Finger	Dispense Tips and Accessories – Pages 182-186		



LOCTITE® PRODUCT		ITEM NUMBER	USED TO DISPENSE	PACKAGE TYPE & SIZES	MIX RATIOS	VISCOSITY RANGE	TYPE	CONSUMABLES – DISPENSE ACCESSORIES	
SYRINGE DISPENSING									
HANDHELD APPLICATORS		30 ML MANUAL SYRINGE APPLICATOR	98026	Any fluid in 30 ml syringe including 25 ml syringes	30 ml syringe	N/A	Low to High	Manual	Dispense Tips and Accessories – Pages 182-186 Syringe Accessories – Pages 184
	TWO-PART DISPENSING								
	50 ML DUAL CARTRIDGE PNEUMATIC APPLICATOR	97042	Two-Component Epoxies, Urethanes	50 ml dual cartridge	1:1, 2:1, 10:1	Low to High	Pneumatic		

LOCTITE® BRANDED EQUIPMENT – Loctite® is a full service supplier of equipment and offers a wide variety of equipment services to its customers. **For more Loctite® branded equipment, go to page 171.**
 Can't find what you're looking for? Visit www.equipment.loctite.com or call 1-800-LOCTITE (562-8483).

STRAIGHT FROM *The Source*

LOCTITE® PRODUCT		ITEM NUMBER	DISPENSE PATTERNS	USED TO DISPENSE	PACKAGE TYPES & SIZES	VISCOSITY RANGE	VACUUM SUCK-BACK	CONSUMABLES – DISPENSE ACCESSORIES	
DISPENSE SYSTEMS	VOLUMETRIC BOTTLE DISPENSING								
		BENCHTOP PERISTALTIC DISPENSER	98548	Dot, Drop, Bead	Instant Adhesives, Light Cure/Acrylics	Any	0 to 5,000 cP	N/A	Dispense Tips and Accessories – Pages 182-186
	COMPLETE PRESSURE-TIME BOTTLE DISPENSE SYSTEM								
		BOND-A-MATIC® 3000 DISPENSER 0-15 psi	982719	Dot, Drop, Bead	Gel Adhesives, Instant Adhesives, Light Cure/Acrylics	200 ml bottle 1 lb. bottle 1 liter bottle 2 kg bottle 200 g squeeze tube	Low	N/A	Dispense Tips and Accessories – Pages 182-186
		BOND-A-MATIC® 3000 DISPENSER 0-100 psi	982722						
	SYRINGE DISPENSING SYSTEMS								
		POSI-LINK™ DISPENSING SYSTEM	See Page 183	Dot, Drop, Bead	Gel Adhesives, Instant Adhesives, Light Cure/Acrylics, Epoxies	Prepackaged 5 ml syringe 10 ml syringe 25 ml syringe	Low to Paste	Yes	Dispense Tips and Accessories – Pages 184-185
		PRECISION SYRINGE DISPENSING SYSTEM	97006*	Dot, Drop, Bead	Gel Adhesives, Instant Adhesives, Light Cure/Acrylics	3 ml syringe 5 ml syringe 10 ml syringe 30 ml syringe 55 ml syringe	Low to Paste	Yes	Syringe Accessories – Page 184
		DIGITAL SYRINGE DISPENSING SYSTEM	883976					Yes	
	TUBE BONDING								
	LIGHT CURE ACRYLIC ADHESIVE DISPENSING SYSTEM	98445	Beads on tubing OD	Light Cure/Acrylics	2.0 mm to 6.0 mm ID tubing	Low	N/A		

* Syringe Airline Adapter sold separately. Visit www.equipment.loctite.com for all available accessories.

LOCTITE® PRODUCT		ITEM NUMBER	PRESSURE REGULATION	USED TO DISPENSE	PACKAGE TYPES & SIZES	VISCOSITY RANGE	LOW LEVEL SENSING	FOR MORE INFORMATION		
CONTROLLERS & RESERVOIRS	INTEGRATED RESERVOIR CONTROLLERS									
		INTEGRATED SEMI-AUTOMATIC DISPENSER	1390322	0 to 15 psi	Gel Adhesives, Instant Adhesives, Light Cure/Acrylics	250 ml bottle 1 lb. bottle 1 liter bottle 2 kg bottle 200 g squeeze tube	Low to Medium	Yes	Dispense Tips and Accessories – Pages 182-186	
			1390321	0 to 100 psi				Medium to High		Yes
	RESERVOIRS									
		BOND-A-MATIC® 3000 RESERVOIR	982720	0 to 15 psi	Gel Adhesives, Instant Adhesives, Light Cure/Acrylics	250 ml bottle 1 lb. bottle 1 liter bottle 2 kg bottle 200 g squeeze tube	Low to Medium	Yes	Dispense Tips and Accessories – Pages 182-186	
			982726					No		
			982723	0 to 100 psi				Medium to High		Yes
			982727					No		

ITEMS IN RED = Source's PICK or NEW

Your Source for EQUIPMENT

[Table of Contents]

EQUIPMENT	171
CONTROLLERS & RESERVOIRS	173
LIGHT CURE EQUIPMENT	173
HANDHELD APPLICATORS	174
HANDHELD VALVES	174
DISPENSE SYSTEMS	174
VALVES & PUMPS	175
TWO-PART VOLUMETRIC DISPENSING	175
HOT MELTS EQUIPMENT	176
MOTION CONTROL ROBOT DISPENSE SYSTEM	176
CONSUMABLES – DISPENSE ACCESSORIES	176
MOTION CONTROL ROBOT DISPENSE SYSTEM	177
TWO-PART VOLUMETRIC DISPENSING	
LOCTITE® POSI-LINK™ DISPENSE SYSTEM FOR DUAL CARTRIDGES	179
METER MIX SYSTEMS	181
CONSUMABLES – DISPENSE ACCESSORIES	182

Since 1971, Henkel Corporation has designed, built and integrated high-quality equipment solutions. From simple handheld devices to fully automated systems, Henkel offers a complete line of standard off-the-shelf Loctite® brand dispensing and light curing equipment, which can be integrated easily into your manufacturing process.

AS A FULL SERVICE SUPPLIER OF EQUIPMENT, HENKEL OFFERS A WIDE VARIETY OF EQUIPMENT SERVICES TO ITS CUSTOMERS.

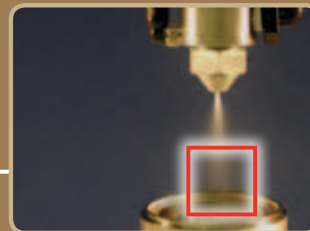

YOUR EQUIPMENT Source

For more details, see the **Loctite® Equipment Sourcebook, LT-3669**, or visit us on the web for additional information, diagrams, products and our full line of equipment at www.equipment.loctite.com.

FACTORY REPAIRS

If you have equipment in need of repair, Henkel can restore it to original operating specification. Customers often schedule preventive repairs to coincide with annual shutdowns. Henkel can work with you to get your equipment up and running in the fastest possible time frame. Rental equipment may be available on a short-term basis to minimize downtime.

Benefits of factory repair service include:

- Trained technicians evaluate equipment based on original design specifications to identify critical and preventive repair recommendations
- Equipment is repaired using original factory parts
- All equipment is fully tested to original quality specifications
- All repairs carry a 30-day labor and 90-day parts warranty

CALIBRATIONS

Henkel provides calibration services for all of its light meters. All meters are calibrated to original calibration standards. Data is collected before and after calibration, and a calibration certificate is issued that states the test results. In addition, you can sign up with Henkel for calibration reminders. Also, all units are inspected during calibration for any potential needed repairs.

FIELD SERVICE

Henkel technicians are available to travel to your location for repair services, preventive maintenance, training or assistance in setting up a new system. Whatever you need, Henkel can provide the service.

SPARE PARTS

Spare parts and accessories are available through the equipment services group of Henkel. Most common spare parts can be identified on our website at www.equipment.loctite.com. If you cannot find the part you are looking for, our equipment services group can help you identify that part and provide you with a quote.

REBUILD EXCHANGE PROGRAM

The Henkel rebuild exchange program offers customers a cost-effective way of streamlining the repair of dispensing valves. The rebuild program allows customers to send in an old valve and receive a reconditioned valve in return. Customers who participate in this program typically keep a spare valve in inventory, so if a valve goes down, it can be replaced immediately. The valve in need of repair is then sent to Henkel and a reconditioned valve is shipped back to the customer for future use.

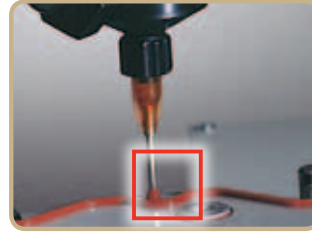
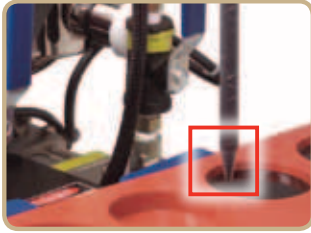

Advantages of the rebuild exchange program are:

- Rebuilt equipment is less than half the cost of a new unit.
- Rebuilt equipment is shipped in one to two business days.
- Highly trained technicians use original factory parts.
- All equipment is specially treated with a Henkel proprietary technology to prolong its useful life with reactive adhesives.
- All rebuilds carry a 30-day labor and 90-day parts warranty.

DISCOUNT EQUIPMENT

Henkel is able to offer a wide range of used or discontinued equipment at discounted prices. This equipment typically has been used in our rental program or has been used for customer demonstrations or trade shows. This equipment may have cosmetic blemishes but performs to original factory specification. All equipment carries the same warranty as new equipment, and is fully tested and reconditioned prior to sale.

EQUIPMENT RENTAL

Many of the equipment products that Henkel offers are available for short-term rental. Henkel's equipment rental program allows customers the flexibility to confirm the performance of our adhesive and equipment risk-free before investing in a purchase. If, during the first 30 days, you decide that you would like to purchase the rental equipment, the entire rental charge is credited toward your purchase.

The benefits of this program include:

- The performance of a new manufacturing process can be confirmed before investing fully in the purchase of equipment.
- Short production runs can be accommodated without having to buy equipment.
- Equipment can be rented during the repair of production equipment, minimizing any downtime.

LEASE-TO-OWN PROGRAM

Henkel offers a lease-to-own program for new equipment. According to the United States Equipment Lessors Association, 80% of all companies use leasing to acquire some or all of the machinery and equipment they use to run their businesses. Henkel's lease-to-own program provides an effective way for your business to acquire almost any Henkel equipment. Leases can be customized to each company's needs. Our program can also include other services and spare parts as part of the equipment lease. Let us customize a lease program to meet your needs.

PREVENTIVE MAINTENANCE CONTRACTS

There are many misconceptions about preventive maintenance. One such misconception is that preventive maintenance is unduly costly. This may be true for some components, but not all. Without preventive maintenance, costs for lost production time from unscheduled equipment breakdown will be incurred. Also, preventive maintenance will result in savings due to an increase in effective system service life.

Long-term benefits of preventive maintenance include:

- Improved system reliability
- Decreased cost of replacement
- Decreased downtime
- Better spare part inventory management

Henkel can create a preventive maintenance contract that fits your specific equipment and work with your maintenance staff to ensure maximum uptime of your equipment.

REQUEST EQUIPMENT SERVICES

On the Web

To learn more about the services Henkel offers, you can visit our website at www.equipment.loctite.com/service. In addition to our services, the website offers manuals and technical information on Loctite® equipment products.

Via Email

To request a quote or get more information, email your request to equipment-customerservice@loctite.com.

By Telephone

If you wish to speak to us regarding an equipment service, you can call 860-571-5174 to speak to an equipment services representative.

If you have a question regarding equipment setup or operation, our technical information staff is available to help. To contact a staff member, call 1-800-LOCTITE (562-8483) and choose the technical service option.

LOCTITE® EQUIPMENT WEBSITE

To better support our wide array of equipment services, our equipment website provides easy access to all service options and inquiries for all Loctite® equipment you may be interested in. Technical literature, equipment showroom locator, operational videos, and much more are all at your fingertips for quick and easy access. You can also choose to purchase directly online using a major credit card. Select from our wide array of adhesive dispensing and light curing equipment. Shipping time for most items is just one to two business days.

YOUR EQUIPMENT *Source*

www.equipment.loctite.com

Your Source for EQUIPMENT

YOUR EQUIPMENT *Source*

For more details, see the **Loctite® Equipment Sourcebook, LT-3669**, or visit us on the web for additional information, diagrams, products and our full line of equipment at www.equipment.loctite.com.



CROSS REFERENCE

We have provided you the **item numbers, name, and page numbers** for each piece of equipment listed on this page for **easy cross reference** to the adhesive sections found in this sourcebook.

HELPFUL HINTS

HENKEL OFFERS A WIDE VARIETY OF LOCTITE® EQUIPMENT & ACCESSORIES TO ITS CUSTOMERS

Below is an overview of the different types of Loctite® equipment and accessories that Henkel has to offer. For more details, you can find the items in the corresponding adhesives section, check out the **Loctite® Equipment Sourcebook, LT-3669**, or visit us on the web for additional information, diagrams, products and our full line of equipment at www.equipment.loctite.com.

[Controllers and Reservoirs]

Loctite® brand controllers and reservoirs can be used as the chief components, along with a selection of Loctite® brand parts and accessories or with your own parts, to create a complete custom dispensing system designed to meet your specific needs and manufacturing goals. Selection of a Loctite® brand controller and reservoir is based on the adhesive or fluid being used, the package or container the adhesive or fluid is supplied in, and the overall requirements of the manufacturing process.

Item #	Integrated Reservoir Controllers		For more information, see page number(s):
1390322	Integrated Semiautomatic Dispenser – 0 to 15 psi (Low Level Sensing)	12	
1390321	Integrated Semiautomatic Dispenser – 0 to 100 psi (Low Level Sensing)	12	
Reservoirs			
982720	Bond-A-Matic® 3000 Reservoir – 0 to 15 psi (Low Level Sensing – DC)	12	
982726	Bond-A-Matic® 3000 Reservoir – 0 to 15 psi	12	
982723	Bond-A-Matic® 3000 Reservoir – 0 to 100 psi (Low Level Sensing – DC)	12	
982727	Bond-A-Matic® 3000 Reservoir – 0 to 100 psi	12	
98090	Shot Miser™ Reservoir – 1 Liter	12, 24	
982880	4 liter Gravity Feed Reservoir	131	
Multifunction Controllers			
97152	Dual Channel Automatic Controller	11, 25	
1022006	Digital Multifunctional Controller	11, 25	
Single Function Controllers			
97101	Digital Dispense Controller	11, 25	
98079	Shot Miser™ Valve Controller	11, 24, 25	
1406023	Spray Valve Digital Controller	11	

[Light Cure Equipment]

Henkel offers the widest selection of light curing equipment available from any one company on the market today. Our Loctite® brand ensures you have the most innovative and dependable systems for all your light curing adhesive applications. Whether your process calls for a manual, semiautomatic or fully integrated automatic solution, you will find the Loctite® brand light curing device to meet your specific requirements. Please see the charts below that summarize our complete line.

Item #	Light Cure Point Systems – LED Curing Devices		For more information, see page number(s):
1427231	7700 LED Light Source II	26, 168	
98595	7703 LED Light Source	26, 168	
1427232	7700-HD LED Light Source II	26, 168	
883979	7703-HD LED Light Source	26, 168	
1369538	CureJet™ 405 LED	26, 168	
1369537	CureJet™ Indigo® LED	26, 168	
1364033	LED Controller – Single Curejet™	26, 168	
1167582	LED Flood Array – UVA	26, 168	
1167589	LED Flood Array – Indigo®	26, 168	
1167593	LED Flood Array – 405	26, 168	
1180632	CureJet™ Quad Controller	26, 168	
1359255	LED Flood Controller	26, 168	
Light Cure Point Systems – Wand Systems			
1377200	Loctite® 100W Wand System	26, 168	
1329221	Zeta® 760A UV Wand System	26, 168	
Light Cure Flood Systems – Enclosed Chamber & Flood Systems			
805741	UVALOC 1000 UV Cure Chamber	25	
98039	Zeta® 7401 UV Chamber	25	
98413	Zeta® 7411-S UV Flood System	25	
1113131	Focused UV Flood Curing System	25	
971031	Indigo® 7418 Visible Flood System	25	
98060	Zeta® 7420 Visible Light Flood System – 115V	25	
Light Cure Flood Systems – Cure Conveyors			
98003	Zeta® 7415 UV Benchtop Conveyor	25	
1241543	UV Benchtop Conveyor	25	
Light Cure Flood Systems – Light Sources			
98004	Electrodeless Lamp Assembly and Power Supply	25	
980160	High Intensity Ultraviolet Sources	25	
Light Cure Meters			
1265282	UV-V Dosimeter-Radiometer	25	
1390323	UV-BA Dosimeter-Radiometer	25	
1406024	UV Spot-7020 Radiometer	25	

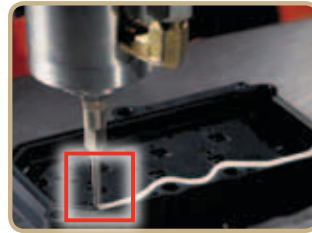

[Handheld Applicators]

Loctite® brand handheld applicators are ergonomically designed for the hand delivery of adhesives and fluids directly from their original package. Whether pneumatic or manual, each item is designed for the simple, clean, handheld dispensing of fluids, and to reduce waste and operator contact over other methods. Selection of a Loctite® brand handheld applicator is based on product type, package configuration and process requirements.

For more information, see page number(s):

Item #	Bottle Dispensing	
98414	50 ml Hand Pump	131, 155
97001	250 ml Hand Pump	131, 155
98345	Soft Squeeze Bottle – 2 fl. oz.	11, 131, 155
98346	Soft Squeeze Bottle – 4 fl. oz.	11, 131, 155
98347	Soft Squeeze Bottle – 8 fl. oz.	11, 131, 155
Syringe Dispensing		
1233800	10 ml Gel CA Syringe Dispenser	10
1233798	Replacement Plunger (For standard 0.5 in. diameter syringes)	10
98026	30 ml Manual Syringe Applicator	23, 34, 49, 169
98193	30 ml Syringe Manual Plunger, 3 Pack	34, 49
Tube Dispensing		
1083845	50 ml-F Tube Squeeze Dispenser	131, 155
Two-Part Dispensing		
98472	50 ml Dual Cartridge Manual Applicator – 1:1, 2:1	34, 38, 50, 122, 123
1034026	50 ml Dual Cartridge Manual Applicator – 10:1	34, 38, 50
97042	50 ml Dual Cartridge Pneumatic Applicator	34, 38, 50, 174
98466	Caulking Gun Conversion Kit for 50 ml Cartridges	34, 38, 50
98415	Caulking Gun Conversion Kit for 50 ml Cartridges	34, 38, 50
983436	200 ml Dual Cartridge Manual Applicator	34, 38, 50
983438	400 ml Dual Cartridge Manual Applicator	34, 38, 50
985246	400 ml Dual Cartridge Manual Applicator	34, 38, 50
983437	200 ml Dual Cartridge Pneumatic Applicator	34, 38, 50
983439	400 ml Dual Cartridge Pneumatic Applicator	34, 38, 50
985249	400 ml Dual Cartridge Pneumatic Applicator	34, 38, 50
1093940	Heavy Duty Manual Cartridge Applicator – 300 ml	69, 87
1093981	Heavy Duty Manual Cartridge Applicator – 600 ml	69
1372751	Universal Fixmaster® Dispenser	34, 38, 50, 119, 120

* 10 ml Syringe Manual Plunger (Item # 98192) available at www.equipment.loctite.com

[Handheld Valves]

Loctite® brand handheld dispensing valves are used where ergonomic design for hand dispensing of fluids is desired. Designed for use with Loctite® brand controllers and reservoirs, these handheld valves use passive wetted components for universal compatibility with many fluids. Selection of a Loctite® brand handheld valve is based on the desired dispensing controls, the dispense principal of the delivery system and other process requirements.

For more information, see page no.:

Item #	Low Viscosity Cyanoacrylate Applicator	
97130	LV Handheld Applicator	11, 132, 156, 169
General-Purpose Applicators		
97111	Manual Handheld Applicator	23, 132, 156, 169
97112	Pneumatic Handheld Applicator – Foot Activated	23, 132, 156, 169
97116	Pneumatic Handheld Applicator – Finger Activated	23, 132, 156, 169
Syringe Dispense Systems		
97131	Vari-Drop™ Applicator – with PTFE tubing	11, 132, 156, 169
97132	Vari-Drop™ Applicator – without PTFE tubing	11, 132, 156, 169

[Dispense Systems]

Loctite® brand dispense systems available from Henkel are designed to offer the total package for fluid delivery. Whether you use a Loctite® brand adhesive product, or any other brand, these complete systems are ready for immediate operation and offer the manufacturing flexibility and reliability you're seeking. Selection of a Loctite® brand complete dispensing system is based on the product being used, package size and process requirements.

For more information, see page number(s):

Item #	Volumetric Bottle Dispensers	
98548	Benchtop Peristaltic Dispenser	12, 24, 132, 156, 170
Complete Pressure-Time Bottle Dispense Systems		
982719	Bond-A-Matic® 3000 Dispenser – 0-15 psi	12, 24, 132, 156, 170
982722	Bond-A-Matic® 3000 Dispenser – 0-100 psi	12, 24, 132, 156, 170
98079	Shot Miser™ Valve Controller	11, 12, 24, 132, 156
98085	Shot Miser™ Dispense Valve	11, 12, 24, 132, 156
98090	Shot Miser™ Reservoir	12, 24, 132, 156
Pneumatic Cartridge Dispensing		
1294304	Pneumatic Handheld 300 ml Dispenser	12, 24, 28, 49, 78, 80, 88, 90, 113
98022	300 ml Cartridge Pusher	12, 24, 78, 88, 113
98319A	300 ml Pneumatic Cartridge Dispensing Retainer	12, 24, 49, 78, 88, 113
1046901	High Pressure 300 ml Benchtop Cartridge Dispenser	28, 49, 80, 88, 113
Syringe Dispense Systems		
98377	Posi-Link™ Dispensing System (Accessories Required)	179, 180
97006*	Precision Syringe Dispensing System	12, 24, 170
883976	Digital Syringe Dispensing System	12, 24, 170
98050	Foot Pedal Dispenser	12, 24
Thread Sealant & Anaerobic Gasketing Delivery Systems		
998400	Dial-A-Seal® Applicator	155
986000	Pump-A-Bead™ II Dispenser	78
Volumetric Bottle Dispensers		
98445	Light Cure Acrylic Adhesive Dispensing System	170

* Syringe Air-Line Adapter sold separately.

LOCTITE® HANDHELD VALVES FLUID CAPABILITY CHART	97130	97111	97112	97116	97131/97132
ACCELERATORS	•	•	•	•	•
ACRYLICS		•	•	•	•
ACTIVATORS	•	•		•	•
ANAEROBICS	•	•		•	•
CYANOACRYLATES	•				•
INKS	•	•	•	•	•
OILS		•	•		•
PAINTS		•	•	•	•
PRIMERS	•	•	•	•	•
REAGENTS	•	•			•
SOLVENTS	•				•
UV & LIGHT CURE FLUIDS		•	•	•	•
UV ANAEROBICS		•	•	•	•
WATER	•				

Your Source for EQUIPMENT

YOUR EQUIPMENT Source

For more details, see the **Loctite® Equipment Sourcebook, LT-3669**, or visit us on the web for additional information, diagrams, products and our full line of equipment at www.equipment.loctite.com.

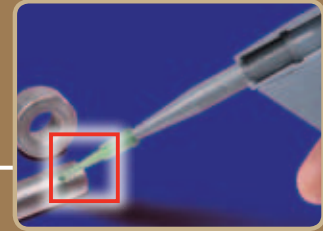
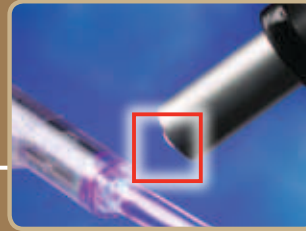

CROSS-REFERENCE

We have provided you with the **item numbers, name and page numbers** for each piece of equipment listed on this page for **easy cross-reference** to the sections where the equipment can be found.

HELPFUL HINTS

[Valves & Pumps]

Loctite® brand dispensing valves and pumps are value-added, robust, dispensing valves for adhesive or fluid delivery. Each valve is uniquely designed to meet different manufacturing needs. These valves should be combined with a reservoir and/or a controller. Selection of a Loctite® brand valve or pump is based on the chemistry and viscosity of the adhesive or fluid being used and process requirements.

For more information, see page number(s):

Item #	High Precision Valves		
97113	Stationary Applicator Valve – 1/4 in. Tube	11, 132, 156	
97114	Stationary Applicator Valve – 3/8 in. Tube	11, 132, 156	
98084	Micro Needle Valve	23, 169, 178	
High Performance Diaphragm Valves			
98009	Light Cure Dispense Valve	23, 132, 156, 169	
98013	Cyanoacrylate Dispense Valve	11, 132, 156, 169	
General Duty Diaphragm Valves			
97135	Diaphragm Valve	132, 156	
97136	Diaphragm Valve	132, 156	
Spray Valves			
98520	Spray Valve	139, 178	
High Viscosity Fluid & Paste Valves			
986300	Poppet Valve	78, 132, 156	
1049138	High Pressure Dispense Valve – 50 Bar	28, 80, 88, 113	
1153502	High Pressure Dispense Valve – 150 Bar	28, 80, 88, 113	
Pinch Tube Valve			
98085	Shot Miser™ Dispense Valve	11, 12, 24, 132, 156	
Positive Displacement Pump			
983330	Positive Displacement Pump	132, 156	

LOCTITE® VALVE & PUMP FLUID CAPABILITY CHART	97113/ 97114	98084	98009	98013	97135/ 97136	98520	986300	1049138	1153502	98085	983330
ACCELERATORS			•	•		•					•
ACRYLICS	•	•	•	•	•	•	•				•
ACTIVATORS			•	•		•					•
ANAEROBICS	•		•	•	•		•			•	•
ANAEROBIC GASKETING							•				
CYANOACRYLATES	•			•	•						•
INKS	•	•	•	•	•	•					•
LUBRICANTS	•					•	•	•	•		
MODIFIED SILANES								•	•		
NON-ABRASIVE GREASES							•			•	
OILS	•		•	•	•			•			•
ONE-PART EPOXIES	•						•		•		
PAINTS	•		•	•	•	•					•
PRIMERS			•	•		•					•
REAGENTS			•	•		•					•
SILICONES								•	•		
SOLVENTS			•	•		•					•
UV & LIGHT CURE FLUIDS	•	•			•					•	•
UV ANAEROBICS	•		•	•	•						•
WATER		•	•	•	•	•					•

[Two-Part Volumetric Dispensing]

Loctite® Posi-Link™ Dispense System for Dual Cartridges

When you need high precision dispensing from your prepackaged dual cartridge adhesive, the Loctite® Posi-Link™ Dispense System is the solution. This system offers dispensing accuracy well beyond any pneumatic cartridge dispenser down to 0.001 ml drop size. Select your system based on cartridge size and adhesive ratio requirements.

Loctite® Posi-Link™ Dispense System for Dual Cartridges

For more information on Loctite® Posi-Link™ Dispense Systems, please refer to **page 179** where you can find information on the parts that make up the system, including the controller, actuator, dual cartridge nests, pinch tube valve and technical information.

Loctite® Meter Mix Systems*

When your Loctite® two-part adhesive application takes on a larger dimension, Henkel has the two-part volumetric dispensing solution with our high precision Loctite® Meter Mix Dispense Systems. You can choose either fixed or variable ratio units for any of our featured systems and, together with a wide selection of reservoir systems, hoses, valves and other accessories, customize your system to meet your application requirements.

For more information on Loctite® Meter Mix Systems, please refer to **page 181**.

* Requires special order through your local Henkel® sales rep.

Item # DuraPump™ Programmable Meter Mix System

1041649	1:1
1041644	2:1
1041639	4:1
1041638	10:1

DuraPump™ Pneumatic Meter Mix System

1041648	1:1
1041643	2:1
1041641	4:1
1041637	10:1

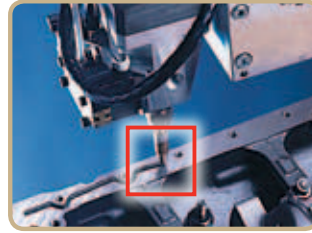
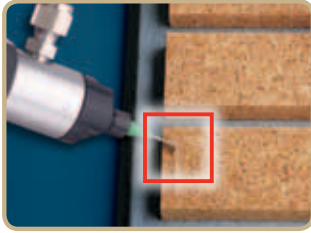

[Hot Melts Equipment]

Henkel offers Loctite® Hysol™ handheld hot melt applicators as well as Loctite® Hysol™ Bulk Hot Melt Systems.

Loctite® Hysol™ handheld hot melt applicators are state-of-the-art dispensing units designed for the application of hot melt adhesives. These units combine ergonomics, user-friendly design and reliability. Selection of a Loctite® Hysol™ hot melt applicator should be based on the type of hot melt being used, stick diameter and process requirements.

Loctite® Hysol™ bulk hot melt systems offer high performance control and reliability for all of your hot melt dispensing needs. You can rely on Henkel to supply you with performance hot melt adhesives as well as an array of standard high volume hot melt dispensing equipment. Henkel offers true one-stop shopping for your complete adhesive solution. These systems are rugged, compact and feature internal system diagnostics that monitor the temperatures and system settings.

Item #	Handheld Hot Melt Dispensers	For more information, see page number(s):
	1/2 in. Superstick Dispensers	
916282	Hysol™ 050A	17, 115
98545	Hysol™ 050-HT	17, 115
	3/4 in. Maxistick™ Dispensers	
98033	Hysol™ 075	17, 115
98034	Hysol™ 075-LT	17, 115
	1 3/4 in. SprayPac® and Polyshot Dispensers	
98036	Hysol™ 175-AIR	17, 115
98040	Hysol™ 175-AIR-HT	17, 115
98037	Hysol™ 175-SPRAY	17, 115
98041	Hysol™ 175-SPRAY-HT	17, 115
98035	Hysol™ 175	17, 115
	Urethane Dispenser	
98011	Hysol™ Reactive Urethane Cartridge Dispenser	17, 115
	Hot Melt Bench Mount and Controller Options	
98042	Hot Melt Bench Mount Kit	17, 115
98043	Hot Melt Pneumatic Timer	17, 115

Handheld Hot Melt Nozzles & Accessories

A complete listing of Hot Melt Nozzles and Accessories can be found on pages 18 and 116. For custom hot melt dispense nozzles, contact the Special Equipment Group of Henkel at 1-800-LOCTITE (562-8483).

[Motion Control Robot Dispense Systems]

Available in both Benchtop and SCARA model types, Loctite® brand robots are designed to simplify the dispensing of adhesives and sealants onto complex surface configurations. They allow manufacturers to dispense repeatedly and reliably patterns of liquid material on a programmed basis, resulting in improved process efficiencies, minimal material waste, and reduced manufacturing costs.

Benchtop Robots & SCARA Robot Station

For more information on Loctite® Motion Control Robot Dispense Systems, please refer to page 177, where you can find product listings, technical information, mounting hardware, workbenches and guarding systems.

[Consumables – Dispense Accessories]

Henkel offers a comprehensive line of Loctite® brand dispense tips, static mix nozzles and syringe barrel components. Our high precision stainless steel, tapered polyethylene and flexible polypropylene tips all feature a positive locking, helical thread design to ensure the tip will stay intact during the toughest applications. A wide variety of static mix nozzles are available to meet your two-part adhesive dispensing needs. High-quality syringe barrels and components will ensure consistent single-component adhesive dispensing needs are met.

Dispense Tips & Accessories

You can find a complete listing of Dispense Tips and Accessories on pages 182 and 183.

Cartridge Accessories

You can find a complete listing of Cartridge Accessories on page 183.

Static Mix Nozzles & Accessories

You can find a complete listing of Static Mix Nozzles and Accessories on pages 185 and 186.

Loctite® Brand Syringe Accessories

You can find a complete listing of Loctite® Brand Syringe Accessories on page 184.

Your Source for **EQUIPMENT** **MOTION CONTROL** **ROBOT DISPENSE SYSTEM**

YOUR EQUIPMENT *Source*

For more details, see the **Loctite® Equipment Sourcebook, LT-3669**, or visit us on the web for additional information, diagrams, products and our full line of equipment at www.equipment.loctite.com.





- Available in both Benchtop and SCARA model types
- Designed to simplify the dispensing of adhesives and sealants onto complex surface configurations
- Allows for repeated and reliable dispense patterns of liquid material on a programmed basis
- Improves process efficiencies
- Minimal material waste
- Reduces manufacturing costs

[Robot Types]

Benchtop robots are beam or gantry style robots designed to be placed on a bench. These robots carry one or more parts that are captured in a fixture that is mounted on the work surface. Motion in the X axis is achieved by moving the work surface forward and backward. The Y and Z axes are achieved by moving the tool head left and right and up and down, respectively, on the beam or gantry. When applicable, the fourth axis (R axis) is achieved by rotating the mounting shaft that protrudes from the tool head.

SCARA is an acronym for Selective Compliance Assembly Robot Arm. The robot is a multi-jointed arm that moves above the work surface. It must be mounted near the work surface by the user. The X and Y axes are achieved by changing the angles of the two arms. This creates a kidney-shaped dispensing area that is approximately 880 mm (34.6 in.) wide and 440 mm (17.3 in.) tall at the center. The Z axis is achieved by moving both arms up and down. On the 4-axis models, the R axis is achieved by rotating the mounting shaft that protrudes from the end of the arm.

ITEMS IN RED = *Source's PICK* or *NEW*

LOCTITE® PRODUCT		D-SERIES 200 BENCHTOP ROBOT STATION 	D-SERIES 300 BENCHTOP ROBOT STATION 	D-SERIES 400 BENCHTOP ROBOT STATION 	500 BENCHTOP ROBOT STATION 	S440 SCARA-N ROBOT STATION 
ITEM NUMBER (110 VOLT SYSTEMS)	3-AXIS	1328352	1452395	1452396	98602	1008351
	4-AXIS	98283A	98291A	98299A	98606	1008338
TYPE		Benchtop	Benchtop	Benchtop	Benchtop	SCARA
RANGE OF OPERATION	X AXIS	200 mm	300 mm	400 mm	510 mm	Arm 1: 260 mm ± 90°
	Y AXIS	200 mm	320 mm	400 mm	510 mm	Arm 2: 180 mm ± 150°
	Z AXIS	50 mm	100 mm	150 mm	150 mm	100 mm
	R AXIS	± 360°	± 360°	± 360°	± 360°	± 360°
PORTABLE WEIGHT LIMITATIONS	WORK SURFACE	5.0 kg	10.0 kg	10.0 kg	11.0 kg	N/A
	TOOL HEAD	2.0 kg	5.0 kg	5.0 kg	6.0 kg	5.0 kg
SPEED	PTP (X,Y) MAX.	400 mm/s	600 mm/s	600 mm/s	800 mm/s	1500 mm/s
	PTP (Z) MAX.	200 mm/s	320 mm/s	320 mm/s	320 mm/s	320 mm/s
	PTP (R)	6 to 600 %/s	8 to 800 %/s	8 to 800 %/s	8 to 800 %/s	10 to 1,000 %/s
	CP (X, Y, Z)	0.1 to 500 mm/s	0.1 to 800 mm/s	0.1 to 800 mm/s	0.1 to 800 mm/s	0.1 to 800 mm/s
ADDITIONAL INFORMATION		Please visit www.equipment.loctite.com for detailed drawings of all benchtop robots. Just search for the part number that you are interested in and scroll down to the product documentation.				

[Loctite® Brand Mounting Hardware, Workbenches & Guarding Enclosures]

Mounting Bracket Kits

Mounting bracket kits are used to grasp syringe barrels, Loctite® Posi-Link™ syringe and dual cartridge nests, 300 ml cartridges, dispense valves, and LEDs. Mounting rails or adapters are required to mount the brackets on the robot or dispense station.

Item #	98316	30 ml syringe mounting bracket kit
	98318	300 ml cartridge mounting bracket kit
	98326	98009 and 98013 valve mounting bracket kit
	98327	97113 and 97114 valve mounting bracket kit
	98406	983914 and 986300 poppet valve mounting bracket kit
	98441	98520 spray and 98084 micro needle valve mounting bracket kit
	98646	Universal syringe bracket for Posi-Link™
	98647	50 ml dual cartridge bracket for Posi-Link™
	98669	Handheld LED mounting bracket
	1034030	CureJet™ mounting bracket kit

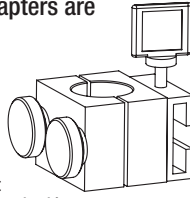

3, 5 and 10 ml Syringe Adapters

These adapters are inserted into the 30 ml syringe mounting bracket kit to adapt it for 3, 5 and 10 ml syringes. The 30 ml syringe mounting bracket (item 98316) must be purchased separately.

Item #	98320	10 ml adapter for use with 98316
	98321	5 ml adapter for use with 98316
	98322	3 ml adapter for use with 98316

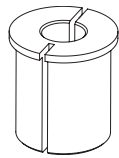

Mounting Adapter for All 4-Axis Robots

A mounting adapter is required when using Loctite® brand mounting hardware for all 4-axis robots. The mounting adapter includes a 360-degree rotation kit.

Item #	98336	Mounting adapter for 4-axis robots
--------	-------	------------------------------------

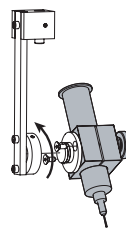

360-Degree Rotation Kit

This is used to allow for 360 degrees of rotation when using a mounting bracket kit or tip locator. A 360-degree rotation kit is already included with the mounting adapter for 4-axis robots.

Item #	98325	360-degree rotation kit
--------	-------	-------------------------

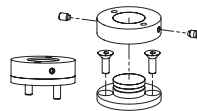

Complete Mounting Kits for 3-Axis SCARA Robots*

Complete mounting adapter kits hold the syringe, cartridge or valve, and position the dispense tip 60 mm from the end of the tool arm.

Item #	98340	30 ml syringe holder
	98341	300 ml cartridge holder
	98342	98009 and 98013 valve holder
	98343	97113 and 97114 valve holder
	98408	983914 and 986300 poppet valve holder

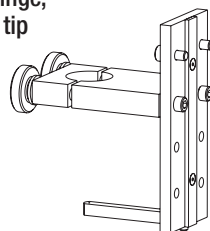

* These are sized for 25 gauge needles and must be modified by the user for larger gauge sizes.

Tip Locator Brackets*

Tip locator brackets position the dispense tip to increase precision and are used to mechanically set the tip height during installation. A mounting bracket and rail, plate, or adapter must be purchased separately.

Item #	98332	Tip locator bracket for 30 ml syringes
	98333	Tip locator bracket for 300 ml cartridges
	98334	Tip locator bracket for 98009 and 98013 valves
	98335	Tip locator bracket for 97113 and 97114 valves
	98407	Tip locator bracket for 983914 and 986300 poppet valve

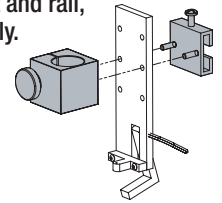

* These are sized for 1 in., 25 gauge stainless steel needles and must be modified by the user for larger gauge sizes.

Z Height Adjustment Plate for 3-Axis Benchtop Robots

This plate allows you attach the mounting rails above or below the mounting bracket on the robot.

Item #	98357	Z height adjustment plate
--------	-------	---------------------------

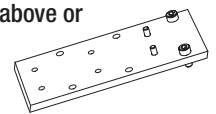

Mounting Rails for 3-Axis Benchtop Robots and Dispense Stations

A mounting rail is required when using Loctite® brand mounting hardware for all 3-axis Benchtop Robots and Dispense Stations.

Item #	98328	3 3/4 in. bar with two cap screws
	98329	8 3/4 in. bar with two cap screws
	98330	12 in. bar with two cap screws

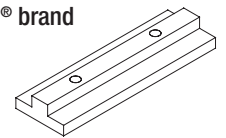

Mounting Plate for 3-Axis SCARA Robots

A mounting plate is required when using Loctite® brand mounting hardware for all 3-axis SCARA Robots (except when using a complete mounting kit).

Item #	98337	Mounting plate for SCARA robot
--------	-------	--------------------------------

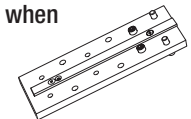

Workbenches

- Strong and sturdy workbenches
- Accommodate all Loctite® brand robots

Item #	989783	200 Series Workbench	36" W x 24" D x 36" H
	989784	300 Series Workbench	42" W x 30" D x 36" H
	989785	400/500 Series Workbench	48" W x 36" D x 36" H
	989860	SCARA Series Workbench	48" W x 48" D x 36" H



Guarding Systems

FOR PLANTS REQUIRING HIGHER SAFETY LEVELS

- Light Curtain or Interlocked Sliding Door* on front
- Sturdy extruded aluminum frame
- Polycarbonate panels on left, right and rear
- Operator control panel mounted on front right
- Direct plug-in to robots

* Interlocked door model for Benchtop units only.

Item #	989787	200 Series Slide Door Guarding System	22" W x 26" D x 27" H
	989763	200 Series Light Curtain Guarding System	22" W x 24" D x 27" H
	989788	300 Series Slide Door Guarding System	30" W x 32" D x 30" H
	989771	300 Series Light Curtain Guarding System	30" W x 30" D x 30" H
	989789	400/500 Series Slide Door Guarding System	32" W x 36" D x 35" H
	989777	400/500 Series Light Curtain Guarding System	32" W x 38" D x 35" H
	989852	SCARA Light Curtain Guarding System	48" W x 48" D x 36" H

Your Source for **EQUIPMENT**
TWO-PART VOLUMETRIC DISPENSING -
LOCTITE® POSI-LINK™
DISPENSE SYSTEM
FOR DUAL CARTRIDGES







When you need high precision dispensing from your prepackaged dual cartridge adhesive, the Loctite® Posi-Link™ Dispense System is the solution. This system offers dispensing accuracy well beyond any pneumatic cartridge dispenser down to 0.001 ml drop size. This system specifically excels at eliminating dispense variability due to continuously changing viscosity (curing) in the mix nozzle. It can easily be integrated into any automated process and provide process feedback to a plant PLC. Select your system based on cartridge size and adhesive ratio requirements. You can choose 50 ml, 200 ml or 400 ml packages for any 1:1, 2:1 or 10:1 ratio product.

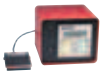

Loctite® Posi-Link™ 10-50 System, Integrated Robotic Solution using a 50 ml dual cartridge, and showing wall-mounted actuator.



[Complete Loctite® Posi-Link™
Dual Cartridge System]

POSI-LINK™ DUAL CARTRIDGE SYSTEM	FOR 50 ML DUAL CARTRIDGES						
	 CONTROLLER	+	 ACTUATOR	+	 NEST		
FOR 200/400 ML DUAL CARTRIDGES							
	 CONTROLLER	+	 ACTUATOR	+	 NEST	+	 PINCH TUBE VALVE

(Each Item Sold Separately.)

Loctite® Posi-Link™ Controller

Provides all operator interface and control signals to actuator.

Item# 98377 Posi-Link™ Controller

FEATURES:

- Dose selection by volume
- Easy programming controller, with storage capacity for 25 user-defined programs, reduces adhesive setup waste
- Smallest footprint on the market to conserve benchtop space
- Automatic cartridge engagement to ensure easy and error-free cartridge changeover
- Adhesive level monitoring with low level visual and digital outputs
- Fault detection with visual and digital outputs for clogged nozzles, loss of pressure and system faults
- In-cycle visual and digital outputs
- Foot switch, finger switch or PLC remote start activation



Loctite® Posi-Link™ Actuators

Provides adhesive dispensing by effecting incremental movements of dual pistons and displacing programmable qualities of adhesive within the cartridge regardless of viscosity changes in the mix nozzle.

Item #	98379	Posi-Link™ 10-50 Actuator	50 ml Cartridges
	98380	Posi-Link™ 200-400 Actuator	200/400 ml Cartridges

* See www.equipment.loctite.com for use with syringes.

FEATURES:

- Flexible orientation in any position.
- Easily fits below an industrial workbench or wall mounts with brackets supplied to conserve benchtop space.
- Lightweight remote dispense head has a “positive link” to actuator via a 7-foot tether, allowing ergonomic hand held dispensing or mounting directly on robotic arms.
- Easily attaches to the dual cartridge nests (sold separately) to accommodate alternate cartridge barrel sizes.
- Mechanically linked dual plungers guarantee proper ratios are achieved.
- Positive shut-off pinch tube available, which directly attaches to the mix nozzle, eliminating dripping.



Loctite® Posi-Link™ 50 ml and 200/400 ml Dual Cartridge Nests

Connects the actuator to the dual cartridge.

Item #	98641	1:1/2:1 – 50 ml Cartridge	Used with Loctite® Posi-Link™ 10-50 Actuator
	98642	10:1 – 50 ml Cartridge	Used with Loctite® Posi-Link™ 10-50 Actuator
	98662	1:1/2:1 – 200 ml Cartridge	Used with Loctite® Posi-Link™ 200-400 Actuator
	98663	1:1/2:1 – 400 ml Cartridge	Used with Loctite® Posi-Link™ 200-400 Actuator
	98664	10:1 – 400 ml Cartridge	Used with Loctite® Posi-Link™ 200-400 Actuator

THEORY OF OPERATION:

A disposable dual cartridge is effectively used as a dual metering piston/cylinder. Because the individual chambers of a dual cartridge are of a known and constant diameter, a given incremental measurement of the dual pistons will displace a known volume of adhesive within each chamber at an exact ratio. This dual cartridge system functions identically to a Loctite® Posi-Link™ Syringe System, except that it has two plungers within the dispense head. These plungers simultaneously act on two chambers within the dual cartridge. You can view a functionality diagram on www.equipment.loctite.com.

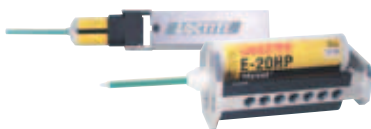

Loctite® Pinch Tube Valve

Item # 97141 Pinch Tube Valve

FEATURES:

- Valve attaches directly to the end of the square mix nozzle
- Provides positive no-drip shut-off, using disposable pinch tube elements

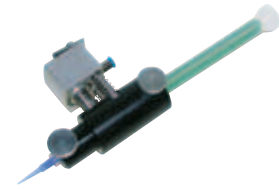

FOR 50 ML DUAL CARTRIDGES – OPTIONAL

Pinch Tube Valve
+
97541 (10 pack) Replacement Tube Inserts
+
98671 Solenoid Valve

FOR 200/400 ML DUAL CARTRIDGES – REQUIRED

Pinch Tube Valve
+
97541 (10 pack) Replacement Tube Inserts
(98671 Solenoid Valve Included with Loctite® Posi-Link™ 200-400 Actuator)



TECHNICAL SPECIFICATIONS	PRODUCT		
	LOCTITE® POSI-LINK™ CONTROLLER ITEM # 98377	LOCTITE® POSI-LINK™ 10-50 ACTUATOR ITEM # 98379	LOCTITE® POSI-LINK™ 200-400 ACTUATOR ITEM # 98380
POWER SOURCE	9 ft. Communication Cable	100/240 VAC; 47/60 Hz	100/240 VAC; 47/60 Hz
DIMENSIONS	5.375" H x 6" D x 6" W	34" H x 4" D x 5" W	34" H x 4" D x 5" W
TOTAL WEIGHT	2 lbs.	13 lbs.	20 lbs.
DISPENSE HEAD WEIGHT (INCLUDES NEST AND PINCH TUBE VALVE)	N/A	2 lbs.	10 lbs.
AIR SUPPLY	N/A	40 to 100 psi	40 to 100 psi
POSI-LINK™ ELECTRO/HYDRAULIC TETHER	N/A	7 feet	7 feet
MINIMUM ¹ DISPENSE VOLUME	N/A	0.005 ml	0.01 ml
DISPENSE RATE ²	N/A	0.009 – 0.4 ml/second	0.009 – 1.0 ml/second
MAXIMUM CYCLE RATE	N/A	1 cycle per second	1 cycle per second
USED TO DISPENSE	N/A	All Dual 50 ml Cartridge 1:1 / 2:1 / 10:1 ratio adhesives	All Dual 200 or 400 ml Cartridge 1:1 / 2:1 / 10:1 ratio adhesives
PARTS INCLUDED	(1) Loctite® Posi-Link™ Controller (1) Foot Switch	(1) Loctite® Posi-Link™ Actuator (1) 9 ft. Controller/Actuator Signal Cord (1) 110 Power Cord (1) Air Inlet Pressure Regulator Gauge (1) Wall or Table Mounting Bracket (1) Instruction Manual	
ADDITIONAL INFORMATION	For Spare Parts and Accessories, see www.loctite.equipment.com. For Static Mix Nozzles and Accessories, see pages 185 and 186.		

¹ Minimum Dispense Volume is a machine dispense capability. As with all mix nozzle systems, the minimum possible shot with “proper mixing” is dependent on a properly specified combination of adhesive, mix nozzle and dispense rate.

² Maximum Dispense Rate varies based on adhesive viscosity and mix nozzle selection.

Your Source for **EQUIPMENT**
TWO-PART
VOLUMETRIC DISPENSING
– METER MIX SYSTEMS

- Customize your system to meet your application requirements. A wide selection of reservoir systems, hoses, valves and other accessories is available. Visit www.equipment.loctite.com or contact your local Henkel® sales rep for more information.

LOCTITE® PRODUCT	DURAPUMP™ PROGRAMMABLE METER MIX SYSTEM 	DURAPUMP™ PNEUMATIC METER MIX SYSTEM 
MACHINE RATIO CAPABILITIES/ITEM NUMBERS		
FIXED	1041649 – 1:1 1041644 – 2:1 1041639 – 4:1 1041638 – 10:1 1041635 – Custom Ratios (available from 1:1 up to 9.99:1)	1041648 – 1:1 1041643 – 2:1 1041641 – 4:1 1041637 – 10:1
MMA COMPATIBLE	N/A	1041647 – 1:1 1041636 – 10:1 1041620 – Custom Ratios
PERFORMANCE SPECIFICATIONS		
DISPENSE RANGE	0.40 cc to 28 cc	
CYCLE RATE	Up to 20 per minute	
MIX RATIO RANGE BY VOLUME	1:1 to 10.0:1	
MAXIMUM PRODUCT FEED PRESSURE	2000 psi	
WETTED COMPONENT MAKEUP		
ABRASION-RESISTANT PUMPS	Standard	Standard
MILD STEEL PUMPS	Not Required	Not Required
INERT PUMPS	Standard	Standard
DISPENSE VALVES		
MIX MANIFOLD <i>(ACCEPTS MIX NOZZLE DIRECTLY)</i>	Standard	Standard
HANDHELD VALVE WITH TRIGGER PISTOL GRIP	Optional	Optional
HANDHELD VALVE WITH LEVER ACTUATION	N/A	N/A
ADJUSTABLE BOOM MOUNTED VALVE	N/A	N/A
SHOT CONTROL CAPABILITIES		
MANUAL/OPERATOR CONTROLLED SHOT	Standard	Standard
MECHANICALLY ADJUSTED LIMIT SWITCH SHOT CONTROL	N/A	Standard
PRE-PROGRAMMED ELECTRONIC SHOT SIZE CONTROL	Standard	N/A
MULTIPLE PRE-PROGRAMMED SHOT SIZE CONTROL	Standard	N/A
TOUCH SCREEN MACHINE CONTROLS	Standard	N/A
OTHER MACHINE FEATURES		
FEED ACCUMULATORS FOR BULK PACKAGE PRESSURE FEED	Not Required	Not Required
MAINTENANCE TOTALIZER	Standard	N/A
LOW/HIGH LEVEL SENSING CAPABLE	Optional – Low Level Only	N/A
SUPERVISOR MACHINE LOCK-OUT	Standard	N/A
PNEUMATICALLY ADJUSTABLE FLOW CONTROL	Standard	Standard
AUTO-PURGE CAPABLE	Standard	N/A
FOOT SWITCH CONTROLLED	Standard	Standard
TECHNICAL SPECIFICATIONS		
USED TO DISPENSE	Two-Part Epoxies, Two-Part Acrylics, Two-Part Polyurethanes, Two-Part Silicones	Two-Part MMAs, Two-Part Epoxies, Two-Part Acrylics, Two-Part Polyurethanes, Two-Part Silicones
PACKAGE TYPES	Any, excluding Dual Cartridges	Any, excluding Dual Cartridges
ADDITIONAL INFORMATION	Please visit www.equipment.loctite.com for feed system options and accessories (sold separately).	

ITEMS IN RED = Source's PICK or NEW

Your Source for EQUIPMENT CONSUMABLES DISPENSE ACCESSORIES

- Full line of Loctite® brand dispense tips, static mix nozzles and syringe barrel components
- Available in stainless steel, tapered polyethylene and flexible polypropylene tips that all feature a positive locking, helical thread design to ensure the tip will stay intact during application
- Wide variety of static mix nozzles is available for two-part adhesive dispensing needs
- High-quality syringe barrels and components are available for single-component adhesive dispensing needs

[Tapered Dispense Tips]

1 1/4 in. Polyethylene Tapered Tips, Helical Thread and UV Light Block Additive



50 PACK ITEM NO.	1,000 PACK ITEM NO.	HUB COLOR	GAUGE
98385	98386	White	14
98387	98388	Grey	16
98389	98390	Green	18
98391	98392	Pink	20
98393	98394	Blue	22
98658*	98659*	Red	25
98660*	98661*	Clear	27

* New smaller gauge sizes

[High Precision Stainless Steel Dispense Tips]

1/4 in. Stainless Steel Tips Helical Thread



50 PACK ITEM NO.	1,000 PACK ITEM NO.	HUB COLOR	GAUGE
830704	830703	Olive	14
98196	98197	Green	18
98198	98199	Pink	20
98200	98201	Purple	21
98624	98625	Red	25
98626	98627	Clear	27
98628	98629	Lavender	30
98114	98115	Yellow	32

1/2 in. Stainless Steel Tips Helical Thread



50 PACK ITEM NO.	1,000 PACK ITEM NO.	HUB COLOR	GAUGE
98396	98397	Amber	15
98398	98399	Green	18
98400	98401	Pink	20
98424	98425	Purple	21
98402	98403	Blue	22
98611	98612	Orange	23
98404	98405	Red	25
1255059	1255058	Light Grey	27
1256848	1256497	Lavender	30

1 in. Stainless Steel Tips Helical Thread



50 PACK ITEM NO.	1,000 PACK ITEM NO.	HUB COLOR	GAUGE
98216	98217	White	14
98218	98219	Amber	15
98222	98223	Green	18
98224	98225	Pink	20
98226	98227	Purple	21
98228	98229	Blue	22
98230	98231	Orange	23
98232	98233	Red	25
98234	98235	Light Grey	27

1 1/2 in. Stainless Steel Tips Helical Thread



50 PACK ITEM NO.	1,000 PACK ITEM NO.	HUB COLOR	GAUGE
98163	98164	White	14
98165	98166	Amber	15
98167	98168	Green	18
98169	98170	Pink	20
98171	98172	Purple	21
98173	98174	Blue	22
98175	98176	Orange	23
98177	98178	Red	25
98179	98180	Light Grey	27

45° by 1/2 in. Stainless Steel Tips Helical Thread



50 PACK ITEM NO.	1,000 PACK ITEM NO.	HUB COLOR	GAUGE
98236	98237	White	14
98240	98241	Amber	15
98244	98245	Green	18
98248	98249	Pink	20
98252	98253	Purple	21
98256	98257	Blue	22
98260	98261	Orange	23
98264	98265	Red	25
98268	98269	Light Grey	27

90° by 1/2 in. Stainless Steel Tips Helical Thread



50 PACK ITEM NO.	1,000 PACK ITEM NO.	HUB COLOR	GAUGE
98238	98239	White	14
98242	98243	Amber	15
98246	98247	Green	18
98250	98251	Pink	20
98254	98255	Purple	21
98258	98259	Blue	22
98262	98263	Orange	23
98266	98267	Red	25
98270	98271	Light Grey	27

Your Source for **EQUIPMENT**
CONSUMABLES
DISPENSE ACCESSORIES

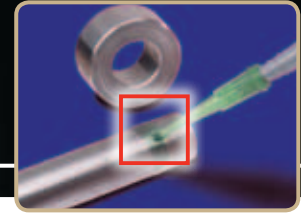
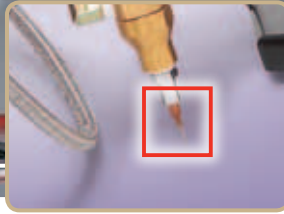

[Flexible Dispense Tips]

1 1/2 in. Polypropylene Tips Helical Thread



50 PACK ITEM NO.	1,000 PACK ITEM NO.	HUB COLOR	GAUGE
97229	98069	Amber	15
97230	98070	Green	18
97231	98071	Pink	20
97232	98082	Red	25

[General-Purpose Dispense Tips]

1/2 in. Stainless Steel Tips



50 PACK ITEM NO.*	1,000 PACK ITEM NO.	HUB COLOR	GAUGE
98208	98209	Olive	14
97225	98065	Amber	15
97226	98066	Green	18
97227	98067	Pink	20
98210	98211	Purple	21
98100	98080	Blue	22
98212	98213	Orange	23
97228	98068	Red	25
98214	98215	Clear	27

* 50 packs in a plastic box

[General-Purpose Tapered Dispense Tips]

1 1/4 in. Polyethylene Tapered Tips



50 PACK ITEM NO.*	1,000 PACK ITEM NO.	HUB COLOR	GAUGE
98272	98273	Tan	14
97221	98061	Grey	16
97222	98062	Green	18
97223	98063	Pink	20
97224	98064	Blue	22

* 50 packs in a plastic box

[Dispense Tips & Accessories]

LOCTITE® PRODUCT	ITEM NUMBER	USED TO DISPENSE
	1146079 (50 pack) 1146078 (1000 pack)	SS, PTFE-Lined, 25 Gauge
	97233	Luer-Lok® Adapter Kit, 20 Luer-Loks® and 5 adapters
	97248 (50 pack) 98499 (1000 pack)	Tip Caps
	97261 (50 pack) 98074 (1000 pack)	High Density Polyethylene, 15 Gauge, White
	97262	2 each of a variety of Helical Threaded 1/2 in. Stainless Steel, Tapered Tip and Polypropylene tips
	272793	Formable Dispense Tip, 21 Gauge (100 pack)
	97511	Tri-Nozzle - Helps eliminate bubbles in anaerobic gasket applications
	98652	Light-blocking shield for dispense tips (10 pack)
	998390	Vari-Drop™ Applicator Brushes (10 pack)

[Needle Variety Kit]



This kit contains five each of an assortment of high precision Stainless Steel Tips in various lengths and gauges. Tapered and Flexible Dispense Tips are also included. All dispense tips have helical thread Luer-Lok® hubs for reliable locking.
Item Number: 98439

[Cartridge Accessories]

LOCTITE® PRODUCT	ITEM NUMBER	USED TO DISPENSE
	98446	Roller Assembly 1 in. wide band
	98448	Roller Assembly 2 in. wide band
	98447	Replacement Roller 1 in. wide (3 pack)
	98449	Replacement Roller 2 in. wide (3 pack)
	98610	3/4 in. wide by 1/4 in. NPT Dispense Nozzle (10 pack)
	1044246	Aero Nozzle for Silicones in aerosol cans (10 pack)
	98128	Cartridge Dispense Tip: 1/4 in. Male Semco Thread (10 pack)
	98371	Cartridge-Needle Adapter: (Female Luer x 1/4 in. Male Semco Thread) Luer-Lok® Adapter for Dispense Needle Attachment (5 pack)
	1147763	Cartridge-Dispense Valve Adapter Assembly Fischbach Thread x 1/4 in. Male NPT
	97215	Cartridge-Syringe Adapter: 1/4 in. Semco Thread x Female Luer, used for downloading
	98181	Cartridge-Tube Fitting Adapter: (1/4 in. FNPT x 1/4 in. Male Semco Thread) used for connecting tube fittings to cartridges. Item Numbers 984832 or 984833 also required and sold separately. (3 pack)
	984832	Tube Fitting: 1/4 in. Male NPT x 1/4 in. Feed Tube (10 pack)
	984833	Tube Fitting: 1/4 in. Male NPT x 3/8 in. Feed Tube (10 pack)
	982644	Cartridge Adapter: SS, (1/4 in. FNPT x 1/4 in. female Fischbach Thread), used for connecting tube fittings
	1045339	Cartridge-Needle Adapter: 1/4 in. NPT Thread x Female Luer - shown with Item Number 982644 for 1/4 in. Fischbach, for needle attachment (5 pack)
	1044247	Cartridge-Syringe Adapter: 1/4 in. MNPT x Female Luer shown with Item Number 982644 for 1/4 in. Fischbach, used for downloading (5 pack)

[Loctite® Brand Syringe Accessories]

















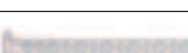
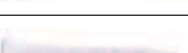

LOCTITE® PRODUCT	ITEM NUMBER	DESCRIPTION	CONTENTS
	98656 98657 97208 97245	3 ml Syringe Air Line Adapter 5 ml Syringe Air Line Adapter 10 ml Syringe Air Line Adapter 30 ml and 55 ml Syringe Air Line Adapter	2 Air Line Adapters – Common to all part numbers (Syringe barrel sold separately.)
	984650	Air Line Filter for Syringe Dispensing to prevent product back-flow	1 Filter Assembly with 2 Hose Crimps
	97216 97294 98416	10 ml Syringe Starter Kit 30 ml Syringe Starter Kit 55 ml Syringe Starter Kit	5 Caps 5 Pistons 4 Clear Barrels 1 Black Barrel 5 Tips 1 Air Line Adapter
	97207 97263	10 ml Clear Syringe Starter Kit 10 ml Black Syringe Barrel Kit for UV Adhesives	20 Barrel Caps, 40 Pistons, 40 Barrels, 40 Barrel Tips
	97244 97264	30 ml Clear Syringe Starter Kit 30 ml Black Syringe Barrel Kit for UV Adhesives	10 Barrel Caps, 20 Pistons, 20 Barrels, 20 Barrel Tips
	98314 98315	55 ml Clear Syringe Starter Kit 55 ml Black Syringe Barrel Kit for UV Adhesives	5 Barrel Caps, 10 Pistons, 10 Barrels, 10 Barrel Tips
		Clear or Black, 3 ml, 5 ml, 10 ml, 30 ml and 55 ml Piston/Syringe Combination Packages	
	98479	3 ml Syringe Barrel and Piston, Clear	50 Pack
	98481	3 ml Syringe Barrel and Piston, Black	50 Pack
	98483	5 ml Syringe Barrel and Piston, Clear	50 Pack
	98485	5 ml Syringe Barrel and Piston, Black	50 Pack
	98487	10 ml Syringe Barrel and Piston, Clear	50 Pack
	98489	10 ml Syringe Barrel and Piston, Black	50 Pack
	98491	30 ml Syringe Barrel and Piston, Clear	50 Pack
	98493	30 ml Syringe Barrel and Piston, Black	50 Pack
	98496	55 ml Syringe Barrel and Piston, Clear	50 Pack
98497	55 ml Syringe Barrel and Piston, Black	50 Pack	
	Various	Dark Amber Syringe and Piston options	Available upon request. Please contact your Loctite® Sales Representative or contact us at www.equipment.loctite.com.
		Loctite® Manual Syringe Kits	Each Kit contains Plunger, Stopper and Clear Barrel, unassembled.
	1176432	3 ml Clear Manual Syringe Kit	1,000 Pack
	1176431	6 ml Clear Manual Syringe Kit	1,000 Pack
	1180633 1180634	10 ml Clear Manual Syringe Kit 35 ml Clear Manual Syringe Kit	1,000 Pack 500 Pack
	98501	Loctite® Applicator Holder for 10 ml, 30 ml and 55 ml Syringe Barrels (Red)	1 Holder (Syringe Barrel and Air Line Adapter sold separately.)
	97215	Cartridge-Syringe Adapter: 1/4 in. Semco Thread x Female Luer, used for downloading.	

ITEMS IN RED = Source's PICK or NEW













Your Source for **EQUIPMENT**
CONSUMABLES
DISPENSE ACCESSORIES

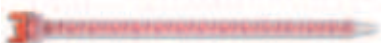

[Loctite® Brand Static Mix Nozzles & Accessories]

LOCTITE® PRODUCT	ITEM NUMBER	PACKAGE QUANTITY	DESCRIPTION
MIX NOZZLES FOR 50 ML DUAL CARTRIDGES			
	98444 1405182	10 5,000	50 ml Square Mix Nozzle, Luer/Stepped Combo Tip, 3.25 in. Overall Length, 5.3 mm ² , 16 elements; 1:1, 2:1 mix ratios.
	98473 98632	10 1,000	50 ml Square Mix Nozzle, Luer/Stepped Combo Tip, 4.5 in. Overall Length, 5.3 mm ² , 24 elements; 1:1, 2:1, 4:1 mix ratios.
	98622 983509	10 2,000	50 ml Mix Nozzle, 5.9 in. Overall Length, 0.250 in. ID, Slip-Luer, 20 elements; 1:1, 2:1 and 4:1 ratios. 
	98623 98364	10 2,000	50 ml Mix Nozzle, 5.9 in. Overall Length, 0.250 in. ID, Stepped Tip-Luer, 20 elements; 1:1, 2:1 and 4:1 ratios. 
	98454	10	50 ml Mix Nozzle, Luer Tip, 6.0 in. Overall Length, 6.35 mm diameter, 21 elements; 1:1, 2:1, 4:1 mix ratios.
	98455 1116241	10 2,500	50 ml Mix Nozzle, Stepped Tip, 6.0 in. Overall Length, 6.35 mm diameter, 21 elements; 1:1, 2:1, 4:1 mix ratios.
	1034575	10	50 ml-S Mix Nozzle, Stepped Tip, 6.2 in. Overall Length, 6.5 mm ID, 20 elements; 10:1-S cartridges only
	1145743 1143355	10 2,000	50 ml Mix Nozzle with Integral Needle Adapter, 5.9 in. Overall Length, .25 in. 6.35 mm ID, 20 elements; 1:1, 2:1 ratios
	1259190	10	50 ml Round Mix Nozzle, Luer Tip, 4.7 mm ID, 3.3 inch long, 16 elements, 1:1, 2:1 mix ratios
MIX NOZZLES FOR 200 ML & 400 ML DUAL CARTRIDGES			
	98373 98374	10 1,000	200/400 ml Square Mix Nozzle, Luer/Stepped Combo Tip, 5.0 in. Overall Length, 5.3 mm ² , 24 elements; 1:1, 2:1, 4:1 mix ratios.
	98474 98653	10 1,000	200/400 ml Square Mix Nozzle, Stepped Tip, 5.1 in. Overall Length, 7.5 mm ² , 24 elements; 1:1, 2:1 mix ratios.
	98667 98668	10 500	200/400 ml Square Mix Nozzle, Threaded Bell End 114.5 mm ² , 187 mm Overall Length, 24 elements; 1:1, 2:1 ratios.
	98456 1053262	10 2,000	200/400 ml Mix Nozzle, Stepped Tip, 7.3 in. Overall Length, 6.3 mm diameter, 24 elements; 1:1, 2:1 mix ratios.
	98457 98464	10 1,500	200/400 ml Mix Nozzle, Stepped Tip, 8.8 in. Overall Length, 8 mm diameter, 24 elements; 1:1, 2:1 mix ratios.
	930705	1,000	200/400 ml Mix Nozzle, Stepped Tip, 10.9 in. Overall Length, 10 mm diameter, 24 elements; 1:1, 2:1 mix ratios.
	989516	50	200/400 ml Mix Nozzle, 7.4 in. Overall Length, 0.188 in. ID, Stepped Tip, 32 elements; 1:1, 2:1 and 4:1 ratios.
	989518	10	200/400 ml Mix Nozzle, 9.0 in. Overall Length, 0.188 in. ID, Stepped Tip, 48 elements; 1:1, 2:1 and 4:1 ratios.
	918088	10	200/400 ml Mix Nozzle, Luer Tip, 9.5 in. Overall Length, 0.25 in. ID, Slip Luer, 32 elements; 1:1 and 2:1 ratios.
	1032026 1032028	10 1,200	200/400 ml Mix Nozzle, 11.3 in. Overall Length, 8 mm diameter, 32 elements; 1:1, 2:1 mix ratios.

[Loctite® Brand Static Mix Nozzles & Accessories]

LOCTITE® PRODUCT	ITEM NUMBER	PACKAGE QUANTITY	DESCRIPTION
MIX NOZZLES FOR 200 ML & 400 ML DUAL CARTRIDGES (CONTINUED)			
	98672 98430	10 500	200/400 ml Mix Nozzle, Stepped Tip, 14.2 in. Overall Length, 9.3 mm diameter, 40 elements; 1:1, 2:1 mix ratios.
	1145744	10	200/400 ml Mix Nozzle, 7.5 in. Overall Length, 10.6 mm ² , V-Notch Tip; 1:1, 2:1 ratios.
	98469 98367	10 1,000	200/400 ml Snap Tip Mix Nozzle, 9.3 in. Overall Length, 9.3 mm diameter, 24 elements; 1:1, 2:1 mix ratios. For use with Ribbon Tips.
	1228790	1,000	200/400 Stepped Tip Mix Nozzle, 8.5 in. Overall Length, 13 mm ID, 18 elements; 1:1, 2:1 mix ratios
MIX NOZZLES FOR 200 ML & 400-F ML DUAL CARTRIDGES			
	1084255 1076341	10 1,200	200/400 ml 4:1 Cartridge Mix Nozzle, 9.2 in. Overall Length, 8 mm ID, Stepped Tip, 24 elements; and 490 ml 10:1 ratios.
	1084092 1084093	10 900	200/400-F Cartridge Mix Nozzle, 11.2 in. Overall Length, 10 mm ID, Stepped Tip, 24 elements; 4:1, 10:1 ratios.
MIX NOZZLES FOR 300 ML SINGLE AXIS DUAL CARTRIDGES			
	1100962	3	300 ml Single-Axis Cartridge Mix Nozzle, 10 in. Overall Length, 11.2 mm ² , Threaded Tip; 20 elements.
	1100963	3	300 ml Single Axis Cartridge Mix Nozzle, 15.3 in. Overall Length, 14.3 mm ² , Threaded Tip; 19 elements.
MIX NOZZLES FOR 490 ML DUAL CARTRIDGES			
	98460	10	490 ml Mix Nozzle, Stepped Tip, Keyed, 9.1 in. Overall Length, 8 mm diameter, 24 elements; 4:1, 10:1 ratios.
	98461 98409	10 1,000	490 ml Mix Nozzle, Stepped Tip, Keyed, 10.8 in. Overall Length, 10 mm diameter, 24 elements; 4:1, 10:1 mix ratios.
	1130330 1130329	10 1,800	490 ml Stepped Tip Mix Nozzle, 7.2 in. Overall Length, 8 mm ID, 18 elements; 10:1 mix ratio
SPRAYABLE CERAMIC MIX NOZZLES			
	1248606	10	200/400 Spray Tip Mix Nozzle, .25 in. ID, 24 elements for use with sprayable ceramic materials
MIX NOZZLES ADAPTERS			
	98458 970655	10 2,000	Luer-Lok® Adapter for 6.3 mm and 8 mm Stepped Tip Mix Nozzles, allows for Dispense Needle Attachment (10 pack). Mix Nozzles and Dispense Needles sold separately.

ITEMS IN RED = *Source's* PICK or NEW

Your Source for
LOCTITE® PRODUCTS
FOR DESIGN, ASSEMBLY,
MANUFACTURING & MAINTENANCE
AGENCY LISTINGS

LOCTITE® PRODUCTS ARE DESIGNED TO MEET THE SPECIFICATIONS AND TESTING STANDARDS OF A VARIETY OF AGENCIES. THE FOLLOWING IS A LIST OF PRODUCTS AND STANDARDS TO WHICH SUCH PRODUCTS MAY CONFORM. BECAUSE SUCH STANDARDS CHANGE OR MAY BE MODIFIED, NO WARRANTY IS GIVEN REGARDING SUCH COMPLIANCE. THE INFORMATION PROVIDED BELOW MAY BE USED, HOWEVER, AS A QUICK REFERENCE TOOL TO AID IN DESIGN OR APPLICATION. FOR UP-TO-THE-MINUTE INFORMATION ON AGENCY APPROVALS, OR TO INQUIRE ABOUT ADDITIONAL AGENCY APPROVALS, PLEASE CONTACT HENKEL TECHNICAL SUPPORT AT 1-800-LOCTITE (562-8483) WITH ANY INQUIRIES. LAST UPDATED DECEMBER 14, 2010.

NSF® International

NON-FOOD COMPOUND

- Loctite® 222MS™ Threadlocker, Low Strength/Small Screw
- Loctite® 242™ Threadlocker, Medium Strength
- Loctite® 262™ Threadlocker, Medium to High Strength
- Loctite® 290™ Threadlocker, Wicking Grade
- Loctite® 587™ Blue, High Performance RTV Silicone Gasket Maker
- Loctite® 5900™ Flange Sealant, Heavy Body RTV Silicone
- Loctite® 7649™ Primer N™
- Loctite® Food Grade Anti-Seize
- Loctite® Food Grade Grease
- Loctite® ODC-Free Cleaner & Degreaser
- Loctite® ViperLube® Clear High Performance Synthetic Grease
- Loctite® ViperLube® High Performance Synthetic Grease
- Loctite® ViperLube® High Performance Synthetic Grease (aerosol)

STANDARD 51

- Superflex® RTV, Silicone Adhesive Sealants Clear

STANDARD 61

- Loctite® 242™ Threadlocker, Medium Strength
- Loctite® 243™ Blue Threadlocker
- Loctite® 290™ Threadlocker, Wicking Grade
- Loctite® 480™ Prism® Instant Adhesive, Black/Toughened
- Loctite® 518™ Gasket Eliminator® Flange Sealant
- Loctite® QuickStix® 561™ PST® Pipe Sealant
- Loctite® 565™ PST® Thread Sealant, Controlled Strength
- Loctite® 567™ PST® Thread Sealant, High Temperature
- Loctite® 680™ Retaining Compound, Slip Fit/High Strength
- Loctite® 7649™ Primer N™
- Loctite® Fixmaster® Metal Magic Steel
- Loctite® Nordbak® Brushable Ceramic Grey

American Bureau of Shipping (ABS)

- Loctite® 242™ Threadlocker, Medium Strength
- Loctite® 262™ Threadlocker, Medium to High Strength
- Loctite® 404™ Quick Set™ Instant Adhesive, General-Purpose
- Loctite® 454™ Prism® Instant Adhesive, Surface Insensitive Gel
- Loctite® 495™ Super Bonder® Instant Adhesive
- Loctite® 545™ Thread Sealant, Hydraulic/Pneumatic Fittings
- Loctite® 567™ PST® Thread Sealant, High Temperature
- Loctite® 587™ Blue, High Performance RTV Silicone Gasket Maker
- Loctite® 598™ Black, High Performance RTV Silicone Gasket Maker
- Loctite® 620™ Retaining Compound, Slip Fit/High Temperature
- Loctite® 680™ Retaining Compound, Slip Fit/High Strength
- Loctite® Extend® Rust Treatment
- Loctite® Fixmaster® Aluminum Liquid
- Loctite® Fixmaster® Aluminum Putty
- Loctite® Fixmaster® Poxypak™, Fast Cure Epoxy
- Loctite® Fixmaster® Fast Set Steel Putty
- Loctite® Fixmaster® Flex 80™ Putty
- Loctite® Fixmaster® Marine Chocking
- Loctite® Fixmaster® Stainless Steel Putty
- Loctite® Fixmaster® Steel Liquid
- Loctite® Fixmaster® Steel Putty
- Loctite® Fixmaster® Wear-Resistant Putty
- Loctite® Fixmaster® Wet Surface Repair Putty
- Loctite® Marine Grade Anti-Seize
- Loctite® Nickel Anti-Seize
- Loctite® Nordbak® Brushable Ceramic, Grey
- Loctite® Nordbak® Pneu-Wear
- Loctite® Silver Grade Anti-Seize

Navy Environmental Health Center (NEHC)

- Loctite® Fixmaster® Aluminum Putty
- Loctite® Fixmaster® Fast Set Steel Epoxy
- Loctite® Fixmaster® Stainless Steel Putty
- Loctite® Fixmaster® Steel Putty
- Loctite® Fixmaster® Superior Metal
- Loctite® Fixmaster® Wear-Resistant Putty
- Loctite® Fixmaster® Wet Surface Repair Putty
- Loctite® Nordbak® Pneu-Wear
- Loctite® Nordbak® Wearing Compound

Military Specifications (Mil Spec)

- Loctite® 220™ Threadlocker, Wicking Grade/Low Strength
- Loctite® 222MS™ Threadlocker, Low Strength/Small Screw
- Loctite® 242™ Threadlocker, Medium Strength
- Loctite® 262™ Threadlocker, Medium to High Strength
- Loctite® 271™ Threadlocker, High Strength
- Loctite® 277™ Threadlocker, High Strength/Large Threads
- Loctite® 290™ Threadlocker, Wicking Grade
- Loctite® 571™ Thread Sealant, Pipe Sealant HVV
- Loctite® 609™ Retaining Compound, Press Fit/General-Purpose
- Loctite® 635™ Retaining Compound, Slip Fit/High Strength/Slow Cure
- Loctite® 640™ Retaining Compound, Press Fit/Medium Strength/High Temperature
- Loctite® 675™ Retaining Compound, Press Fit/Medium Strength
- Loctite® 712™ Tak Pak® Accelerator
- Loctite® 5040™ RTV Silicone
- Loctite® 5045™ Flange Sealant
- Loctite® 7452™ Tak Pak® Accelerator
- Loctite® 7471™ Primer T™
- Loctite® 7649™ Primer N™

Military Specifications (Commercial Item Description)

- Loctite® 404™ Quick Set™ Instant Adhesive, General-Purpose
- Loctite® 406™ Prism® Instant Adhesive, Surface Insensitive
- Loctite® 414™ Super Bonder® Instant Adhesive
- Loctite® 415™ Super Bonder® Instant Adhesive
- Loctite® 416™ Super Bonder® Instant Adhesive
- Loctite® 420™ Super Bonder® Instant Adhesive
- Loctite® 422™ Super Bonder® Instant Adhesive
- Loctite® 430™ Super Bonder® Instant Adhesive
- Loctite® 444™ Tak Pak® Instant Adhesive
- Loctite® 493™ Super Bonder® Instant Adhesive
- Loctite® 495™ Super Bonder® Instant Adhesive
- Loctite® 496™ Super Bonder® Instant Adhesive

Federal Food Drug & Cosmetic Act

21 C.F.R. § 175.300

- Loctite® 2046™ Threadlocker

ISO® 10993 Compliant

- Loctite® M-11FL™ Hysol® Medical Device Urethane Adhesive
- Loctite® M-21HP™ Hysol® Medical Device Epoxy Adhesive
- Loctite® M-31CL™ Hysol® Medical Device Epoxy Adhesive
- Loctite® M-121HP™ Hysol® Medical Device Epoxy Adhesive
- Loctite® 435™ Prism® Instant Adhesive
- Loctite® 713™ Prism® Medical Device Accelerator
- Loctite® 3201™ Light Cure Adhesive, Polycarbonate/Thermoplastics
- Loctite® 3211™ Light Cure Adhesive, Polycarbonate/Thermoplastics
- Loctite® 3301™ Light Cure Adhesive, Plastic/Metal
- Loctite® 3311™ Light Cure Adhesive, Plastic/Metal
- Loctite® 3321™ Light Cure Adhesive, Plastic/Metal
- Loctite® 3341™ Light Cure Adhesive, Plasticized Substrates
- Loctite® 3345™ Light Cure Adhesive, Glass/Metal
- Loctite® 3381™ Light Cure Adhesive, Flexible/Plastics
- Loctite® 3552™ Indigo® Light Cure Adhesive
- Loctite® 3553™ Indigo® Light Cure Adhesive
- Loctite® 3911™ Light Cure Adhesive
- Loctite® 3912™ Light Cure Adhesive
- Loctite® 3913™ Light Cure Adhesive
- Loctite® 3921™ Light Cure Adhesive, Plastic/Metal
- Loctite® 3922™ Light Cure Adhesive, Plastic/Metal
- Loctite® 3924™ Light Cure Adhesive, Plastic/Metal
- Loctite® 3926™ Light Cure Adhesive, Plastic/Metal
- Loctite® 3933™ Light Cure Adhesive
- Loctite® 3936™ Light Cure Adhesive
- Loctite® 3941™ Light Cure Adhesive, High Performance/Various Substrates
- Loctite® 3942™ Light Cure Adhesive, High Performance/Various Substrates
- Loctite® 3943™ Light Cure Adhesive, High Performance/Various Substrates
- Loctite® 3944™ Light Cure Adhesive
- Loctite® 3971™ Light Cure Adhesive, Plasticized Substrates
- Loctite® 3972™ Light Cure Adhesive, Plasticized Substrates
- Loctite® 3981™ Hysol® Epoxy Adhesive, High Performance/Various Substrates
- Loctite® 3982™ Hysol® Epoxy Adhesive, High Performance/Various Substrates
- Loctite® 3984™ Hysol® Epoxy Adhesive, High Performance/Various Substrates
- Loctite® 4011™ Prism® Medical Device Instant Adhesive
- Loctite® 4013™ Prism® Medical Device Instant Adhesive
- Loctite® 4014™ Prism® Medical Device Instant Adhesive
- Loctite® 4031™ Prism® Medical Device Instant Adhesive
- Loctite® 4061™ Prism® Medical Device Instant Adhesive
- Loctite® 4081™ Prism® Medical Device Instant Adhesive
- Loctite® 4161™ Super Bonder® Medical Device Instant Adhesive
- Loctite® 4206™ Prism® Medical Device Instant Adhesive
- Loctite® 4304™ Flashcure® Light Cure Adhesive
- Loctite® 4305™ Flashcure® Light Cure Adhesive
- Loctite® 4306™ Flashcure® Light Cure Adhesive, Instant
- Loctite® 4307™ Flashcure® Light Cure Adhesive, Instant
- Loctite® 4541™ Prism® Medical Device Instant Adhesive
- Loctite® 4601™ Prism® Medical Device Instant Adhesive
- Loctite® 4851™ Prism® Medical Device Instant Adhesive, Flexible
- Loctite® 4861™ Prism® Medical Device Instant Adhesive, Flexible
- Loctite® 4981™ Super Bonder® Medical Device Instant Adhesive
- Loctite® 5248™ Nuva-Sil® Medical Device Silicone Adhesive
- Loctite® 7451™ Prism® Medical Device Accelerator
- Loctite® 7701™ Prism® Medical Device Adhesive Primer

UL Classified/Listed for U.S.

- Loctite® 271™ Threadlocker, High Strength
- Loctite® 515™ Gasket Eliminator® Flange Sealant
- Loctite® QuickStix® 561™ PST® Pipe Sealant
- Loctite® 565™ PST® Thread Sealant, Controlled Strength
- Loctite® 567™ PST® Thread Sealant, High Temperature
- Loctite® 587™ Blue, High Performance RTV Silicone Gasket Maker
- Loctite® 5091™ Nuva-Sil® Silicone Potting Compound, High Adhesion
- Loctite® 5600™ Silicone Sealant
- Loctite® 7809FR™ Hysol® Hot Melt Adhesive, Polyamide
- Loctite® Superflex® RTV, Silicone Adhesive Sealants Clear
- Loctite® 5606™ Silicone
- Loctite® 3364™ Urethane
- Loctite® 5611F™ Silicone
- Loctite® 5611S™ Silicone
- Loctite® E-40EXP™ Epoxy
- Loctite® 5604™ Silicone

ULC Classified for Canada

- Loctite® 565™ PST® Thread Sealant, Controlled Strength
- Loctite® 567™ PST® Thread Sealant, High Temperature

CSA® International

- Loctite® 565™ PST® Thread Sealant, Controlled Strength

Lloyd's Register Certification

- Loctite® Fixmaster® Aluminum Liquid
- Loctite® Fixmaster® Aluminum Putty
- Loctite® Fixmaster® Fast Set Steel Epoxy
- Loctite® Fixmaster® Marine Chocking – Orange
- Loctite® Fixmaster® Marine Chocking – Green
- Loctite® Fixmaster® Steel Liquid
- Loctite® Fixmaster® Steel Putty
- Loctite® Fixmaster® Stainless Steel Putty
- Loctite® Fixmaster® Superior Metal
- Loctite® Fixmaster® Wear-Resistant Putty
- Loctite® Nordbak® Pneu-Wear
- Loctite® Nordbak® Brushable Ceramic – Grey

[Evaluated and Accepted by the Canadian Food Inspection Agency]

Canadian Food Inspection Agency (CFIA)

- Loctite® 220™ Threadlocker, Wicking Grade/Low Strength
- Loctite® 222MS™ Threadlocker, Low Strength/Small Screw
- Loctite® 242® Threadlocker, Medium Strength
- Loctite® QuickStix® 248™ Threadlocker, Medium Strength/Removable
- Loctite® 262™ Threadlocker, Medium to High Strength
- Loctite® 266™ Threadlocker, High Strength/High Temperature
- Loctite® QuickStix® 268™ Threadlocker, High Strength
- Loctite® 271™ Threadlocker, High Strength
- Loctite® 272™ Threadlocker, High Strength/High Temperature
- Loctite® 2760™ Threadlocker, Primerless/High Strength
- Loctite® 290™ Threadlocker, Wicking Grade
- Loctite® 380™ Black Max® Instant Adhesive, Toughened
- Loctite® 401™ Prism® Instant Adhesive, Surface Insensitive
- Loctite® 404™ Quick Set™ Instant Adhesive, General-Purpose
- Loctite® 410™ Prism® Instant Adhesive, Black/Toughened
- Loctite® 414™ Super Bonder® Instant Adhesive
- Loctite® 416™ Super Bonder® Instant Adhesive
- Loctite® 422™ Super Bonder® Instant Adhesive
- Loctite® 454™ Prism® Instant Adhesive, Surface Insensitive Gel
- Loctite® 518™ Gasket Eliminator® Flange Sealant
- Loctite® 545™ Thread Sealant, Pneumatic/Hydraulic
- Loctite® QuickStix® 548™ Gasket Eliminator® Flange Sealant
- Loctite® 554™ Thread Sealant, Refrigerant Sealant
- Loctite® QuickStix® 561™ PST® Pipe Sealant
- Loctite® 564™ Thread Sealant, General-Purpose
- Loctite® 565™ PST® Thread Sealant, Controlled Strength
- Loctite® 567™ PST® Thread Sealant, High Temperature
- Loctite® 569™ Thread Sealant, Hydraulic Sealant
- Loctite® 5699™ Grey, High Performance RTV Silicone Gasket Maker
- Loctite® 587™ Blue, High Performance RTV Silicone Gasket Maker
- Loctite® 5900™ Flange Sealant, Heavy Body RTV Silicone
- Loctite® 5905™ Flange Sealant, RTV Silicone
- Loctite® 5910™ Flange Sealant, RTV Silicone
- Loctite® 592™ PST® Thread Sealant, Slow Cure
- Loctite® 5920™ Copper, High Performance RTV Silicone Gasket Maker
- Loctite® Superflex® Silicone Adhesive Sealant, Black
- Loctite® Superflex® Silicone Adhesive Sealant, White
- Loctite® Superflex® Silicone Adhesive Sealant, Clear
- Loctite® Superflex® Red High Temp RTV, Silicone Adhesive Sealant
- Loctite® 598™ Black, High Performance RTV Silicone Gasket Maker
- Loctite® 609™ Retaining Compound, Press Fit/General-Purpose
- Loctite® 620™ Retaining Compound, Slip Fit/High Temperature

- Loctite® 638™ Retaining Compound, Slip Fit/Maximum Strength
- Loctite® 641™ Retaining Compound, Press & Slip Fit/Controlled Strength
- Loctite® 660™ Quick Metal® Retaining Compound, Press Fit Repair
- Loctite® 680™ Retaining Compound, Slip Fit/High Strength
- Loctite® 712™ Tak Pak® Accelerator
- Loctite® 7649™ Primer N™
- Loctite® 770™ Prism® Primer
- Loctite® Aviation Gasket Sealant
- Loctite® Belt Dressing & Conditioner
- Loctite® Big Foot® Acrylic Pedestrian Grade
- Loctite® Big Foot® Heavy Duty Pedestrian Grade
- Loctite® Big Foot® Low Profile Pedestrian Grade
- Loctite® Big Foot® Vehicular Grade
- Loctite® Big Foot® Zero V.O.C.
- Loctite® QuickStix® C5-A® Copper Anti-Seize
- Loctite® Chisel® Gasket Remover
- Loctite® Cold Galvanizing Compound
- Loctite® Color Guard®, Black
- Loctite® Color Guard®, Blue
- Loctite® Color Guard®, Red
- Loctite® Color Guard®, Yellow
- Loctite® Contact Adhesive, Yellow
- Loctite® Contact Adhesive, Black
- Loctite® Extend® Rust Treatment
- Loctite® Fixmaster® Aluminum Liquid
- Loctite® Fixmaster® Aluminum Putty
- Loctite® Nordbak® Brushable Ceramic, Grey
- Loctite® Nordbak® Brushable Ceramic, Red
- Loctite® Nordbak® Brushable Ceramic, White
- Loctite® Nordbak® Chemical Resistant Coating
- Loctite® Fixmaster® Deep Pour Grout
- Loctite® Fixmaster® Fast Cure Epoxy, Mixer Cups
- Loctite® Fixmaster® Poxy Pak™
- Loctite® Fixmaster® Fast Set Grout
- Loctite® Fixmaster® Fast Set Steel Epoxy
- Loctite® Fixmaster® Fast Set Steel Putty
- Loctite® Fixmaster® Floor Fill
- Loctite® Fixmaster® General-Purpose Epoxy, Mixer Cups
- Loctite® Fixmaster® High Performance Epoxy
- Loctite® Fixmaster® High Performance Quartz
- Loctite® Fixmaster® Magna-Crete
- Loctite® Fixmaster® Marine Chocking (Green)
- Loctite® Nordbak® Fast Cure Pneu-Wear
- Loctite® Nordbak® Pneu-Wear
- Loctite® Fixmaster® Stainless Steel Putty
- Loctite® Fixmaster® Steel Liquid
- Loctite® Fixmaster® Steel Putty
- Loctite® Fixmaster® Superior Metal

- Loctite® Fixmaster® Underwater Repair Epoxy
- Loctite® Fixmaster® Wear-Resistant Putty
- Loctite® Food Grade Anti-Seize
- Loctite® Food Grade Grease
- Loctite® Silicone Lubricant
- Loctite® Form-A-Thread® Stripped Thread Repair
- Loctite® Gasket Sealant 1
- Loctite® High Temperature Gasket Maker
- Loctite® H.V.A.C. Blue Pipe Joint Compound
- Loctite® 0151™ Hysol® Epoxy Adhesive, Ultra Clear
- Loctite® 608™ Hysol® Epoxy Adhesive, High Strength
- Loctite® 615™ Hysol® Epoxy Adhesive, Sandable
- Loctite® 907™ Hysol® Epoxy Adhesive
- Loctite® 9340™ Epoxy Adhesive
- Loctite® E-00CL™ Hysol® Epoxy Adhesive, Low Odor
- Loctite® E-00NS™ Hysol® Epoxy Adhesive, Non-Sag
- Loctite® E-05CL™ Hysol® Epoxy Adhesive, Toughened
- Loctite® E-120HP™ Hysol® Epoxy Adhesive, Ultra Strength
- Loctite® E-20HP™ Hysol® Epoxy Adhesive, Fast Setting
- Loctite® E-20NS™ Hysol® Epoxy Adhesive, Metal Bonder
- Loctite® E-30CL™ Hysol® Epoxy Adhesive, Glass Bonder
- Loctite® E-40FL™ Hysol® Epoxy Adhesive, Flexible
- Loctite® E-60HP™ Hysol® Epoxy Adhesive, Toughened
- Loctite® E-60NC™ Hysol® Epoxy Adhesive, Electrically Noncorrosive
- Loctite® E-90FL™ Hysol® Epoxy Adhesive, Flexible
- Loctite® U-05FL™ Hysol® Urethane Adhesive, High Strength
- Loctite® U-10FL™ Hysol® Urethane Adhesive
- Loctite® Instant Gasket
- Loctite® Maintain® Lubricant Penetrant
- Loctite® Maxi-Coat™, Aerosol
- Loctite® Maxi-Coat™, Liquid
- Loctite® Natural Blue® Biodegradable Cleaner & Degreaser
- Loctite® Natural Blue® Biodegradable Cleaner & Degreaser, Fragrance-Free
- Loctite® No More Leaks™ Plastic Pipe Sealant
- Loctite® O-Ring Making Kit
- Loctite® Pipe Repair Kit
- Loctite® QuickStix® Silver Grade Anti-Seize
- Loctite® Silver Grade Anti-Seize, Aerosol
- Loctite® Solvo-Rust® Super Penetrating Oil
- Loctite® Thread Sealant With PTFE
- Loctite® Urethane Sealant
- Loctite® ViperLube® Clear High Performance Synthetic Grease
- Loctite® ViperLube® High Performance Synthetic Grease
- Loctite® ViperLube® High Performance Synthetic Grease, Aerosol

Your Source for
LOCTITE® PRODUCTS
 FOR DESIGN, ASSEMBLY,
 MANUFACTURING & MAINTENANCE
FAQs



[Durometer Hardness]

Durometer hardness is a property presented on Technical Data Sheets that shows how hard the resin is in the cured state. A durometer gauge is the actual measuring device consisting of a small drill or blunt indenter point under pressure. Different measurement scales are used for different materials depending on how soft or hard the material. The following chart compares three (3) different graduated measurement scales and relates hardness values to some common objects as well as Loctite® brand products.

SHORE A	SHORE D	ROCKWELL M	REFERENCE OBJECT	LOCTITE® PRODUCT
30	–	–	Art Gum Eraser	5140™
40	–	–	Pink Pearl Eraser	5900®
50	15	–	Rubber Stamp	–
60	–	–	Pencil Eraser	5699™
70	30	–	Rubber Heel	–
80	–	–	Rubber Sole	–
90	45	–	Typewriter Roller	366™
100	55	–	Pipe Stem	3106™
–	74	0	Textbook Cover	334™
–	78	32	Douglas Fir Plywood	–
–	82	63	–	E-60HP™
–	86	95	Hardwood Desktop	–
–	90	125	Glass or Formica	–

The higher the number within each scale, the harder the material. Shore readings are typically used for plastics. Shore A is for softer materials; Shore D is for harder materials. Rockwell M readings are typically used for metals.

[Mathematical Conversions]

The following are some common conversions that might be helpful when using Loctite® products:

- 1 milliliter (ml) = 1 cubic centimeter (cc)
- 1,000 ml = 1 liter
- 29.5 ml = 1 fl. oz.
- 3.78 liters = 1 gallon
- 473 ml = 1 pint
- 454 grams (g) = 1 lb.
- 947 ml = 1 quart
- 1 kilogram (k) = 2.2 lbs.
- *Weight to Volume:* grams ÷ specific gravity = cc (ml)
- *Volume to Weight:* cc (ml) x specific gravity = grams
- *Density* = specific gravity x 0.99823
- *Centipoises (cP)* = centistokes x density (at a given temperature)
- *Temperature:* degrees F - 32 x 0.556 = degrees C
degrees C x 1.8 + 32 = degrees F
- Square Inches to Square Feet: ÷ by 144
- Square Feet to Square Inches: x by 144
- In./lbs. ÷ 12 = ft./lbs.
- Ft./lbs. x 12 = in./lbs.
- 16 in. oz. = 1 in. lb.
- 192 in. oz. = 1 ft. lb.

[Area Coverage]

Flat Parts:

Length x Width x Bondline Thickness x 16.4 = cc/ml requirement per part

Non-threaded Cylindrical Parts:

Diameter x Engagement Length x Bondline Thickness (on radius/per side)
 x 3.14 x 16.4 = cc/ml requirement per part

Potting/Encapsulating Applications:

Area (3.14 x R²) x Potting Depth x 16.4 = cc/ml requirement per part

For no induced gap, make the bondline thickness figure 0.001 in.; 16.4 is a constant for converting cubic inches to cubic centimeters.



HAVE A QUESTION NOT LISTED HERE?

Loctite® Adhesives and Sealants Product Specialists are available to assist you with new product designs, or to help you re-engineer an existing application for improved performance and cost savings. They can also set up testing of your parts at the Henkel Customer Engineering Center. For application assistance, call **1-800-LOCTITE (562-8483)**; *within Canada, call 1-800-263-5043*; or, contact us through the web at www.henkelna.com/loctite.

STRAIGHT FROM *The Source*

[Shelf Life]

What is the Henkel shelf life policy for Loctite® branded products?

The shelf life period for the majority of Loctite® branded products is indicated by the *use by* date on the package.

For optimal storage, maintain product at a temperature between 8°C (46°F) to 21°C (70°F). Storage below 8°C (46°F) or greater than 28°C (82°F) can adversely affect product properties. UNOPENED cyanoacrylate products must be stored under refrigerated conditions at 2°C (36°F) to 8°C (46°F). Storage below 2°C (36°F) or greater than 8°C (46°F) can adversely affect product properties. Unopened cyanoacrylate products should be brought to ambient temperature before the package is opened. Once opened, the product should be left at ambient temperature. Products requiring storage at conditions other than those specified here are labeled accordingly.

Material removed from containers may be contaminated during use. Do not return product to original containers. Henkel cannot assume responsibility for product that has been contaminated or stored under conditions other than as recommended. This policy supersedes all previous policies regarding shelf life and storage of Loctite® branded products.

Contact Customer Service at 1-800-LOCTITE (562-8483) if you need additional information.

[Viscosity]

Viscosity is a product property associated with all Loctite® adhesive/sealants. Viscosity is defined as a measure of the resistance of a fluid to flow (usually through a specific orifice). A measure of this fluid “thickness” is expressed in centipoise values. The higher the number, the thicker the product. Thicker products are less flowable and, in most cases, will fill a larger gap if necessary. The following chart relates viscosity to some products we are all familiar with:

PRODUCT	APPROXIMATE VISCOSITY IN CENTIPOISE (cP)	LOCTITE® CYANOACRYLATES	LOCTITE® ANAEROBICS
Water at 70°C	1 - 5	420™	–
Blood or Kerosene	10	–	290™
Antifreeze or Ethylene Glycol	15	406™	Letter Grade A
Motor Oil SAE 10 or Corn Oil	50 - 100	414™/496™	609™
Motor Oil SAE 30 or Maple Syrup	150 - 200	–	675™
Motor Oil SAE 40 or Castor Oil	250 - 500	4203™/4471™	640™
Motor Oil SAE 60 or Glycerin	1,000 - 2,000	403™/422™	222MS™/ 242™/262™
Corn Syrup or Honey	2,000 - 3,000	410™/4211™	635™
Blackstrap Molasses	5,000 - 10,000	411™/382™	277™/620™
Chocolate Syrup	10,000 - 25,000	–	324™/326™
Ketchup or Mustard	50,000 - 70,000	409™	330™
Tomato Paste or Peanut Butter	150,000 - 250,000	–	592™
Shortening or Lard	1,000,000 - 2,000,000	–	660™
Caulking Compound	5,000,000 - 10,000,000	–	593™
Window Putty	100,000,000	–	–

Some products are considered thixotropic. This describes materials that are gel-like at rest but fluid when agitated. Ketchup is a good example that exhibits this property. Loctite® thixotropic products include Loctite® 262™ Threadlocker and Loctite® 509™ Flange Sealant.

Your Source for
LOCTITE® PRODUCTS
 FOR DESIGN, ASSEMBLY,
 MANUFACTURING & MAINTENANCE
ENGINEERING SERVICES

Henkel Corporation offers complete engineering services for projects demanding expertise and support beyond the limits of our standard technical services. As a result, our engineers and scientists can quote the following value-added services:

- On-site engineering assistance
- Joint product development programs
- Prototype testing, fixture preparation and consultation
- Contract lab services and testing
- Custom formulations



In today's volatile and fluid market landscape, a manufacturer's survival and success are directly related to its technical capability. Rapidly emerging, innovative processes and materials mandate an unprecedented breadth and depth of engineering savvy. Not every company can house the equipment and engineering staff necessary to compete in today's marketplace.



THE ENGINEERING SERVICES GROUP OF HENKEL UNDERSTANDS THE NECESSITY OF PARTNERING WITH MANUFACTURERS AND SHARING THIS EXPERTISE WITH THE INDUSTRY THROUGH COST-EFFECTIVE, CUSTOM-TAILORED PROGRAMS.

These programs range from specialized field teams that evaluate specifications and in-line process requirements, to the development of adhesives, and the design, construction and implementation of dispensing and curing systems. Whether you need competent recommendations on chemical properties, or a full-blown, turnkey process line, the engineering services group of Henkel can provide solutions through the seamless integration of mechanical, electrical, industrial manufacturing, and chemical engineering teams.

The Application Engineering Lab plays host to a battery of testing equipment. Here, experienced technicians conduct a multitude of tests, such as surface contamination, deforming, fixture, tensile and peel strengths.





CUSTOM TEST FIXTURES AND PROTOCOLS CAN BE DEVELOPED TO MEET SPECIFIC END-USE REQUIREMENTS

Crucial in the engineering process is determining whether the customer's application and the adhesive criteria can withstand the gauntlet of rigorous strength tests performed by Henkel. Custom test fixtures and protocols can be developed to meet specific end-use requirements.



OUR PROTOTYPING CAPABILITY PROVIDES VALUABLE DATA REGARDING THE FEASIBILITY OF FULL-SCALE MANUFACTURE

Engineers specializing in Loctite® products are frequently called upon to provide process simulations of customer parts on short production runs, such as gasketing. Our prototyping capability provides valuable data regarding the feasibility of full-scale manufacture.



MANUFACTURERS CAN BE PROVIDED CONFIDENCE IN THE DURABILITY AND LONGEVITY OF AN ASSEMBLY IN THE FIELD

Our engineers can also create environmental conditions that simulate, and even exceed, the most severe conditions. With heat aging, salt fog, humidity and thermal cycling chambers, manufacturers can be provided with confidence in the durability and longevity of an assembly in the field.

TAKE ADVANTAGE OF OUR RESOURCES

To access these and other Engineering Services, contact our Adhesives and Sealants Specialists at **1-800-LOCTITE (562-8483)**. Immediate technical assistance is available from 8 a.m. to 5 p.m. ET, Monday through Friday.

STRAIGHT FROM *The Source*

Your Source for
LOCTITE® PRODUCTS
 FOR DESIGN, ASSEMBLY,
 MANUFACTURING & MAINTENANCE
OEM TRAINING SERVICES



- Educate your engineers on how to cut costs, improve quality and increase production through the integration of adhesives into the new product design process.
- Each instructional event touches on the wide array of Loctite® product solutions including adhesives and sealants, dispensing and curing equipment, as well as the unmatched technical support of our product specialists.

PRODUCT WORKSHOPS

Loctite® OEM Workshop

Full or half-day on-site product training customized to address specific design needs at your manufacturing location.

Loctite® OEM Customer Training School

Full or half-day off-site training designed specifically for design, process, material and manufacturing engineers responsible for assemblies involving the use of adhesives.

INDUSTRY WORKSHOPS

Designing Pumps with Adhesives Seminar

Two- to four-hour training on adhesives, coatings, lubricants and the performance improvements that their implementation provides to pump manufacturers.

Designing Electric Motors with Adhesives Seminar

This half-day seminar reviews in detail the many ways motor manufacturers are using adhesives and sealants to improve performance, reduce costs and enhance manufacturability. The seminar includes many hands-on demonstrations and real-world case histories.

Medical Advanced Workshop

A four- to seven-hour off-site program providing solutions to medical device manufacturers on design and assembly challenges. The workshop is designed specifically for material, manufacturing and design engineers, and includes hands-on demonstrations of adhesives and equipment.

Medical Technology On-Site Seminar

Select from a menu of seven of the most requested medical device adhesive topics or create a customized seminar to meet your specific requirements. Courses are conducted at your location, and include instruction, hands-on demonstrations, samples, and technical guides.

HENKEL OFFERS MANY OTHER WORKSHOPS WHICH CAN BE CUSTOMIZED TO PROVIDE LOCTITE® TRAINING FOR VARIOUS INDUSTRIES AND DEVICES.

SERVICES

Plant Survey

A detailed manufacturing process evaluation performed by a Loctite® Adhesives and Sealants Specialist to identify and document potential cost savings and process improvements.



Your Source for
LOCTITE® PRODUCTS
 FOR DESIGN, ASSEMBLY,
 MANUFACTURING & MAINTENANCE
MRO TRAINING SERVICES

- All of the following services will teach your maintenance personnel how to save time, reduce costs, improve safety in your plant, and increase the reliability of your equipment.

<p style="writing-mode: vertical-rl; transform: rotate(180deg);">PRODUCT WORKSHOPS</p>	<p>Loctite® Maintenance Workshop</p> <p>Two hours of on-site product training customized to your facility's needs. Optional cost documentation process available.</p> <p>Loctite® Pump Rebuild Workshop</p> <p>Two- to four-hours of product training on how Loctite® products can improve pump reliability and reduce common failures. Includes pump rebuild manual.</p> <p>Loctite® Maintenance Customer Training School</p> <p>Full- or half-day product training with review of common maintenance challenges and the appropriate Loctite® product solutions.</p>
<p style="writing-mode: vertical-rl; transform: rotate(180deg);">MANUFACTURING RELIABILITY TRAINING</p>	<p>Manufacturing Reliability Training (MRT)</p> <p>Four hours of CEU-accredited training on mechanical basics, failure fundamentals and the role of machinery adhesives in equipment reliability. Includes training manual and product tool kit.</p>
<p style="writing-mode: vertical-rl; transform: rotate(180deg);">SERVICES</p>	<p>Documented Cost Savings</p> <p>Offers a process for validating and documenting cost savings realized as a result of Loctite® Workshops or Maintenance Reliability Training.</p> <p>Engineering Assistance</p> <p>Henkel offers many other services including air leak surveys, pump rebuild assistance and flooring application assistance. In addition, Henkel offers an optional cost documentation process with the MRT programs and Maintenance Workshop listed above.</p>

Your Source for
LOCTITE® PRODUCTS
FOR DESIGN, ASSEMBLY,
MANUFACTURING & MAINTENANCE
OBSOLETE PART
NUMBER LISTING

REMOVED LOCTITE® ITEM		AVAILABLE REPLACEMENT LOCTITE® ITEM	
IDH/ITEM #	PRODUCT DESCRIPTION	IDH/ITEM #	PRODUCT DESCRIPTION
11782	Loctite® 560™ Thread Sealant, Large Diameter		
11505	Loctite® 560™ Thread Sealant, Large Diameter		
18191	Loctite® 5951™ 40 lb. pail	18495	Loctite® 5950™ 40 lb. pail
24707	Loctite® 5960™ Fastgasket® Flange Sealant	1212165	Loctite® 5050™ Fastgasket® Silicone Adhesive Sealant 40 lb. pail
28400	Loctite® 3108™ Light Cure Adhesive 25 ml syringe		
28465	Loctite® 3108™ Light Cure Adhesive 1 liter bottle		
29312	Loctite® E-90FL™ Hysol® Epoxy Adhesive, Flexible		
29313	Loctite® E-90FL™ Hysol® Epoxy Adhesive, Flexible		
29320	Loctite® E-60HP™ Hysol® Epoxy Adhesive, Flexible		
29505	Loctite® 3175™ Light Cure Adhesive	29506	Loctite® 3175™ Light Cure Adhesive
30507	Loctite® Instant Gasket		
30521	Loctite® Pro Strength Degreaser		
30522	Loctite® Hydraulic Jack Oil 1 qt. can	30523	Loctite® Hydraulic Jack Oil 1 gal. can
30546	Loctite® Multi-Purpose Glass Cleaner 18.75 oz. net wt. aerosol		
31132	Loctite® 5960™ Fastgasket® Flange Sealant	1212166	Loctite® 5050™ Fastgasket® Silicone Adhesive Sealant 300 ml cartridge
31297	Loctite® 3650™ Hysol® Hot Melt Adhesive		
31302	Loctite® 3650™ Hysol® Hot Melt Adhesive		
31303	Loctite® 3651™ Hysol® Hot Melt Adhesive		
31362	Loctite® Manufacturing Reliability Toolbox	38956	Loctite® Maintenance Tacklebox
32084	Loctite® 3933 Light Cure Adhesive	32040	Loctite® 3933™ Light Cure Adhesive 1 liter bottle
33486	Loctite® Maintenance Tacklebox	38956	Loctite® Maintenance Tacklebox
34348	Loctite® 5964™ Procure® 300 ml cartridge	34347	Loctite® 5964™ Procure® 50 lb. pail
34894	Loctite® Color Guard® Coating Black 11 oz. net wt. aerosol can	34979	Loctite® Color Guard® Coating Black 14.5 oz. can
34895	Loctite® Color Guard® Coating Blue 11 oz. net wt. aerosol can	34982	Loctite® Color Guard® Coating Blue 14.5 oz. can
34896	Loctite® Color Guard® Coating Red 11 oz. net wt. aerosol can	34985	Loctite® Color Guard® Coating Red 14.5 oz. can
34897	Loctite® Color Guard® Coating Yellow 11 oz. net wt. aerosol can	34988	Loctite® Color Guard® Coating Yellow 14.5 oz. can
34984	Loctite® Color Guard® Coating Blue 54 gal. drum	34983	Loctite® Color Guard® Coating Blue 1 gal.
34987	Loctite® Color Guard® Coating Red 54 gal. drum	34986	Loctite® Color Guard® Coating Red 1 gal.
34991	Loctite® Color Guard® Coating Yellow 54 gal. drum	34989	Loctite® Color Guard® Coating Yellow 1 gal.
35531	Loctite® 565™ Thread Sealant 350 ml brush-top can	56541	Loctite® 565™ Thread Sealant 250 ml tube
36536	Loctite® 3911™ Medical Device Acrylic Adhesive		
36537	Loctite® 3911™ Medical Device Acrylic Adhesive		
36787	Loctite® ViperLube® High Performance Synthetic Lubricant - Gear Oil 90W 1 gal. bottle		
36788	Loctite® ViperLube® High Performance Synthetic Lubricant - Gear Oil 10W 1 gal. bottle		
36791	Loctite® 3913™ Medical Device Acrylic Adhesive		
36804	Loctite® 3913™ Medical Device Acrylic Adhesive		
37387	Loctite® 272™ Threadlocker 10 ml bottle	27240	Loctite® 272™ Threadlocker 50 ml bottle
37441*	Loctite® 4307™ Flashcure® 1 oz. bottle		
37443*	Loctite® 4307™ Flashcure® 1 lb. bottle		
37795	Loctite® 542™ Thread Sealant 250 ml bottle	21453	Loctite® 542™ Thread Sealant 50 ml bottle
38350	Loctite® ViperLube® High Performance Synthetic Lubricant - Gear Oil 90W 5 gal. pail		
38351	Loctite® ViperLube® High Performance Synthetic Lubricant - Gear Oil 90W 55 gal. drum		
38352	Loctite® ViperLube® High Performance Synthetic Lubricant - Gear Oil 10W 5 gal. pail		
38353	Loctite® ViperLube® High Performance Synthetic Lubricant - Gear Oil 10W 55 gal. drum		
38402	Loctite® 7649™ Primer N™		
39062	Loctite® Reliability Tacklebox	38956	Loctite® Maintenance Tacklebox
39136	Loctite® Fixmaster® Marine Chocking	37316	Loctite® Fixmaster® Marine Chocking 1 gal. kit
39364	Loctite® ViperLube® Clear High Performance Synthetic Grease	39342	Loctite® ViperLube® Clear High Performance Synthetic Grease
39635	Loctite® Fixmaster® Rapid Rubber Repair Dispenser	1372751	Loctite® Universal Fixmaster® Dispenser
39864	Loctite® ViperLube® Clear High Performance Synthetic Grease 35 lb. pail	39342	Loctite® ViperLube® Clear High Performance Synthetic Grease 400 g cartridge

* Available to existing customers

REMOVED LOCTITE® ITEM		AVAILABLE REPLACEMENT LOCTITE® ITEM	
IDH/ITEM #	PRODUCT DESCRIPTION	IDH/ITEM #	PRODUCT DESCRIPTION
39973	Loctite® 3165™ Hysol® Epoxy	39974	Loctite® 3165™ Hysol® Epoxy 5 gal. pail
39974	Loctite® 3165™ 5 gal. pail	39395	Loctite® 3165™ Urethane 1 qt. can
40305	Loctite® Fixmaster® Superior Performance Urethane Floor Coating Sandstone Complete 1 gal. kit		
40307	Loctite® Fixmaster® Superior Performance Urethane Floor Coating Tile Red Complete 1 gal. kit		
40309	Loctite® Fixmaster® Superior Performance Urethane Floor Coating Haze Grey Complete 1 gal. kit		
40310	Loctite® Fixmaster® Superior Performance Urethane Floor Coating Haze Grey 3.3 gal. Resin		
40311	Loctite® Fixmaster® Superior Performance Urethane Floor Coating Deck Grey Complete 1 gal. kit		
40312	Loctite® Fixmaster® Superior Performance Urethane Floor Coating Deck Grey 3.3 gal. Resin		
40313	Loctite® Fixmaster® Superior Performance Urethane Floor Coating Standard 1.6 gal. Hardener		
40314	Loctite® Fixmaster® Superior Performance Urethane Floor Coating Additive 10 oz. Anti-slip		
40315	Loctite® Fixmaster® Superior Performance Urethane Floor Coating Additive 2 oz. Anti-slip		
40316	Loctite® Fixmaster® Superior Performance Urethane Floor Coating Clear Complete 1 gal. kit		
40317	Loctite® Fixmaster® Superior Performance Urethane Floor Coating Clear 3.3 gal. Resin		
40318	Loctite® Fixmaster® Superior Performance Urethane Floor Coating Clear 1.6 gal. Hardener		
40329	Loctite® Fixmaster® Self-Leveling Flooring Epoxy Clear 1 gal. kit		
40330	Loctite® Fixmaster® Self-Leveling Flooring Epoxy Clear 3.5 gal. hardener		
40331	Loctite® Fixmaster® Self-Leveling Flooring Epoxy Clear 1.5 gal. hardener		
40336	Loctite® Fixmaster® Self-Leveling Flooring Epoxy Sandstone 1 gal. kit		
40338	Loctite® Fixmaster® Self-Leveling Flooring Epoxy Tile Red 1 gal. kit		
40341	Loctite® Fixmaster® Self-Leveling Flooring Epoxy Fastset 1.5 gal. hardener		
40344	Loctite® Fixmaster® High Solids Novalac Epoxy Grey Resin 3.5 gal.	96092	Loctite® Nordbak® Chemical Resistant Coating
40345	Loctite® Fixmaster® High Solids Novalac Epoxy Hardener 1.5 gal.	96092	Loctite® Nordbak® Chemical Resistant Coating
40353	Loctite® Fixmaster® Superior Performance Urethane Floor Coating White 1 gal. kit		
40354	Loctite® Fixmaster® Superior Performance Urethane Floor Coating Safety Yellow 1 gal. kit		
40407	Loctite® 5040™ 40 lb. pail	40404	Loctite® 5040™ 300 ml cartridge
40515	Loctite® 5905™ White 50 lb. pail	40969	Loctite® 5905™ White 300 ml cartridge
40590	Loctite® Nordbak® Thin Mil Brushable Ceramic Black 2 lb. kit	98733	Loctite® Nordbak® Brushable Ceramic Grey 2 lb. kit
40591	Loctite® Nordbak® Thin Mil Brushable Ceramic Blue 2 lb. kit	98733	Loctite® Nordbak® Brushable Ceramic Grey 2 lb. kit
40592	Loctite® Nordbak® Thin Mil Brushable Ceramic Grey 2 lb. kit	98733	Loctite® Nordbak® Brushable Ceramic Grey 2 lb. kit
49595	Loctite® 495™ Super Bonder® Instant Adhesive 0.07 fl. oz. Gluematic Pen		
56943	Loctite® 569™ Thread Sealant 1 liter bottle	56941	Loctite® 569™ Thread Sealant 250 ml bottle
83255	Loctite® 6002™ Hysol® Hot Melt Adhesive		
83285	Loctite® 6002™ Hysol® Hot Melt Adhesive		
83341	Loctite® 7901™ Hysol® Hot Melt Adhesive		
83351	Loctite® 0430™ Hysol® SprayPac™ Polyshot Hot Melt Adhesive		
83352	Loctite® 0437™ Hysol® SprayPac™ Polyshot Hot Melt Adhesive		
83382	Loctite® Hysol® 7809FRM-HV 40 lb. pellets		
83384	Loctite® Hysol® 7809FRM-HV SS 30 lb. pail	83675	Loctite® Hysol® 7809FR SuperStick 32 lb. carton
83387	Loctite® Hysol® 7809FRM-HV PS 25 lb. pail	83676	Loctite® Hysol® 7809FR PolyShot 25 lb. pail
83395	Loctite® QuickPac™ Hysol® Hot Melt Adhesive		
83397	Loctite® QuickPac™ Hysol® Hot Melt Adhesive		
98182	Loctite® ZETA™ 7420™ Visible Light Flood System		
924104	Loctite® 5600™ Almond 400 ml cartridge	922544	Loctite® 5600™ Grey 400 ml cartridge
929334	Loctite® 5960™ 40 lb. pail	1212165	Loctite® 5050™ 40 lb. pail
982727	Loctite® Bond-a-Matic® 3000 Reservoir		
1059616	Loctite® 3050™ Structural Adhesive 400 ml cartridge	1064321	Loctite® H8700™ 400 ml cartridge
1059617	Loctite® 3050™ Structural Adhesive 50 ml cartridge	1064166	H8700™ 50 ml cartridge
1062125	Loctite® 561™ PST® 30 cc syringe	37127	Loctite® 561™ QuickStix® PST® Pipe Sealant 19 g stick
1078499	Loctite® 220IC™ Hysol® Epoxy Adhesive 5 gal. pail	1078261	Loctite® 220IC™ Hysol® Epoxy Adhesive 1 liter bottle
1108885	Loctite® Fixmaster® Anchor Bolt Grout 20.7 oz. dual cartridge	1108758	Loctite Fixmaster® Anchor Bolt Grout, High Performance 20.7 oz. dual cartridge
1254437	A-663™ Structural Adhesive	1256506	A-6750™ Structural Adhesive
1317359	Loctite® 271™ Oxy Threadlocker 50 ml	1265761	Loctite® Thread Sealant for Oxygen Compatible Systems 50 ml tube

INDEX BY PRODUCT

INDEX

Index by Product

PRODUCT	PRODUCT DESCRIPTION	PAGE NUMBER
1C	Loctite® 1C™ Hysol® Epoxy Adhesive	42, 44
1X	Loctite® 1X™ Hysol® Hot Melt Adhesive	14, 16
3X	Loctite® 3X™ Hysol® Polyshot Hot Melt Adhesive	14, 16
0151	Loctite® 0151™ Hysol® Epoxy Adhesive	39, 43
220	Loctite® 220™ Threadlocker	142, 146, 148
222	Loctite® 222™ Threadlocker	147
222MS	Loctite® 222MS™ Threadlocker	142, 145, 148
232	Loctite® 232™ Retaining Compound	126, 127, 129
232	Loctite® 232™ Hysol® Hot Melt Adhesive	14, 16
236	Loctite® 236™ Hysol® Hot Melt Adhesive	16
242	Loctite® 242™ Blue Threadlocker	145, 148
243	Loctite® 243™ Blue Threadlocker	142, 144, 147
246	Loctite® 246™ Threadlocker	142, 144, 147
248	Loctite® QuickStix® 248™ Blue Threadlocker	142, 144, 147
249	Loctite® QuickTape® 249™	142, 144, 147
262	Loctite® 262™ Threadlocker	145, 148
263	Loctite® 263™ Red Threadlocker	142, 144, 147
266	Loctite® 266™ Threadlocker	142, 145, 148
268	Loctite® QuickStix® 268™ Threadlocker – High Strength	142, 144, 147
271	Loctite® 271™ Threadlocker	146, 148
272	Loctite® 272™ Threadlocker	142, 145, 148
277	Loctite® 277™ Threadlocker	146, 148
290	Loctite® 290™ Threadlocker	142, 144, 146, 147, 148
294	Loctite® 294™ Threadlocker	142, 144, 147
312	Loctite® 312™ Speedbonder™ Structural Adhesive	31, 33
324	Loctite® 324™ Speedbonder™ Structural Adhesive	40, 44
325	Loctite® 325™ Speedbonder™ Structural Adhesive	31, 33
326	Loctite® 326™ Speedbonder™ Structural Adhesive	39, 43
330	Loctite® 330™ Depend® Adhesive	39, 43
331	Loctite® 331™ Structural Adhesive	31, 33
332	Loctite® 332™ Structural Adhesive	41, 44
332	Loctite® 332™ Structural Adhesive	41, 44
334	Loctite® 334™ Structural Adhesive	31, 33
349	Loctite® 349™ Impruv® Light Cure Adhesive	22
352	Loctite® 352™ Light Cure Adhesive	20, 22
363	Loctite® 363™ Impruv® Light Cure Adhesive	22
366	Loctite® 366™ Light Cure Adhesive	22
380	Loctite® 380™ Black Max® Instant Adhesive	7, 9
382	Loctite® 382™ Tak Pak® Instant Adhesive	8, 10
392	Loctite® 392™ Structural Adhesive	31, 33
401	Loctite® 401™ Prism® Instant Adhesive	7, 9
403	Loctite® 403™ Prism® Instant Adhesive	7, 9
404	Loctite® 404™ Quick Set™ Instant Adhesive	8, 10
406	Loctite® 406™ Prism® Instant Adhesive	7, 9
408	Loctite® 408™ Prism® Instant Adhesive	9
409	Loctite® 409™ Super Bonder® Instant Adhesive	10
410	Loctite® 410™ Prism® Instant Adhesive	9
411	Loctite® 411™ Prism® Instant Adhesive	7, 9
414	Loctite® 414™ Super Bonder® Instant Adhesive	10
415	Loctite® 415™ Super Bonder® Instant Adhesive	10
416	Loctite® 416™ Super Bonder® Instant Adhesive	10
420	Loctite® 420™ Super Bonder® Instant Adhesive	10
422	Loctite® 422™ Super Bonder® Instant Adhesive	10
425	Loctite® 425™ Assure™ Instant Adhesive	145, 148
426	Loctite® 426™ Prism® Instant Adhesive	7, 9
430	Loctite® 430™ Super Bonder® Instant Adhesive	10
0430	Loctite® 0430™ Hysol® SprayPac™ Polyshot Hot Melt Adhesive	13, 15
431	Loctite® 431™ Prism® Instant Adhesive	7, 9, 163, 164
435	Loctite® 435™ Prism® Instant Adhesive	8, 9, 163, 164
438	Loctite® 438™ Prism® Instant Adhesive	9
444	Loctite® 444™ Tak Pak® Instant Adhesive	8, 10
0450	Loctite® 0450™ Hysol® SprayPac™ Polyshot Hot Melt Adhesive	13
454	Loctite® 454™ Prism® Instant Adhesive	7, 9
455	Loctite® 455™ Prism® Instant Adhesive	7, 9
460	Loctite® 460™ Prism® Instant Adhesive	9
480	Loctite® 480™ Prism® Instant Adhesive	8, 9
493	Loctite® 493™ Super Bonder® Instant Adhesive	10
495	Loctite® 495™ Super Bonder® Instant Adhesive	10
496	Loctite® 496™ Super Bonder® Instant Adhesive	10
498	Loctite® 498™ Super Bonder® Instant Adhesive	8, 10
499	Loctite® 499™ Super Bonder® Instant Adhesive	10
504	Loctite® 504™ Gasket Eliminator® Flange Sealant	75, 77
509	Loctite® 509™ Gasket Eliminator® Flange Sealant	75, 77
510	Loctite® 510™ Gasket Eliminator® Flange Sealant	75, 77
515	Loctite® 515™ Gasket Eliminator® Flange Sealant	75, 77
518	Loctite® 518™ Gasket Eliminator® Flange Sealant	75, 77
534	Loctite® QuickStix® 534™ Hi-Tack Gasket Dressing	75, 78
542	Loctite® 542™ Thread Sealant	150, 152, 154
545	Loctite® 545™ Thread Sealant	150, 152, 154
548	Loctite® QuickStix® 548™ Gasket Eliminator® Flange Sealant	75, 77
549	Loctite® 549™ Instant Seal Plastic Gasket Thread Sealant	77
554	Loctite® 554™ Thread Sealant	150, 152, 154
561	Loctite® QuickStix® 561™ PST® Pipe Sealant	150, 152, 154
564	Loctite® 564™ Thread Sealant	150, 151, 153
565	Loctite® 565™ PST® Thread Sealant	150, 151, 153
567	Loctite® 567™ PST® Thread Sealant	150, 151, 153
568	Loctite® 568™ Flange Sealant, Plastic Gasket	77
569	Loctite® 569™ Thread Sealant	150, 154
571	Loctite® 571™ Thread Sealant	150, 152, 154
572	Loctite® 572™ Thread Sealant	150, 152, 154

PRODUCT	PRODUCT DESCRIPTION	PAGE NUMBER
573	Loctite® 573™ Flange Sealant, Medium Strength	77
574	Loctite® 574™ Flange Sealant, Fast Curing	77
577	Loctite® 577™ Thread Sealant	150, 151, 153
579	Loctite® 579™ Thread Sealant	150, 151, 153
580	Loctite® 580™ PST® Thread Sealant	150, 152, 154
587	Loctite® 587™ Blue, High Performance RTV Silicone Gasket Maker	82, 84, 87
592	Loctite® 592™ PST® Thread Sealant	150, 151, 153
598	Loctite® 598™ Black, High Performance RTV Silicone Gasket Maker	82, 84, 87
603	Loctite® 603™ Retaining Compound	126, 127, 129
608	Loctite® 608™ Hysol® Epoxy Adhesive	39, 43
609	Loctite® 609™ Retaining Compound	126, 127, 129
615	Loctite® 615™ Hysol® Epoxy Adhesive	40, 44
620	Loctite® 620™ Retaining Compound	126, 128, 129
635	Loctite® 635™ Retaining Compound	126, 128, 130
638	Loctite® 638™ Retaining Compound	126, 128, 130
640	Loctite® 640™ Retaining Compound	126, 129
641	Loctite® 641™ Retaining Compound	126, 127, 130
648	Loctite® 648™ Retaining Compound	126, 127, 129
660	Loctite® 660™ Quick Metal® Retaining Compound	126, 128, 130
668	Loctite® QuickStix® 668™ Retaining Compound, High Temperature	126, 127, 129
675	Loctite® 675™ Retaining Compound	126, 129
680	Loctite® 680™ Retaining Compound	126, 128, 130
712	Loctite® 712™ Tak Pak® Accelerator	134, 140
713	Loctite® 713™ Prism® Accelerator	164
740	Loctite® 740™ Hysol® Hot Melt Adhesive	16
740LV	Loctite® 740LV™ Hysol® Hot Melt Adhesive	16
760A	Loctite® Zeta® 760A UV Wand System	168, 173
768	Loctite® 768™ X-NMS Cleanup Solvent	133, 136, 137
770	Loctite® 770™ Prism® Primer	134, 139, 140
1942	Loctite® 1942™ Hysol® Hot Melt Adhesive	14, 16, 114
2046	Loctite® 2046™ Threadlocker	144, 147
2047	Loctite® 2047™ Threadlocker	145, 148
2400NA	Loctite® 2400NA™ Blue Threadlocker	144, 147
2422	Loctite® 2422™ Threadlocker	142, 145, 147
2423	Loctite® 2423™ Threadlocker	145, 147
2432	Loctite® 2432™ Threadlocker	145, 147
2620	Loctite® 2620™ Threadlocker	142, 145, 148
2700NA	Loctite® 2700NA™ Red Threadlocker	145, 148
2760	Loctite® 2760™ Threadlocker	148
3032	Loctite® 3032™ Structural Adhesive	46, 48
3034	Loctite® 3034™ Structural Adhesive	46, 48
3060	Loctite® 3060™ Structural Adhesive	31, 33
3092	Loctite® 3092™ Instant Adhesive	7, 10
3100	Loctite® 3100™ Light Cure Adhesive	22
3101	Loctite® 3101™ Light Cure Adhesive	22
3102	Loctite® 3102™ Light Cure Adhesive	22
3103	Loctite® 3103™ Light Cure Adhesive	20, 22
3104	Loctite® 3104™ Light Cure Adhesive	22
3105	Loctite® 3105™ Light Cure Adhesive	20, 22
3106	Loctite® 3106™ Light Cure Adhesive	20, 22
3107	Loctite® 3107™ Light Cure Adhesive	20, 22
3108	Loctite® 3108™ Light Cure Adhesive	22
3140	Loctite® 3140™ Hysol® Epoxy Resin	107
3141	Loctite® 3141™ Hysol® Epoxy Resin	107
3142	Loctite® 3142™ Hysol® Epoxy Resin	107
3145	Loctite® 3145™ Hysol® Epoxy Resin	107
3160	Loctite® 3160™ Hysol® Epoxy Hardener	107
3162	Loctite® 3162™ Hysol® Epoxy Hardener	107
3163	Loctite® 3163™ Hysol® Epoxy Hardener	107
3164	Loctite® 3164™ Hysol® Epoxy Hardener	107
3165	Loctite® 3165™ Hysol® Epoxy Hardener	107
3173	Loctite® 3173™ Hysol® Polyurethane Resin	107
3175	Loctite® 3175™ Light Cure Adhesive	20, 22
3182	Loctite® 3182™ Hysol® Polyurethane Hardener	107
3183	Loctite® 3183™ Hysol® Polyurethane Hardener	107
3184	Loctite® 3184™ Hysol® Polyurethane Hardener	107
3201	Loctite® 3201™ Light Cure Adhesive	162
3211	Loctite® 3211™ Light Cure Adhesive	162
3301	Loctite® 3301™ Light Cure Adhesive	162
3311	Loctite® 3311™ Light Cure Adhesive	162
3311	Loctite® 3311™ Light Cure Adhesive	162
3321	Loctite® 3321™ Light Cure Adhesive	162
3336	Loctite® 3336™ Light Cure Adhesive	19, 21
3341	Loctite® 3341™ Light Cure Adhesive	161, 162
3355	Loctite® 3355™ Light Cure Adhesive	19, 21
3364	Loctite® 3364™ Hysol® Urethane Adhesives	107
3407	Loctite® 3407™ Optiloc® Cure-in-Place Gasket	87
3491	Loctite® 3491™ Light Cure Adhesive	20, 22
3492	Loctite® 3492™ Light Cure Adhesive	20, 22
3493	Loctite® 3493™ Light Cure Adhesive	22
3494	Loctite® 3494™ Light Cure Adhesive	21, 22
3525	Loctite® 3525™ Light Cure Adhesive	21, 22
3526	Loctite® 3526™ Light Cure Adhesive	21, 22
3554	Loctite® 3554™ Indigo® Visible Light Cure Adhesive	20, 22, 161, 162
3555	Loctite® 3555™ Indigo® Visible Light Cure Adhesive	20, 22, 161, 162
3556	Loctite® 3556™ Indigo® Visible Light Cure Adhesive	20, 22, 161, 162
3631	Loctite® 3631™ Hysol® Hot Melt Adhesive	13, 15
3751	Loctite® 3751™ Litetak® Light Cure Adhesive	22
3761	Loctite® 3761™ Litetak® Light Cure Adhesive	22
3921	Loctite® 3921™ Light Cure Adhesive	161, 162

PRODUCT	PRODUCT DESCRIPTION	PAGE NUMBER	PRODUCT	PRODUCT DESCRIPTION	PAGE NUMBER
3922	Loctite® 3922™ Light Cure Adhesive	161, 162	7088	Loctite® 7088™ QuickStix® Primer	134, 139, 140, 146
3924	Loctite® 3924™ Light Cure Adhesive	161, 162	7090	Loctite® 7090™ Primer	134, 140
3926	Loctite® 3926™ Light Cure Adhesive	161, 162	7109	Loctite® 7109™ Tak Pak® II Accelerator	134, 140
3933	Loctite® 3933™ Light Cure Adhesive	162	7113	Loctite® 7113™ Accelerator	134, 139, 140
3936	Loctite® 3936™ Light Cure Adhesive	162	7380	Loctite® 7380™ Depend® Activator	134, 139, 140
3941	Loctite® 3941™ Light Cure Adhesive	161, 162	7387	Loctite® 7387™ Depend® Activator	134, 139, 140
3942	Loctite® 3942™ Light Cure Adhesive	161, 162	7451	Loctite® 7451™ Prism® Accelerator	164
3943	Loctite® 3943™ Light Cure Adhesive	161, 162	7452	Loctite® 7452™ Tak Pak® Accelerator	134, 139, 140
3944	Loctite® 3944™ Light Cure Adhesive	162	7460	Loctite® 7460™ Hysol® SprayPac™ Polyshot Hot Melt Adhesive	13, 15
3971	Loctite® 3971™ Light Cure Adhesive	161, 162	7471	Loctite® 7471™ Primer T™	134, 139, 140
3972	Loctite® 3972™ Light Cure Adhesive	161, 162	7500	Loctite® 7500™ Hysol® SprayPac™ Polyshot Hot Melt Adhesive	13, 15
3974	Loctite® 3974™ Light Cure Adhesive	21, 22, 161, 162	7649	Loctite® 7649™ Primer N™	134, 139, 140, 146
3979	Loctite® 3979™ Light Cure Adhesive	21, 22, 161, 162	7701	Loctite® 7701™ Prism® Medical Device Primer	163, 164
3981	Loctite® 3981™ Hysol® Epoxy Adhesive	41, 44, 165, 166	7804	Loctite® 7804™ Hysol® Hot Melt Adhesive	15
3982	Loctite® 3982™ Hysol® Epoxy Adhesive	46, 47, 165, 166	7809FR	Loctite® 7809FR™ Hysol® Hot Melt Adhesive	13, 15, 114
3984	Loctite® 3984™ Hysol® Epoxy Adhesive	36, 37, 165, 166	7911	Loctite® 7911™ Hysol® Hot Melt Adhesive	13, 15, 114
3985	Loctite® 3985™ Hysol® Epoxy Adhesive	41, 44	7911	Loctite® 7901™ Hysol® Hot Melt Adhesive	13, 15, 114
4011	Loctite® 4011™ Prism® Medical Device Instant Adhesive	163, 164	7951	Loctite® 7951™ Prism® Primer	134, 139, 140
4013	Loctite® 4013™ Prism® Instant Adhesive	164	8517 H	Terostat® 8517 H Glass Primer	89, 90
4014	Loctite® 4014™ Prism® Instant Adhesive	164	8519 P	Terostat® 8519 P Primer/Activator	89, 90
4031	Loctite® 4031™ Prism® Instant Adhesive	164	8521	Terostat® 8521 Painted Substrate Primer	89, 90
4046	Loctite® 4046™ Hysol® Hot Melt Adhesive	14, 16	8597	Terostat® 8597 PL HMLC Direct Glazing Adhesive	89, 90
4061	Loctite® 4061™ Prism® Instant Adhesive	164	8599	Terostat® 8599 Direct Glazing Adhesive	89, 90
4081	Loctite® 4081™ Prism® Instant Adhesive	164	9000	Terostat® 9000 PL HMLC Direct Glazing Adhesive	89, 90
4161	Loctite® 4161™ Prism® Instant Adhesive	164	9096	Terostat® 9096 PL Direct Glazing Adhesive	89, 90
4203	Loctite® 4203™ Prism® Instant Adhesive	8, 9	9340	Loctite® 9340™ Hysol® Epoxy Adhesive	42, 44
4204	Loctite® 4204™ Prism® Instant Adhesive	8, 9	9430	Loctite® 9430™ Hysol® Epoxy Adhesive	40, 44
4205	Loctite® 4205™ Prism® Instant Adhesive	8, 9	9432NA	Loctite® 9432NA™ Hysol® Epoxy Adhesive	35, 37
4205	Loctite® 4205™ Prism® Instant Adhesive	8, 9	9459	Loctite® 9459™ Hysol® Epoxy Adhesive	42, 44
4206	Loctite® 4206™ Prism® Instant Adhesive	164	9460	Loctite® 9460™ Hysol® Epoxy Adhesive	40, 44
4306	Loctite® 4306™ Flashcure® Light Cure Adhesives	8, 9, 19, 21, 163, 164	9462	Loctite® 9462™ Hysol® Epoxy Adhesive	41, 44
4307	Loctite® 4307™ Flashcure® Light Cure Adhesive	163	A-533	Loctite® A-533™ Structural Adhesive	39, 43
4310	Loctite® 4310™ Flashcure® Light Cure Adhesive	8, 9, 19, 21, 163, 164	A-534R	Loctite® A-534R™ Activator	134, 139, 140
4311	Loctite® 4311™ Flashcure® Light Cure Adhesive	8, 9, 19, 21, 163, 164	A-671	Loctite® A-671™ Structural Adhesive	32, 33
4541	Loctite® 4541™ Prism® Instant Adhesive	163, 164	A-6750	Loctite® A-6750™ Structural Adhesive	32, 33
4601	Loctite® 4601™ Prism® Instant Adhesive	164	A-6909	Loctite® A-6909™ Hysol® Epoxy Adhesive	43
4851	Loctite® 4851™ Prism® Instant Adhesive	8, 9, 163, 164	E-00CL	Loctite® E-00CL™ Hysol® Epoxy Adhesive	39, 43
4861	Loctite® 4861™ Prism® Instant Adhesive	8, 9, 163, 164	E-00NS	Loctite® E-00NS™ Hysol® Epoxy Adhesive	43
4981	Loctite® 4981™ Super Bonder® Instant Adhesive	164	E-04SS	Loctite® E-04SS™ Epoxy Adhesive	45, 48
5031	Loctite® 5031™ Nuva-Sil® Silicone Potting Compound	19, 21, 111, 112	E-05CL	Loctite® E-05CL™ Hysol® Epoxy Adhesive	40, 42
5033	Loctite® 5033™ Nuva-Sil® Silicone Adhesive Sealant	19, 21	E-05MR	Loctite® E-05MR™ Hysol® Epoxy Adhesive	39, 43
5039	Loctite® 5039™ Nuva-Sil® Silicone Adhesive Sealant	19, 21, 82, 87	E-119HP	Loctite® E-119HP™ Hysol® Epoxy Adhesive	46, 47
5040	Loctite® 5040™ RTV Silicone Potting Compound	111, 112	E-120HP	Loctite® E-120HP™ Hysol® Epoxy Adhesive	46, 47
5045	Loctite® 5045™ Flange Sealant	81, 85	E-20HP	Loctite® E-20HP™ Hysol® Epoxy Adhesive	40, 44
5050	Loctite® 5050™ Fastgasket® Silicone Adhesive Sealant	20, 21, 82, 87	E-20NS	Loctite® E-20NS™ Hysol® Epoxy Adhesive	35, 37
5055	Loctite® 5055™ Silicone Adhesive Sealant	20, 21, 111, 112, 165, 166	E-214HP	Loctite® E-214HP™ Hysol® Epoxy Adhesive	31, 33, 35, 37
5056	Loctite® 5056™ Silicone Adhesive Sealant	20, 21, 111, 112, 165, 166	E-220IC	Loctite® E-220IC™ Hysol® Epoxy Adhesive	31, 33
5083	Loctite® 5083™ Nuva-Sil® Silicone Adhesive Sealant	21	E-30CL	Loctite® E-30CL™ Hysol® Epoxy Adhesive, Glass Bonder	39, 43, 107
5091	Loctite® 5091™ Nuva-Sil® Silicone Potting Compound	21, 112	E-30UT	Loctite® E-30UT™ Hysol® Epoxy Adhesive	40, 44
5127	Loctite® 5127™ Flexible Anaerobic Gasket Flange Sealant	77	E-40EXP	Loctite® E-40EXP™ Hysol® Epoxy Adhesive	107
5188	Loctite® 5188™ Flexible Flange Sealant	75, 77	E-40FL	Loctite® E-40FL™ Hysol® Epoxy Adhesive	40, 42
5203	Loctite® 5203™ Flange Sealant	75, 77	E-40HT	Loctite® E-40HT™ Hysol® Epoxy Adhesive	42, 44
5240	Loctite® 5240™ Nuva-Sil® Medical Device Sealant	20, 21, 111, 112, 165, 166	E-50CR	Loctite® E-50CR™ Hysol® Epoxy Adhesive	42, 44
5451	Loctite® 5451™ Thread Sealant	151, 153	E-50CR	Loctite® E-50CR™ Hysol® Epoxy Adhesive	42, 44
5452	Loctite® 5452™ Fast Cure Thread Sealant	150, 152, 154	E-50GW	Loctite® E-50GW™ Hysol® Epoxy Adhesive	36, 37
5510	Loctite® 5510™ Adhesive/Sealant	27, 28, 79, 80	E-60HP	Loctite® E-60HP™ Hysol® Epoxy Adhesive	35, 37, 41, 44
5512	Loctite® 5512™ Adhesive Sealant	27, 28, 79, 80	E-60NC	Loctite® E-60NC™ Hysol® Epoxy Adhesive, Electrically Non-Corrosive	42, 107
5570	Loctite® 5570™ Adhesive	27, 28, 79, 80	E-7570	Loctite® E-7570™ Epoxy Adhesive	41, 44
5572	Loctite® 5572™ Adhesive	27, 28, 79, 80	E-90FL	Loctite® E-90FL™ Hysol® Epoxy Adhesive	40, 42
5590	Loctite® 5590™ Adhesive	27, 28, 79, 80	E-910	Loctite® E-910™ Epoxy Adhesive	46, 47
5600	Loctite® 5600™ Silicone Sealant	81, 85	H3000	Loctite® H3000™ Speedbonder™ Structural Adhesive	45, 48
5600	Loctite® 5600™ Series – Part A, 3.5 gallon	81, 85	H3101	Loctite® H3101™ Speedbonder™ Structural Adhesive	45, 48
5600	Loctite® 5600™ Series – Part A, 575 lb.	81, 85	H3151	Loctite® H3151™ Speedbonder™ Structural Adhesive	35, 37
5604	Loctite® 5604™ Silicone Sealant	81, 85	H3300	Loctite® H3300™ Speedbonder™ Structural Adhesive	45, 48
5605	Loctite® 5605™ Silicone Adhesive/Sealants	81, 85	H4000	Loctite® H4000™ Speedbonder™ Structural Adhesive	45, 47
5606	Loctite® 5606™ Silicone Adhesive/Sealants	81, 85	H4100	Loctite® H4100™ Speedbonder™ Structural Adhesive	45, 47
5607	Loctite® 5607™ Silicone Adhesive/Sealants	81, 85	H4200	Loctite® H4200™ Speedbonder™ Structural Adhesive	45, 47
5611	Loctite® 5611™ Silicone Potting Compound	111, 112	H4500	Loctite® H4500™ Speedbonder™ Structural Adhesive	35, 37
5611F	Loctite® 5611F™ Silicone Potting Compound	111, 112	H4710	Loctite® H4710™ Speedbonder™ Structural Adhesive	35, 37
5611S	Loctite® 5611S™ Silicone Potting Compound	111, 112	H4720	Loctite® H4720™ Speedbonder™ Structural Adhesive	35, 37
5613	Loctite® 5613™ Silicone	81, 85	H4800	Loctite® H4800™ Speedbonder™ Structural Adhesive	45, 47
5620	Loctite® 5620™ Silicone Potting Compound	81, 86, 111, 112	H5004	Loctite® H5004™ Speedbonder™ Structural Adhesive	45, 48
5623	Loctite® 5623™ Silicone Potting Compound	111, 112	H6051	Loctite® H6051™ Speedbonder™ Structural Adhesive	45, 47
5625	Loctite® 5625™ Silicone Potting Compound	111, 112	H8000	Loctite® H8000™ Speedbonder™ Structural Adhesive	36, 37
5671	Loctite® QuickStix® 5671™ PST® Pipe Sealant	150, 152, 154	H8010	Loctite® H8010™ Speedbonder™ Structural Adhesive	36, 37
5699	Loctite® 5699™ Grey, High Performance RTV Silicone Gasket Maker	81, 84, 86, 87	H8100	Loctite® H8100™ Speedbonder™ Structural Adhesive	36, 37
5770	Loctite® 5770™ Thread Sealant	150, 151, 153	H8110	Loctite® H8110™ Speedbonder™ Structural Adhesive	36, 37
5772	Loctite® 5772™ Thread Sealant	150, 152, 154	H8500	Loctite® H8500™ Speedbonder™ Structural Adhesive	36, 37
5802	Loctite® 5802™ Thread Sealant	150, 152, 154	H8510	Loctite® H8510™ Speedbonder™ Structural Adhesive	36, 37
5810A	Loctite® 5810A	83, 84	H8600	Loctite® H8600™ Speedbonder™ Structural Adhesive	36, 37
5900	Loctite® 5900™ Flange Sealant	81, 86	H8610	Loctite® H8610™ Speedbonder™ Structural Adhesive	36, 37
5905	Loctite® 5905™ Flange Sealant RTV Silicone	81, 84, 86	H8700	Loctite® H8700™ Speedbonder™ Structural Adhesive	35, 37
5910	Loctite® 5910™ Flange Sealant RTV Silicone	81, 86	M-11FL	Loctite® M-11FL™ Hysol® Medical Device Urethane Adhesive	165, 166
5920	Loctite® 5920™ Copper, High Performance RTV Silicone Gasket Maker	82, 84, 86	M-121HP	Loctite® M-121HP™ Hysol® Medical Device Epoxy Adhesive	165, 166
5950	Loctite® 5950™ Fastgasket® Flange Sealants	82, 87	M-21HP	Loctite® M-21HP™ Hysol® Medical Device Epoxy Adhesive	165, 166
5963	Loctite® 5963™ Procure® Cure-in-Place Gasket	82, 87	M-31CL	Loctite® M-31CL™ Hysol® Medical Device Epoxy Adhesive	165, 166
5964	Loctite® 5964™ Procure® Cure-in-Place Gasket	82, 87	S440	S440 SCARA-N Robot Station	177
5970	Loctite® 5970™ Alcoxy Gasket Maker	82, 86	U-05FL	Loctite® U-05FL™ Hysol® Urethane Adhesive	36, 37
5999	Loctite® 5999™ Flange Sealant	82, 86	U-09FL	Loctite® U-09FL™ Hysol® Urethane Adhesive	45, 48
7075	Loctite® 7075™ Activator	134, 139, 140	U-09LV	Loctite® U-09LV™ Hysol® Urethane Adhesive	42

INDEX BY ITEM NUMBER

PRODUCT & ITEM NO.	PRODUCT DESCRIPTION	PAGE NUMBER
ANZ023N01	Loctite® Standard Nozzle Adapter/Check Valve/Jam Nut	18, 116
00101	Loctite® Quick Service Toolkit	157, 158
00112	Loctite® O-Ring Making Kit - Standard	157, 158
00144	Loctite® 312™ Speedbonder™ Structural Adhesive	31, 33
03333	Loctite® 312™ Speedbonder™ Structural Adhesive	31, 33
12224	Loctite® 366™ Light Cure Adhesive	22
12292	Loctite® 444™ Tak Pak® Instant Adhesive	8, 10
12294	Loctite® 444™ Tak Pak® Instant Adhesive	8, 10
12695	Loctite® 7090™ Primer	134, 140
17412	Loctite® 5091™ Nuva-Sil® Silicone Potting Compound	21, 112
17421	Loctite® 455™ Prism® Instant Adhesive	7, 9
17430	Loctite® 5127™ Flexible Anaerobic Gasket Flange Sealant	77
17451	Loctite® 426™ Prism® Instant Adhesive	7, 9
17528	Loctite® 5083™ Nuva-Sil® Silicone Adhesive Sealant	21
17529	Loctite® 426™ Prism® Instant Adhesive	7, 9
17635	Loctite® 5083™ Nuva-Sil® Silicone Adhesive Sealant	21
17944	Loctite® 3491™ Light Cure Adhesive	20, 22
18013	Loctite® 4013™ Prism® Instant Adhesive	164
18014	Loctite® 4014™ Prism® Instant Adhesive	164
18030	Loctite® 409™ Super Bonder® Instant Adhesive	10
18074	Loctite® 5091™ Nuva-Sil® Silicone Potting Compound, High Adhesion	21, 112
18390	Loctite® 712™ Tak Pak® Accelerator	134, 140
18396	Loctite® 770™ Prism® Primer	134, 139, 140
18397	Loctite® 770™ Prism® Primer	134, 139, 140
18398	Loctite® 426™ Prism® Instant Adhesive	7, 9
18490	Loctite® 7452™ Tak Pak® Accelerator	134, 139, 140
18495	Loctite® 5950™ Fastgasket® Flange Sealants	82, 87
18575	Loctite® 7452™ Tak Pak® Accelerator	134, 139, 140
18576	Loctite® 7452™ Tak Pak® Accelerator	134, 139, 140
18580	Loctite® 7452™ Tak Pak® Accelerator	134, 139, 140
18581	Loctite® 5699™ Grey, High Performance RTV Silicone Gasket Maker	81, 84, 86
18582	Loctite® 5699™ Grey, High Performance RTV Silicone Gasket Maker	81, 86
18583	Loctite® 5699™ Grey, High Performance RTV Silicone Gasket Maker	81, 86
18607	Loctite® 232™ Retaining Compound	126, 127, 129
18636	Loctite® 712™ Tak Pak® Accelerator	134, 140
18637	Loctite® 7452™ Tak Pak® Accelerator	134, 139, 140
18666	Loctite® 3492™ Light Cure Adhesive	20, 22
18680	Loctite® 4011™ Prism® Medical Device Instant Adhesive	163, 164
18681	Loctite® 4011™ Prism® Medical Device Instant Adhesive	163, 164
18682	Loctite® 4031™ Prism® Instant Adhesive	164
18683	Loctite® 4031™ Prism® Instant Adhesive	164
18686	Loctite® 4061™ Prism® Instant Adhesive	164
18687	Loctite® 4031™ Prism® Instant Adhesive	164
18688	Loctite® 4081™ Prism® Instant Adhesive	164
18690	Loctite® 4541™ Prism® Instant Adhesive	163, 164
18691	Loctite® 4541™ Prism® Instant Adhesive	163, 164
18692	Loctite® 4601™ Prism® Instant Adhesive	164
18693	Loctite® 4601™ Prism® Instant Adhesive	164
18694	Loctite® 4981™ Super Bonder® Instant Adhesive	164
18695	Loctite® 4981™ Super Bonder® Instant Adhesive	164
18718	Loctite® 5699™ Grey, High Performance RTV Silicone Gasket Maker	81, 84, 86
18751	Loctite® 3493™ Light Cure Adhesive	22
18861	Loctite® 7387™ Depend® Activator	134, 139, 140
18862	Loctite® 7387™ Depend® Activator	134, 139, 140
19163	Loctite® Tile Bond Red, High Temp RTV Silicone Adhesive Sealant	83, 84
19266	Loctite® 7649™ Primer N™	134, 139, 140, 146
19267	Loctite® 7471™ Primer T™	134, 139, 140
19268	Loctite® 7471™ Primer T™	134, 139, 140
19269	Loctite® 7649™ Primer N™	134, 139, 140, 146
19368	Loctite® 7090™ Primer	134, 140
19605	Loctite® 7113™ Accelerator	134, 139, 140
19606	Loctite® 7113™ Accelerator	134, 139, 140
19727	Loctite® 3201™ Light Cure Adhesive	162
19728	Loctite® 3201™ Light Cure Adhesive	162
19730	Loctite® 3211™ Light Cure Adhesive	162
19731	Loctite® 3211™ Light Cure Adhesive	162
19733	Loctite® 3301™ Light Cure Adhesive	162
19734	Loctite® 3301™ Light Cure Adhesive	162
19736	Loctite® 3311™ Light Cure Adhesive	162
19737	Loctite® 3311™ Light Cure Adhesive	162
19739	Loctite® 3321™ Light Cure Adhesive	162
19740	Loctite® 3321™ Light Cure Adhesive	162
19743	Loctite® 4161™ Prism® Instant Adhesive	164
19744	Loctite® 4161™ Prism® Instant Adhesive	164
19822	Loctite® 7380™ Depend® Activator	134, 139, 140
19824	Loctite® 7380™ Depend® Activator	134, 139, 140
19861	Loctite® 3101™ Light Cure Adhesive	22
19862	Loctite® 3100™ Light Cure Adhesive	22
19886	Loctite® 7701™ Prism® Medical Device Primer	163, 164
19887	Loctite® 7701™ Prism® Medical Device Primer	163, 164
19889	Loctite® 713™ Prism® Accelerator	164
19890	Loctite® 7451™ Prism® Accelerator	164
19907	Loctite® 7380™ Depend® Activator	134, 139, 140
20162	Loctite® ODC-Free Cleaner & Degreaser (Naphtha)	133, 135, 137
20166	Loctite® 5900® Flange Sealant	81, 86
20167	Loctite® 5900® Flange Sealant	81, 86
20168	Loctite® 5900® Flange Sealant	81, 86
20170	Loctite® 5999™ Flange Sealant	82, 86

PRODUCT & ITEM NO.	PRODUCT DESCRIPTION	PAGE NUMBER
20251	Loctite® 330™ Depend® Adhesive	39, 43
20252	Loctite® 330™ Depend® Adhesive	39, 43
20253	Loctite® 330™ Depend® Adhesive	39, 43
20260	Loctite® ODC-Free Cleaner & Degreaser (Naphtha)	133, 135, 137
20268	Loctite® 4013™ Prism® Instant Adhesive	164
20269	Loctite® 4014™ Prism® Instant Adhesive	164
20279	Loctite® Natural Blue® Biodegradable Cleaner & Degreaser (Fragrance-Free)	133, 135, 137
20352	Loctite® 712™ Tak Pak® Accelerator	134, 140
20419	Loctite® 444™ Tak Pak® Instant Adhesive	8, 10
20420	Loctite® 382™ Tak Pak® Instant Adhesive	8, 10
21088	Loctite® 7387™ Depend® Activator	134, 139, 140
21347	Loctite® 7649™ Primer N™	134, 139, 140, 146
21348	Loctite® 7649™ Primer N™	134, 139, 140, 146
21349	Loctite® 7075™ Activator	134, 139, 140
21359	Loctite® 3761™ Litetac® Light Cure Adhesive	22
21360	Loctite® 3761™ Litetac® Light Cure Adhesive	22
21362	Loctite® 3751™ Litetac® Light Cure Adhesive	22
21363	Loctite® 3751™ Litetac® Light Cure Adhesive	22
21425	Loctite® Fast Cure Mixer Cups	122, 123
21426	Loctite® Fast Cure Mixer Cups	122, 123
21434	Loctite® 277™ Threadlocker	146, 148
21440	Loctite® 603™ Retaining Compound	126, 127, 129
21441	Loctite® 603™ Retaining Compound	126, 127, 129
21442	Loctite® 603™ Retaining Compound	126, 127, 129
21443	Loctite® 648™ Retaining Compound	126, 127, 129
21444	Loctite® 648™ Retaining Compound	126, 127, 129
21445	Loctite® 648™ Retaining Compound	126, 127, 129
21447	Loctite® 638™ Retaining Compound	126, 128, 130
21448	Loctite® 638™ Retaining Compound	126, 128, 130
21449	Loctite® 638™ Retaining Compound	126, 128, 130
21453	Loctite® 542™ Thread Sealant	150, 152, 154
21454	Loctite® 572™ Thread Sealant	150, 152, 154
21456	Loctite® 577™ Thread Sealant	150, 151, 153
21457	Loctite® 577™ Thread Sealant	150, 151, 153
21458	Loctite® 641™ Retaining Compound	126, 127, 130
21463	Loctite® 222™ Threadlocker	147
21464	Loctite® 222™ Threadlocker	147
21472	Loctite® 5920™ Copper, High Performance RTV Silicone Gasket Maker	82, 86
21525	Loctite® 509™ Gasket Eliminator® Flange Sealant	75, 77
21744	Loctite® 5999™ Flange Sealant	82, 86
21746	Loctite® 5910® Flange Sealant RTV Silicone	81, 86
21747	Loctite® 5910® Flange Sealant RTV Silicone	81, 86
21748	Loctite® 5910® Flange Sealant RTV Silicone	81, 86
21920	Loctite® 4541™ Prism® Instant Adhesive	163, 164
21921	Loctite® 426™ Prism® Instant Adhesive	7, 9
21922	Loctite® 409™ Super Bonder® Instant Adhesive	10
21924	Loctite® 499™ Super Bonder® Instant Adhesive	10
21925	Loctite® 454™ Prism® Instant Adhesive	7
22041	Loctite® 220™ Threadlocker	142, 146, 148
22205	Loctite® 222MS™ Threadlocker	142, 145, 148
22221	Loctite® 222MS™ Threadlocker	142, 145, 148
22231	Loctite® 222MS™ Threadlocker	142, 145, 148
22241	Loctite® 222MS™ Threadlocker	142, 145, 148
22309	Loctite® 455™ Prism® Instant Adhesive	7, 9
22355	Loctite® ODC-Free Cleaner & Degreaser (Naphtha)	133, 135, 137
22423	Loctite® 518™ Gasket Eliminator® Flange Sealant	75, 77
22424	Loctite® 518™ Gasket Eliminator® Flange Sealant	75, 77
22440	Loctite® 7109™ Tak Pak® II Accelerator	134, 140
22477	Loctite® 7471™ Primer T™	134, 139, 140
22671	Loctite® 7075™ Activator	134, 139, 140
23034	Loctite® 7109™ Tak Pak® II Accelerator	134, 140
23440	Loctite® 3341™ Light Cure Adhesive	161, 162
23690	Loctite® 3102™ Light Cure Adhesive	22
23691	Loctite® 3103™ Light Cure Adhesive	20, 22
23692	Loctite® 3103™ Light Cure Adhesive	20, 22
23693	Loctite® 3104™ Light Cure Adhesive	22
23694	Loctite® 3104™ Light Cure Adhesive	22
23695	Loctite® 3105™ Light Cure Adhesive	20, 22
23696	Loctite® 3105™ Light Cure Adhesive	20, 22
23697	Loctite® 3106™ Light Cure Adhesive	20, 22
23698	Loctite® 3106™ Light Cure Adhesive	20, 22
23792	Loctite® 3341™ Light Cure Adhesive	161, 162
23811	Loctite® Natural Blue® Biodegradable Cleaner & Degreaser (Fragrance-Free)	133, 135, 137
24018	Loctite® 574™ Flange Sealant, Fast Curing	77
24205	Loctite® 242® Blue Threadlocker	145, 148
24221	Loctite® 242® Blue Threadlocker	145, 148
24231	Loctite® 242® Blue Threadlocker	145, 148
24241	Loctite® 242® Blue Threadlocker	145, 148
24243	Loctite® 242® Blue Threadlocker	145, 148
25062	Loctite® Anaerobic Activator	134, 140
25523	Loctite® 2432™ Threadlocker	145, 147
25524	Loctite® 5772™ Thread Sealant	150, 152, 154
25791	Loctite® Electrical Contact & Parts Cleaner	133, 135, 137
25882	Loctite® 554™ Thread Sealant	150, 152, 154
26205	Loctite® 262™ Threadlocker	145, 148
26221	Loctite® 262™ Threadlocker	145, 148
26231	Loctite® 262™ Threadlocker	145, 148
26241	Loctite® 262™ Threadlocker	145, 148

PRODUCT & ITEM NO.	PRODUCT DESCRIPTION	PAGE NUMBER	PRODUCT & ITEM NO.	PRODUCT DESCRIPTION	PAGE NUMBER
26243	Loctite® 262™ Threadlocker	145, 148	29340	Loctite® E-214HP™ Hysol® Epoxy Adhesive	31, 33, 35, 37
26325	Loctite® 4204™ Prism® Instant Adhesive	8, 9	29348	Loctite® U-05FL™ Hysol® Urethane Adhesive	36, 37
26338	Loctite® 574™ Flange Sealant, Fast Curing	77	29349	Loctite® U-05FL™ Hysol® Urethane Adhesive	36, 37
26392	Loctite® 573™ Flange Sealant, Medium Strength	77	29350	Loctite® U-05FL™ Hysol® Urethane Adhesive	36, 37
26772	Loctite® 266™ Threadlocker	142, 145, 148	29351	Loctite® U-05FL™ Hysol® Urethane Adhesive	36, 37
26773	Loctite® 266™ Threadlocker	142, 145, 148	29352	Loctite® U-05FL™ Hysol® Urethane Adhesive	36, 37
26774	Loctite® 266™ Threadlocker	142, 145, 148	29353	Loctite® E-120HP™ Hysol® Epoxy Adhesive	46, 47
27105	Loctite® 271™ Threadlocker	146, 148	29354	Loctite® E-120HP™ Hysol® Epoxy Adhesive	46, 47
27121	Loctite® 271™ Threadlocker	146, 148	29355	Loctite® E-120HP™ Hysol® Epoxy Adhesive	46, 47
27131	Loctite® 271™ Threadlocker	146, 148	29356	Loctite® E-120HP™ Hysol® Epoxy Adhesive	46, 47
27141	Loctite® 271™ Threadlocker	146, 148	29357	Loctite® E-120HP™ Hysol® Epoxy Adhesive	46, 47
27143	Loctite® 271™ Threadlocker	146, 148	29370	Loctite® U-09FL™ Hysol® Urethane Adhesive	48
27240	Loctite® 272™ Threadlocker	142, 145, 148	29371	Loctite® U-09FL™ Hysol® Urethane Adhesive	48
27270	Loctite® 272™ Threadlocker	142, 145, 148	29460	Loctite® U-09FL™ Hysol® Urethane Adhesive	45, 48
27285	Loctite® 272™ Threadlocker	142, 145, 148	29461	Loctite® U-09FL™ Hysol® Urethane Adhesive	45, 48
27311	Loctite® 277™ Threadlocker	146, 148	29462	Loctite® U-09FL™ Hysol® Urethane Adhesive	45, 48
27343	Loctite® 277™ Threadlocker	146, 148	29487	Loctite® 3494™ Light Cure Adhesive	21, 22
27558	Loctite® 7951™ Prism® Primer	134, 139, 140	29506	Loctite® 3175™ Light Cure Adhesive	20, 22
27863	Loctite® 232™ Retaining Compound	126, 127, 129	29513	Loctite® 246™ Threadlocker	142, 144, 147
27935	Loctite® 294™ Threadlocker	142, 144, 147	29514	Loctite® 246™ Threadlocker	142, 144, 147
27936	Loctite® 294™ Threadlocker	142, 144, 147	29515	Loctite® 246™ Threadlocker	142, 144, 147
27937	Loctite® 294™ Threadlocker	142, 144, 147	29709	Krytox® RFE PFPE Lubricant and High Performance Lubricant	91, 98, 99
27944	Loctite® 294™ Threadlocker	144, 147	29710	Krytox® RFE PFPE Lubricant and High Performance Lubricant	91, 98, 99
28027	Loctite® 4203™ Prism® Instant Adhesive	8, 9	29711	Krytox® RFE PFPE Lubricant and High Performance Lubricant	91, 98, 99
28028	Loctite® 4205™ Prism® Instant Adhesive	8, 9	30138	Krytox® RFE Advanced PTFE Dry Lubricant	91, 98, 99
28029	Loctite® 4205™ Prism® Instant Adhesive	8, 9	30220	Loctite® 3525™ Light Cure Adhesive	21, 22
28030	Loctite® 4205™ Prism® Instant Adhesive	8, 9	30221	Loctite® 3525™ Light Cure Adhesive	21, 22
28298	Loctite® 5999™ Flange Sealant	82, 86	30509	Loctite® Instant Gasket	82, 84
28366	Loctite® 3491™ Light Cure Adhesive	20, 22	30510	Loctite® Gasket Sealant 1 (Solvent-Based)	76, 78
28367	Loctite® 3492™ Light Cure Adhesive	20, 22	30511	Loctite® Gasket Sealant 1 (Solvent-Based)	76, 78
28368	Loctite® 3493™ Light Cure Adhesive	22	30512	Loctite® Gasket Sealant 1 (Solvent-Based)	76, 78
28400	Loctite® 3108™ Light Cure Adhesive	22	30513	Loctite® Gasket Sealant 2 (Solvent-Based)	76, 78
28419	Loctite® 3107™ Light Cure Adhesive	20, 22	30514	Loctite® Gasket Sealant 2 (Solvent-Based)	76, 78
28465	Loctite® 3108™ Light Cure Adhesive	22	30515	Loctite® Gasket Sealant 2 (Solvent-Based)	76, 78
28466	Loctite® 3107™ Light Cure Adhesive	20, 22	30516	Loctite® Aviation Gasket Sealant (Solvent-Based)	76, 78
28628	Loctite® 4206™ Prism® Instant Adhesive	164	30517	Loctite® Aviation Gasket Sealant (Solvent-Based)	76, 78
28629	Loctite® 4206™ Prism® Instant Adhesive	164	30518	Loctite® Superflex® RTV Silicone Adhesive Sealant – Blue	83, 84
28654	Loctite® Form-A-Thread® Stripped Thread Repair Kit	157, 158	30523	Loctite® Hydraulic Jack Oil	91, 100
28754	Loctite® 564™ Thread Sealant	150, 151, 153	30524	Loctite® Hi-Tack Gasket Sealant (Solvent-Based)	76, 78
28755	Loctite® 564™ Thread Sealant	150, 151, 153	30525	Loctite® Hi-Tack Gasket Sealant (Solvent-Based)	76, 78
28802	Loctite® 641™ Retaining Compound	126, 127, 130	30526	Loctite® Hi-Tack Gasket Sealant (Solvent-Based)	76, 78
29005	Loctite® 290™ Threadlocker	142, 144, 146, 147, 148	30527	Loctite® Belt Dressing & Conditioner	52, 55, 56
29021	Loctite® 290™ Threadlocker	142, 144, 146, 147, 148	30529	Loctite® Pro Strength Varnish Remover	133, 136, 137
29031	Loctite® 290™ Threadlocker	142, 144, 146, 147, 148	30530	Loctite® White Lithium Grease	91, 97, 100
29041	Loctite® 290™ Threadlocker	142, 144, 146, 147, 148	30533	Loctite® Superflex® RTV Silicone Adhesive Sealant – Blue	83, 84
29043	Loctite® 290™ Threadlocker	142, 144, 146, 147, 148	30535	Loctite® Copper Gasket Adhesive (Solvent-Based)	76, 78
29287	Loctite® 5950™ Fastgasket® Flange Sealants	82, 87	30536	Loctite® Dielectric Grease	91, 97, 100
29289	Loctite® E-00CL™ Hysol® Epoxy Adhesive	39, 43	30537	Loctite® Contact Adhesive	29, 30
29290	Loctite® E-00CL™ Hysol® Epoxy Adhesive	39, 43	30538	Loctite® Heavy-Duty Rubberized Undercoating	52, 55, 56
29291	Loctite® E-00CL™ Hysol® Epoxy Adhesive	39, 43	30539	Loctite® Extend® Rust Treatment	52, 55, 56
29294	Loctite® E-00NS™ Hysol® Epoxy Adhesive	43	30540	Loctite® Black Contact Adhesive	29, 30
29295	Loctite® E-00NS™ Hysol® Epoxy Adhesive	43	30542	Loctite® 5920™ Copper, High Performance RTV Silicone Gasket Maker	82, 84, 86
29296	Loctite® E-00NS™ Hysol® Epoxy Adhesive	43	30543	Loctite® White Lithium Grease	91, 97, 100
29299	Loctite® E-05CL™ Hysol® Epoxy Adhesive	40, 42	30544	Loctite® All-Purpose Spray Adhesive	29, 30
29300	Loctite® E-05CL™ Hysol® Epoxy Adhesive	40, 42	30545	Loctite® Non-Chlorinated Parts Cleaner	133, 136, 137
29301	Loctite® E-05CL™ Hysol® Epoxy Adhesive	40, 42	30548	Loctite® Pro Strength Parts Cleaner	133, 136, 137
29302	Loctite® E-05CL™ Hysol® Epoxy Adhesive	40, 42	30557	Loctite® Pipe Joint Compound	150, 154
29303	Loctite® E-05CL™ Hysol® Epoxy Adhesive	40, 42	30558	Loctite® High Temperature Gasket Maker (Solvent-Based)	76, 78
29304	Loctite® E-40FL™ Hysol® Epoxy Adhesive	40, 42	30560	Loctite® Superflex® RTV Silicone Adhesive Sealant – Blue	83, 84
29305	Loctite® E-40FL™ Hysol® Epoxy Adhesive	40, 42	30561	Loctite® Thread Sealant with PTFE	150, 154
29306	Loctite® E-40FL™ Hysol® Epoxy Adhesive	40, 42	30565	Loctite® Aqua Power® Biodegradable Cleaner & Degreaser	133, 135, 137
29309	Loctite® E-90FL™ Hysol® Epoxy Adhesive	40, 42	30671	Loctite® M-21HP™ Hysol® Medical Device Epoxy Adhesive	165, 166
29310	Loctite® E-90FL™ Hysol® Epoxy Adhesive	40, 42	30673	Loctite® M-31CL™ Hysol® Medical Device Epoxy Adhesive	165, 166
29311	Loctite® E-90FL™ Hysol® Epoxy Adhesive	40, 42	30674	Loctite® M-31CL™ Hysol® Medical Device Epoxy Adhesive	165, 166
29314	Loctite® E-20HP™ Hysol® Epoxy Adhesive	40, 44	30678	Loctite® M-11FL™ Hysol® Medical Device Urethane Adhesive	165, 166
29315	Loctite® E-20HP™ Hysol® Epoxy Adhesive	40, 44	30680	Loctite® M-121HP™ Hysol® Medical Device Epoxy Adhesive	165, 166
29316	Loctite® E-20HP™ Hysol® Epoxy Adhesive	40, 44	30756	Loctite® 3526™ Light Cure Adhesive	21, 22
29317	Loctite® E-20HP™ Hysol® Epoxy Adhesive	40, 44	30764	Loctite® 3526™ Light Cure Adhesive	21, 22
29318	Loctite® E-20HP™ Hysol® Epoxy Adhesive	40, 44	30765	Loctite® 3494™ Light Cure Adhesive	21, 22
29319	Loctite® E-60HP™ Hysol® Epoxy Adhesive	35, 37, 41, 44	31064	Loctite® 3336™ Light Cure Adhesive	19, 21
29321	Loctite® E-60HP™ Hysol® Epoxy Adhesive	35, 37, 41, 44	31065	Loctite® 3336™ Light Cure Adhesive	19, 21
29322	Loctite® E-60HP™ Hysol® Epoxy Adhesive	35, 37, 41, 44	31231	Loctite® 312™ Speedbonder™ Structural Adhesive	31, 33
29323	Loctite® E-60HP™ Hysol® Epoxy Adhesive	35, 37, 41, 44	31243	Loctite® 312™ Speedbonder™ Structural Adhesive	31, 33
29324	Loctite® E-60NC™ Hysol® Epoxy Adhesive, Electrically Non-Corrosive	42, 107	31279	Loctite® 3631™ Hysol® Hot Melt Adhesive	13, 15
29325	Loctite® E-60NC™ Hysol® Epoxy Adhesive, Electrically Non-Corrosive	42, 107	31291	Loctite® 3631™ Hysol® Hot Melt Adhesive	13, 15
29326	Loctite® E-60NC™ Hysol® Epoxy Adhesive, Electrically Non-Corrosive	42, 107	31361	Krytox® RFE PFPE Lubricant and High Performance Lubricant	91, 98, 99
29327	Loctite® E-60NC™ Hysol® Epoxy Adhesive, Electrically Non-Corrosive	42	32037	Loctite® 3936™ Light Cure Adhesive	162
29328	Loctite® E-60NC™ Hysol® Epoxy Adhesive, Electrically Non-Corrosive	42	32040	Loctite® 3933™ Light Cure Adhesive	162
29329	Loctite® E-30CL™ Hysol® Epoxy Adhesive, Glass Bonder	39, 43, 107	32047	Loctite® 3922™ Light Cure Adhesive	161, 162
29330	Loctite® E-30CL™ Hysol® Epoxy Adhesive, Glass Bonder	39, 43, 107	32083	Loctite® 3922™ Light Cure Adhesive	161, 162
29331	Loctite® E-30CL™ Hysol® Epoxy Adhesive, Glass Bonder	39, 43, 107	32304	Loctite® 3936™ Light Cure Adhesive	162
29332	Loctite® E-30CL™ Hysol® Epoxy Adhesive, Glass Bonder	39, 43	32429	Loctite® 545™ Thread Sealant	150, 152, 154
29333	Loctite® E-30CL™ Hysol® Epoxy Adhesive, Glass Bonder	39, 43	32430	Loctite® 324™ Speedbonder™ Structural Adhesive	40, 44
29334	Loctite® E-20NS™ Hysol® Epoxy Adhesive	35, 37	32490	Loctite® 324™ Speedbonder™ Structural Adhesive	40, 44
29335	Loctite® E-20NS™ Hysol® Epoxy Adhesive	35, 37	32525	Loctite® 2760™ Threadlocker	148
29336	Loctite® E-20NS™ Hysol® Epoxy Adhesive	35, 37	32526	Loctite® 2760™ Threadlocker	148
29339	Loctite® E-214HP™ Hysol® Epoxy Adhesive	31, 33, 35, 37	32527	Loctite® 2760™ Threadlocker	148
			32528	Loctite® 2760™ Threadlocker	148

INDEX BY ITEM NUMBER

INDEX

Index by Item Number

PRODUCT & ITEM NO.	PRODUCT DESCRIPTION	PAGE NUMBER
32530	Loctite® 325™ Speedbonder™ Structural Adhesive	31, 33
32586	Loctite® 325™ Speedbonder™ Structural Adhesive	31, 33
32629	Loctite® 326™ Speedbonder™ Structural Adhesive	39, 43
32685	Loctite® 326™ Speedbonder™ Structural Adhesive	39, 43
33058	Loctite® 330™ Depend® Adhesive	39, 43
33064	Loctite® 330™ Depend® Adhesive	39, 43
33081	Loctite® 330™ Depend® Adhesive	39, 43
33201	Loctite® 332™ Structural Adhesive	41, 44
33241	Loctite® 567™ PST® Thread Sealant	150, 151, 153
33275	Loctite® 332™ Structural Adhesive	41, 44
33290	Loctite® 332™ Structural Adhesive	41, 44
33403	Loctite® 334™ Structural Adhesive	31, 33
33470	Loctite® 334™ Structural Adhesive	31, 33
33510	Loctite® Fixmaster® Super Grout	64, 69, 71
34018	Loctite® 598™ Black, High Performance RTV Silicone Gasket Maker	82, 84
34026	Loctite® Marine Grade Anti-Seize	92, 93, 95
34337	Loctite® 5963™ Procure® Cure-in-Place Gasket	82, 87
34347	Loctite® 5964™ Procure® Cure-in-Place Gasket	82, 87
34395	Loctite® Marine Grade Anti-Seize	92, 93, 95
34517	Loctite® White Hi-Temp Anti-Seize	92, 94, 95
34518	Loctite® White Hi-Temp Anti-Seize	92, 94, 95
34731	Loctite® 3985™ Hysol® Epoxy Adhesive	41, 44
34759	Loctite® 564™ Thread Sealant	150, 151, 153
34931	Loctite® 349™ Impruv® Light Cure Adhesive	22
34943	Loctite® Industrial Hand Wipes	96, 133, 136, 137
34944	Loctite® Industrial Hand Wipes	96, 133, 136, 137
34979	Loctite® Color Guard® Coating	52, 55, 56
34980	Loctite® Color Guard® Coating	52, 55, 56
34981	Loctite® Color Guard® Coating	52, 55, 56
34982	Loctite® Color Guard® Coating	52, 55, 56
34983	Loctite® Color Guard® Coating	52, 55, 56
34985	Loctite® Color Guard® Coating	52, 55, 56
34986	Loctite® Color Guard® Coating	52, 55, 56
34988	Loctite® Color Guard® Coating	52, 55, 56
34989	Loctite® Color Guard® Coating	52, 55, 56
34990	Loctite® 349™ Impruv® Light Cure Adhesive	22
34994	Loctite® Color Guard® Primer	55, 56
34995	Loctite® Color Guard® Thinner	55, 56
35173	Loctite® 3407™ Optiloc® Cure-in-Place Gasket	87
35229	Loctite® 5970™ Alcoxy Gasket Maker	82, 86
35230	Loctite® 5970™ Alcoxy Gasket Maker	82, 86
35241	Loctite® 352™ Light Cure Adhesive	20, 22
35286	Loctite® 352™ Light Cure Adhesive	20, 22
35939	Loctite® H8000™ Speedbonder™ Structural Adhesive	36, 37
35940	Loctite® H8000™ Speedbonder™ Structural Adhesive	36, 37
36045	Loctite® Big Foot® Acrylic Pedestrian Grade	62, 65, 66
36160	Loctite® H8000™ Speedbonder™ Structural Adhesive	36, 37
36294	Loctite® 3972™ Light Cure Adhesive	161, 162
36295	Loctite® 3972™ Light Cure Adhesive	161, 162
36331	Loctite® 363™ Impruv® Light Cure Adhesive	22
36334	Loctite® Fixmaster® Magna-Crete™ Activator	71
36390	Loctite® 363™ Impruv® Light Cure Adhesive	22
36437	Loctite® 3941™ Light Cure Adhesive	161, 162
36476	Loctite® 3941™ Light Cure Adhesive	161, 162
36478	Loctite® 3943™ Light Cure Adhesive	161, 162
36480	Loctite® 3943™ Light Cure Adhesive	161, 162
36481	Loctite® 3942™ Light Cure Adhesive	161, 162
36483	Loctite® 3942™ Light Cure Adhesive	161, 162
36484	Loctite® 3921™ Light Cure Adhesive	161, 162
36485	Loctite® 3921™ Light Cure Adhesive	161, 162
36488	Loctite® 3924™ Light Cure Adhesive	161, 162
36489	Loctite® 3924™ Light Cure Adhesive	161, 162
36492	Loctite® 3926™ Light Cure Adhesive	161, 162
36493	Loctite® 3926™ Light Cure Adhesive	161, 162
36631	Loctite® 366™ Light Cure Adhesive	22
36766	Loctite® 3981™ Hysol® Epoxy Adhesive	41, 44, 165, 166
36767	Loctite® 3982™ Hysol® Epoxy Adhesive	46, 47, 165, 166
36768	Loctite® 3984™ Hysol® Epoxy Adhesive	36, 37, 165, 166
36780	Loctite® ViperLube® High Performance Synthetic Grease	91, 97, 99, 100
36781	Loctite® ViperLube® High Performance Synthetic Grease	91, 97, 99, 100
36782	Loctite® ViperLube® High Performance Synthetic Grease	91, 97, 99, 100
36783	Loctite® ViperLube® High Performance Synthetic Grease	91, 97, 99, 100
36784	Loctite® ViperLube® High Performance Synthetic Grease	91, 97, 99, 100
36786	Loctite® ViperLube® High Performance Synthetic Grease	91, 97, 99, 100
36792	Loctite® 3971™ Light Cure Adhesive	161, 162
36805	Loctite® 3971™ Light Cure Adhesive	161, 162
36923	Loctite® 5905™ Flange Sealant RTV Silicone	81, 86
37061	Loctite® ViperLube® High Performance Synthetic Grease	91, 97, 99, 100
37087	Loctite® QuickStix® 248™ Blue Threadlocker	142, 144, 147
37127	Loctite® QuickStix® 561™ PST® Pipe Sealant	150, 152, 154
37229	Loctite® QuickStix® C5-A® Copper Anti-Seize	92, 93, 95
37230	Loctite® QuickStix® Silver Grade Anti-Seize	92, 93, 95
37266	Loctite® 2760™ Threadlocker	148
37297	Loctite® 3981™ Hysol® Epoxy Adhesive	41, 44, 165, 166
37298	Loctite® 3982™ Hysol® Epoxy Adhesive	165, 166
37299	Loctite® 3984™ Hysol® Epoxy Adhesive	36, 37, 165, 166
37312	Loctite® Maximum Strength Headliner Adhesive	29, 30
37316	Loctite® Fixmaster® Marine Chocking	64, 70, 71

PRODUCT & ITEM NO.	PRODUCT DESCRIPTION	PAGE NUMBER
37388	Loctite® 220™ Threadlocker	142, 146, 148
37439	Loctite® 4306™ Flashcure® Light Cure Adhesives	8, 9, 19, 21, 163, 164
37441	Loctite® 4307™ Flashcure® Light Cure Adhesive	163
37442	Loctite® 4306™ Flashcure® Light Cure Adhesives	8, 9, 19, 21, 163, 164
37443	Loctite® 4307™ Flashcure® Light Cure Adhesive	163
37535	Loctite® Dielectric Grease	91, 97, 100
37684	Loctite® QuickStix® 248™ Blue Threadlocker	142, 144, 147
37685	Loctite® QuickStix® 268™ Threadlocker – High Strength	142, 144, 147
37686	Loctite® QuickStix® 268™ Threadlocker – High Strength	142, 144, 147
37708	Loctite® 4861™ Prism® Instant Adhesive	8, 9, 163, 164
37710	Loctite® ViperLube® High Performance Synthetic Grease	91, 97, 99, 100
37711	Loctite® 4861™ Prism® Instant Adhesive	8, 9, 163, 164
37719	Loctite® Fixmaster® Instant Belt Repair	117, 119, 120
37732	Loctite® 4851™ Prism® Instant Adhesive	8, 9, 163, 164
37733	Loctite® 4851™ Prism® Instant Adhesive	8, 9, 163, 164
38004	Loctite® 380™ Black Max® Instant Adhesive	7, 9
38050	Loctite® 380™ Black Max® Instant Adhesive	7, 9
38061	Loctite® 380™ Black Max® Instant Adhesive	7, 9
38181	Loctite® Silver Grade Anti-Seize	92, 93, 95
38203	Loctite® 382™ Tak Pak® Instant Adhesive	8, 10
38210	Loctite® 3944™ Light Cure Adhesive	162
38212	Loctite® 3944™ Light Cure Adhesive	162
38240	Loctite® 382™ Tak Pak® Instant Adhesive	8, 10
38261	Loctite® 382™ Tak Pak® Instant Adhesive	8, 10
38535	Loctite® 5905™ Flange Sealant RTV Silicone	81, 84, 86
38584	Loctite® C5-A® Copper Anti-Seize Lubricant	92, 93, 95
38588	Loctite® U-09LV™ Hysol® Urethane Adhesive	42
38589	Loctite® U-09LV™ Hysol® Urethane Adhesive	42
38590	Loctite® U-09LV™ Hysol® Urethane Adhesive	42
38760	Loctite® H8600™ Speedbonder™ Structural Adhesive	36, 37
38761	Loctite® H8600™ Speedbonder™ Structural Adhesive	36, 37
38762	Loctite® H8600™ Speedbonder™ Structural Adhesive	36, 37
38956	Loctite® Toolbox	157, 158
39088	Loctite® Fast Cure Mixer Cups	122
39148	Loctite® QuickStix® 668™ Retaining Compound, High Temperature	126, 127, 129
39152	Loctite® QuickStix® 548™ Gasket Eliminator® Flange Sealant	75, 77
39156	Loctite® QuickStix® 534™ Hi-Tack Gasket Dressing	75, 78
39186	Loctite® 220™ Threadlocker	142, 146, 148
39202	Loctite® QuickTite® Instant Adhesive	10
39205	Loctite® 392™ Structural Adhesive	31, 33
39210	Loctite® 5810A	83, 84
39211	Loctite® 5810A	83, 84
39222	Loctite® QuickStix® C5-A® Copper Anti-Seize	92, 93, 95
39223	Loctite® QuickStix® Silver Grade Anti-Seize	92, 93, 95
39246	Loctite® 5970™ Alcoxy Gasket Maker	82, 86
39250	Loctite® 392™ Structural Adhesive	31, 33
39275	Loctite® 392™ Structural Adhesive	31, 33
39280	Loctite® 392™ Structural Adhesive	31, 33
39317	Loctite® H4710™ Speedbonder™ Structural Adhesive	35, 37
39341	Loctite® ViperLube® Clear High Performance Synthetic Grease	91, 97, 99, 100
39342	Loctite® ViperLube® Clear High Performance Synthetic Grease	91, 97, 99, 100
39366	Loctite® Fixmaster® Concrete Repair Epoxy	64, 70, 71, 118, 121, 123
39395	Loctite® 3165™ Hysol® Epoxy Hardener	107
39397	Loctite® 3184™ Hysol® Polyurethane Hardener	107
39398	Loctite® 3184™ Hysol® Polyurethane Hardener	107
39401	Loctite® Clover® Silicon Carbide Grease Mix	102, 103, 104
39404	Loctite® Clover® Silicon Carbide Grease Mix	102, 103, 104
39406	Loctite® Clover® Silicon Carbide Pat Gel® Water Mix	103, 104
39413	Loctite® Clover® Silicon Carbide Grease Mix	102, 103, 104
39418	Loctite® Clover® Silicon Carbide Pat Gel® Water Mix	103, 104
39419	Loctite® Clover® Silicon Carbide Pat Gel® Water Mix	103, 104
39426	Loctite® Clover® Silicon Carbide Grease Mix	102, 103, 104
39428	Loctite® Clover® Silicon Carbide Grease Mix	102, 103, 104
39431	Loctite® Clover® Silicon Carbide Pat Gel® Water Mix	103, 104
39439	Loctite® Clover® Silicon Carbide Grease Mix	103, 104
39441	Loctite® Clover® Silicon Carbide Grease Mix	103, 104
39444	Loctite® Clover® Silicon Carbide Pat Gel® Water Mix	103, 104
39452	Loctite® Clover® Silicon Carbide Grease Mix	102, 103, 104
39455	Loctite® Clover® Silicon Carbide Grease Mix	102, 103, 104
39457	Loctite® Clover® Silicon Carbide Pat Gel® Water Mix	103, 104
39458	Loctite® Clover® Silicon Carbide Pat Gel® Water Mix	103, 104
39463	Loctite® Clover® Silicon Carbide Grease Mix	102, 103, 104
39465	Loctite® Clover® Silicon Carbide Grease Mix	102, 103, 104
39466	Loctite® Clover® Silicon Carbide Grease Mix	102, 103, 104
39468	Loctite® Clover® Silicon Carbide Pat Gel® Water Mix	103, 104
39473	Loctite® Clover® Silicon Carbide Grease Mix	102, 103, 104
39476	Loctite® Clover® Silicon Carbide Grease Mix	102, 103, 104
39478	Loctite® Clover® Silicon Carbide Pat Gel® Water Mix	103, 104
39479	Loctite® Clover® Silicon Carbide Pat Gel® Water Mix	103, 104
39483	Loctite® Clover® Silicon Carbide Grease Mix	102, 103, 104
39486	Loctite® Clover® Silicon Carbide Grease Mix	102, 103, 104
39488	Loctite® Clover® Silicon Carbide Pat Gel® Water Mix	103, 104
39499	Loctite® Clover® Silicon Carbide Grease Mix	103, 104
39504	Loctite® Clover® Silicon Carbide Pat Gel® Water Mix	103, 104
39510	Loctite® Clover® Silicon Carbide Grease Mix	102, 103, 104
39512	Loctite® Clover® Silicon Carbide Grease Mix	102, 103, 104
39515	Loctite® Clover® Silicon Carbide Pat Gel® Water Mix	103, 104
39523	Loctite® Clover® Silicon Carbide Grease Mix	102, 103, 104

PRODUCT & ITEM NO.	PRODUCT DESCRIPTION	PAGE NUMBER	PRODUCT & ITEM NO.	PRODUCT DESCRIPTION	PAGE NUMBER
39528	Loctite® Clover® Silicon Carbide Pat Gel® Water Mix	103, 104	40462	Loctite® 587™ Blue, High Performance RTV Silicone Gasket Maker	82, 84, 87
39536	Loctite® Clover® Silicon Carbide Grease Mix	102, 103, 104	40463	Loctite® 598™ Black, High Performance RTV Silicone Gasket Maker	82, 84, 87
39541	Loctite® Clover® Silicon Carbide Pat Gel® Water Mix	103, 104	40464	Loctite® Superflex® RTV Silicone Adhesive Sealant	83, 84, 87
39542	Loctite® Clover® Silicon Carbide Pat Gel® Water Mix	103, 104	40465	Loctite® Superflex® Red High Temp RTV Silicone Adhesive Sealant	83, 84, 87
39549	Loctite® Clover® Silicon Carbide Grease Mix	102, 103, 104	40466	Loctite® Superflex® RTV Silicone Adhesive Sealant	83, 84, 87
39551	Loctite® Clover® Silicon Carbide Grease Mix	102, 103, 104	40478	Loctite® Instant Gasket	82, 84, 87
39554	Loctite® Clover® Silicon Carbide Pat Gel® Water Mix	103, 104	40479	Loctite® Instant Gasket	82, 84, 87
39561	Loctite® Clover® Silicon Carbide Grease Mix	102, 103, 104	40481	Loctite® Superflex® RTV Silicone Adhesive Sealant	83, 84, 87
39566	Loctite® Clover® Silicon Carbide Pat Gel® Water Mix	103, 104	40482	Loctite® Superflex® RTV Silicone Adhesive Sealant – Blue	83, 84, 87
39574	Loctite® Clover® Silicon Carbide Grease Mix	102, 103, 104	40488	Loctite® O-Ring Making Kit – Metric	157, 158
39579	Loctite® Clover® Silicon Carbide Pat Gel® Water Mix	103, 104	40505	Loctite® 5699™ Grey, High Performance RTV Silicone Gasket Maker	81, 84, 86, 87
39587	Loctite® Clover® Silicon Carbide Grease Mix	102, 103, 104	40511	Loctite® 3145™ Hysol® Epoxy Resin	107
39589	Loctite® Clover® Silicon Carbide Grease Mix	102, 103, 104	40512	Loctite® 3145™ Hysol® Epoxy Resin	107
39590	Loctite® Clover® Silicon Carbide Grease Mix	102, 103, 104	40591	Loctite® Nordbak® Brushable Ceramic – Thin Mil	54
39592	Loctite® Clover® Silicon Carbide Pat Gel® Water Mix	103, 104	40594	Loctite® H8010™ Speedbonder™ Structural Adhesive	36, 37
39598	Loctite® Clover® Duplex Packaging Kit	103, 104	40604	Loctite® 406™ Prism® Instant Adhesive	7, 9
39633	Loctite® Fixmaster® Rapid Rubber Repair Static Mixers	119, 120	40640	Loctite® 406™ Prism® Instant Adhesive	7, 9
39636	Loctite® Flex™ Cleaner	120	40661	Loctite® 406™ Prism® Instant Adhesive	7, 9
39643	Loctite® C5-A® Copper Anti-Seize Lubricant	92, 93, 95	40724	Loctite® 5045™ Flange Sealant	81, 85
39711	Loctite® Clover® Silicon Carbide Reel Sharpening Mix	102, 103, 104	40760	Loctite® 3032™ Structural Adhesive	46, 48
39712	Loctite® Clover® Silicon Carbide Reel Sharpening Mix	102, 103, 104	40792	Loctite® 3355™ Light Cure Adhesive	19, 21
39715	Loctite® Clover® Silicon Carbide Reel Sharpening Mix	102, 103, 104	40793	Loctite® 3355™ Light Cure Adhesive	19, 21
39723	Loctite® Clover® Silicon Carbide Reel Sharpening Mix	102, 103, 104	40840	Loctite® 408™ Prism® Instant Adhesive	9
39893	Loctite® C-200® High Temperature Solid Film Lubricant	91, 98, 100	40861	Loctite® 408™ Prism® Instant Adhesive	9
39894	Loctite® C-200® High Temperature Solid Film Lubricant	91, 98, 100	40870	Loctite® 3985™ Hysol® Epoxy Adhesive	41, 44
39895	Loctite® Moly Dry Film Lubricant	91, 98, 100	40875	Loctite® H8600™ Speedbonder™ Structural Adhesive	36, 37
39896	Loctite® Moly Dry Film Lubricant	91, 98, 100	40888	Loctite® H8500™ Speedbonder™ Structural Adhesive	36, 37
39897	Loctite® Moly Dry Film Lubricant	91, 98, 100	40889	Loctite® H8500™ Speedbonder™ Structural Adhesive	36, 37
39901	Loctite® Zinc Anti-Seize	94, 95	40900	Loctite® Fixmaster® Superior Metal	118, 122, 123
39904	Loctite® Thread Seal Tape with PTFE	150, 153, 154	40904	Loctite® 409™ Super Bonder® Instant Adhesive	10
39915	Loctite® Big Foot® Zero V.O.C.	62, 65, 66	40945	Loctite® 409™ Super Bonder® Instant Adhesive	10
39916	Loctite® Urethane Sealant	83, 84	40969	Loctite® 5905™ Flange Sealant RTV Silicone	81, 86
39917	Loctite® Fixmaster® Fast Set Steel Putty	118, 122, 123	40974	Loctite® 409™ Super Bonder® Instant Adhesive	10
39944	Loctite® 3140™ Hysol® Epoxy Resin	107	40994	Loctite® 435™ Prism® Instant Adhesive	8, 9, 163, 164
39945	Loctite® 3140™ Hysol® Epoxy Resin	107	40995	Loctite® 435™ Prism® Instant Adhesive	8, 9, 163, 164
39947	Loctite® 3141™ Hysol® Epoxy Resin	107	40996	Loctite® 438™ Prism® Instant Adhesive	9
39948	Loctite® 3141™ Hysol® Epoxy Resin	107	40997	Loctite® 438™ Prism® Instant Adhesive	9
39950	Loctite® 3142™ Hysol® Epoxy Resin	107	41004	Loctite® 410™ Prism® Instant Adhesive	9
39958	Loctite® 3160™ Hysol® Epoxy Hardener	107	41005	Loctite® 435™ Prism® Instant Adhesive	8, 9, 163, 164
39960	Loctite® 3162™ Hysol® Epoxy Hardener	107	41006	Loctite® 438™ Prism® Instant Adhesive	9
39962	Loctite® 3162™ Hysol® Epoxy Hardener	107	41045	Loctite® 410™ Prism® Instant Adhesive	9
39964	Loctite® 3163™ Hysol® Epoxy Hardener	107	41061	Loctite® 410™ Prism® Instant Adhesive	9
39966	Loctite® 3163™ Hysol® Epoxy Hardener	107	41104	Loctite® 411™ Prism® Instant Adhesive	7, 9
39969	Loctite® 3164™ Hysol® Epoxy Hardener	107	41145	Loctite® 411™ Prism® Instant Adhesive	7, 9
39970	Loctite® 3164™ Hysol® Epoxy Hardener	107	41161	Loctite® 411™ Prism® Instant Adhesive	7, 9
39974	Loctite® 3165™ Hysol® Epoxy Hardener	107	41205	Loctite® QuickStix® Heavy Duty Anti-Seize	92, 93, 95
39984	Loctite® 3173™ Hysol® Polyurethane Resin	107	41254	Loctite® 431™ Prism® Instant Adhesive	7, 9, 163, 164
39985	Loctite® 3173™ Hysol® Polyurethane Resin	107	41255	Loctite® 431™ Prism® Instant Adhesive	7, 9, 163, 164
39986	Loctite® 3173™ Hysol® Polyurethane Resin	107	41256	Loctite® 431™ Prism® Instant Adhesive	7, 9, 163, 164
39995	Loctite® 3182™ Hysol® Polyurethane Hardener	107	41327	Loctite® 5600™ Silicone Sealant	81, 85
39996	Loctite® 3182™ Hysol® Polyurethane Hardener	107	41328	Loctite® 5604™ Silicone Sealant	81, 85
39997	Loctite® 3182™ Hysol® Polyurethane Hardener	107	41343	Loctite® Nordbak® Low Odor Wearing Compound	53, 57, 59
39998	Loctite® 3183™ Hysol® Polyurethane Hardener	107	41379	Loctite® 5572™ Adhesive	27, 28, 79, 80
39999	Loctite® 3183™ Hysol® Polyurethane Hardener	107	41380	Loctite® 5512™ Adhesive Sealant	27, 28, 79, 80
40086	Loctite® 5031™ Nuva-Sil® Silicone Potting Compound	19, 21, 111, 112	41386	Loctite® 5572™ Adhesive	27, 28, 79, 80
40087	Loctite® 5031™ Nuva-Sil® Silicone Potting Compound	19, 21, 111, 112	41387	Loctite® 5512™ Adhesive Sealant	27, 28, 79, 80
40088	Loctite® 5033™ Nuva-Sil® Silicone Adhesive Sealant	19, 21	41404	Loctite® 414™ Super Bonder® Instant Adhesive	10
40089	Loctite® 5033™ Nuva-Sil® Silicone Adhesive Sealant	19, 21	41450	Loctite® 414™ Super Bonder® Instant Adhesive	10
40104	Loctite® 401™ Prism® Instant Adhesive	7, 9	41461	Loctite® 414™ Super Bonder® Instant Adhesive	10
40140	Loctite® 401™ Prism® Instant Adhesive	7, 9	41550	Loctite® 415™ Super Bonder® Instant Adhesive	10
40161	Loctite® 401™ Prism® Instant Adhesive	7, 9	41561	Loctite® 415™ Super Bonder® Instant Adhesive	10
40270	Loctite® Fixmaster® Magna-Crete™	64, 71	41650	Loctite® 416™ Super Bonder® Instant Adhesive	10
40271	Loctite® Fixmaster® Magna-Crete™	64, 70, 71	41661	Loctite® 416™ Super Bonder® Instant Adhesive	10
40302	Loctite® Big Foot® Heavy Duty Pedestrian Grade	62, 65, 66	41732	Loctite® 5600™ Silicone Sealant	81, 85
40303	Loctite® Big Foot® Heavy Duty Pedestrian Grade	62, 65, 66	42050	Loctite® 420™ Super Bonder® Instant Adhesive	10
40304	Loctite® 403™ Prism® Instant Adhesive	7, 9	42061	Loctite® 420™ Super Bonder® Instant Adhesive	10
40319	Loctite® Fixmaster® High Solids Floor Coating Primer	63, 67, 68	42250	Loctite® 422™ Super Bonder® Instant Adhesive	10
40320	Loctite® Fixmaster® High Solids Floor Coating Primer	63, 67, 68	42261	Loctite® 422™ Super Bonder® Instant Adhesive	10
40321	Loctite® Fixmaster® High Solids Floor Coating Primer	63, 67, 68	42540	Loctite® 425™ Assure™ Instant Adhesive	145, 148
40332	Loctite® Fixmaster® Self-Leveling Flooring Epoxy	63, 67, 68	42561	Loctite® 425™ Assure™ Instant Adhesive	145, 148
40333	Loctite® Fixmaster® Self-Leveling Flooring Epoxy	63, 67, 68	43004	Loctite® 430™ Super Bonder® Instant Adhesive	10
40334	Loctite® Fixmaster® Self-Leveling Flooring Epoxy	63, 67, 68	43050	Loctite® 430™ Super Bonder® Instant Adhesive	10
40335	Loctite® Fixmaster® Self-Leveling Flooring Epoxy	63, 67, 68	43061	Loctite® 430™ Super Bonder® Instant Adhesive	10
40340	Loctite® 403™ Prism® Instant Adhesive	7, 9	45404	Loctite® 454™ Prism® Instant Adhesive	7, 9
40342	Loctite® Fixmaster® Self-Leveling Flooring Epoxy	63, 67, 68	45440	Loctite® 454™ Prism® Instant Adhesive	7, 9
40346	Loctite® Fixmaster® Crack Filler	64, 70, 71	45474	Loctite® 454™ Prism® Instant Adhesive	7, 9
40347	Loctite® Fixmaster® Flexible Joint Sealant	64, 70, 71	45478	Loctite® 454™ Prism® Instant Adhesive	7, 9
40348	Loctite® Fixmaster® Water-Based Epoxy Primer/Sealer	63, 67, 68	46004	Loctite® 460™ Prism® Instant Adhesive	9
40349	Loctite® Fixmaster® Water-Based Epoxy Primer/Sealer	63, 67, 68	46040	Loctite® 460™ Prism® Instant Adhesive	9
40351	Loctite® Fixmaster® Water-Based Epoxy Primer/Sealer	63, 67, 68	46061	Loctite® 460™ Prism® Instant Adhesive	9
40352	Loctite® Big Foot® Low Profile Pedestrian Grade	62, 65, 66	46548	Loctite® 404™ Quick Set™ Instant Adhesive	8, 10
40361	Loctite® 403™ Prism® Instant Adhesive	7, 9	46551	Loctite® 404™ Quick Set™ Instant Adhesive	8, 10
40404	Loctite® 5040™ RTV Silicone Potting Compound	111, 112	46561	Loctite® 404™ Quick Set™ Instant Adhesive	8, 10
40405	Loctite® 5040™ RTV Silicone Potting Compound	111, 112	48040	Loctite® 480™ Prism® Instant Adhesive	8, 9
40408	Loctite® 5045™ Flange Sealant	81, 85	48061	Loctite® 480™ Prism® Instant Adhesive	8, 9
40409	Loctite® 5045™ Flange Sealant	81, 85	49350	Loctite® 493™ Super Bonder® Instant Adhesive	10
40438	Loctite® 5039™ Nuva-Sil® Silicone Adhesive Sealant	19, 21, 82, 87	49361	Loctite® 493™ Super Bonder® Instant Adhesive	10
40439	Loctite® 5039™ Nuva-Sil® Silicone Adhesive Sealant	19, 21, 82, 87	49504	Loctite® 495™ Super Bonder® Instant Adhesive	10

INDEX BY ITEM NUMBER

PRODUCT & ITEM NO.	PRODUCT DESCRIPTION	PAGE NUMBER
49550	Loctite® 495™ Super Bonder® Instant Adhesive	10
49561	Loctite® 495™ Super Bonder® Instant Adhesive	10
49650	Loctite® 496™ Super Bonder® Instant Adhesive	10
49661	Loctite® 496™ Super Bonder® Instant Adhesive	10
49850	Loctite® 498™ Super Bonder® Instant Adhesive	8, 10
49861	Loctite® 498™ Super Bonder® Instant Adhesive	8, 10
49904	Loctite® 499™ Super Bonder® Instant Adhesive	10
49945	Loctite® 499™ Super Bonder® Instant Adhesive	10
49974	Loctite® 499™ Super Bonder® Instant Adhesive	10
50441	Loctite® 504™ Gasket Eliminator® Flange Sealant	75, 77
50480	Loctite® 504™ Gasket Eliminator® Flange Sealant	75, 77
50965	Loctite® 509™ Gasket Eliminator® Flange Sealant	75, 77
51001	Loctite® C5-A® Copper Anti-Seize Lubricant	92, 93, 95
51002	Loctite® C5-A® Copper Anti-Seize Lubricant	92, 93, 95
51003	Loctite® C5-A® Copper Anti-Seize Lubricant	92, 93, 95
51004	Loctite® C5-A® Copper Anti-Seize Lubricant	92, 93, 95
51005	Loctite® C5-A® Copper Anti-Seize Lubricant	92, 93, 95
51006	Loctite® C5-A® Copper Anti-Seize Lubricant	92, 93, 95
51007	Loctite® C5-A® Copper Anti-Seize Lubricant	92, 93, 95
51008	Loctite® C5-A® Copper Anti-Seize Lubricant	92, 93, 95
51009	Loctite® C5-A® Copper Anti-Seize Lubricant	92, 93, 95
51011	Loctite® C5-A® Copper Anti-Seize Lubricant	92, 93, 95
51031	Loctite® 510™ Gasket Eliminator® Flange Sealant	75, 77
51041	Loctite® 510™ Gasket Eliminator® Flange Sealant	75, 77
51048	Loctite® Moly Paste	92, 94, 95
51049	Loctite® Moly Paste	92, 94, 95
51050	Loctite® Moly Paste	92, 94, 95
51074	Loctite® 510™ Gasket Eliminator® Flange Sealant	75, 77
51084	Loctite® Graphite-50™ Anti-Seize	92, 94, 95
51094	Loctite® Moly-50™ Anti-Seize	92, 94, 95
51102	Loctite® Nickel Anti-Seize	92, 93, 95
51115	Loctite® N-1000™ High Purity Anti-Seize	92, 94, 95
51116	Loctite® N-1000™ High Purity Anti-Seize	92, 94, 95
51117	Loctite® N-1000™ High Purity Anti-Seize	92, 94, 95
51144	Loctite® C5-A® Copper Anti-Seize Lubricant	92, 93, 95
51145	Loctite® Moly Paste	92, 94, 95
51146	Loctite® C5-A® Copper Anti-Seize Lubricant	92, 93, 95
51147	Loctite® C5-A® Copper Anti-Seize Lubricant	92, 93, 95
51152	Loctite® Nickel Anti-Seize	92, 93, 95
51211	Loctite® Maxi-Coat™	52, 55, 56
51213	Loctite® Maxi-Coat™	52, 55, 56
51221	Loctite® Penetrating Oil	91, 98, 100
51242	Loctite® Extreme Pressure Grease	91, 97, 100
51243	Loctite® N-5000™ High Purity Anti-Seize	92, 94, 95
51245	Loctite® N-5000™ High Purity Anti-Seize	92, 94, 95
51246	Loctite® N-5000™ High Purity Anti-Seize	92, 94, 95
51252	Loctite® Food Grade Grease	91, 97, 100
51269	Loctite® N-5000™ High Purity Anti-Seize	92, 94, 95
51270	Loctite® N-7000™ High Purity Anti-Seize	92, 94, 95
51272	Loctite® N-7000™ High Purity Anti-Seize	92, 94, 95
51273	Loctite® N-7000™ High Purity Anti-Seize	92, 94, 95
51277	Loctite® C5-A® Copper Anti-Seize Lubricant	92, 93, 95
51286	Loctite® Nickel Anti-Seize	92, 93, 95
51299	Loctite® C5-A® Copper Anti-Seize Lubricant	92, 93, 95
51346	Loctite® N-5000™ High Purity Anti-Seize	92, 94, 95
51360	Loctite® Silicone Lubricant	91, 98, 100
51387	Loctite® Superflex® Non-Corrosive RTV Clear Silicone Adhesive Sealant	83, 84
51388	Loctite® Superflex® Non-Corrosive RTV Clear Silicone Adhesive Sealant	83, 84
51517	Loctite® 515™ Gasket Eliminator® Flange Sealant	75, 77
51531	Loctite® 515™ Gasket Eliminator® Flange Sealant	75, 77
51572	Loctite® High Performance N-5000™ High Purity Anti-Seize	92, 94, 95
51580	Loctite® 515™ Gasket Eliminator® Flange Sealant	75, 77
51605	Loctite® Heavy Duty Anti-Seize	92, 93, 95
51606	Loctite® Heavy Duty Anti-Seize	92, 93, 95
51607	Loctite® Heavy Duty Anti-Seize	92, 93, 95
51608	Loctite® Heavy Duty Anti-Seize	92, 93, 95
51609	Loctite® Heavy Duty Anti-Seize	92, 93, 95
51817	Loctite® 518™ Gasket Eliminator® Flange Sealant	75, 77
51831	Loctite® 518™ Gasket Eliminator® Flange Sealant	75, 77
51845	Loctite® 518™ Gasket Eliminator® Flange Sealant	75, 77
54505	Loctite® 545™ Thread Sealant	150, 152, 154
54531	Loctite® 545™ Thread Sealant	150, 152, 154
54541	Loctite® 545™ Thread Sealant	150, 152, 154
54941	Loctite® 549™ Instant Seal Plastic Gasket Thread Sealant	77
55441	Loctite® 554™ Thread Sealant	150, 152, 154
56507	Loctite® 565™ PST® Thread Sealant	150, 151, 153
56531	Loctite® 565™ PST® Thread Sealant	150, 151, 153
56541	Loctite® 565™ PST® Thread Sealant	150, 151, 153
56543	Loctite® 565™ PST® Thread Sealant	150, 151, 153
56566	Loctite® 565™ PST® Thread Sealant	150, 151, 153
56571	Loctite® 565™ PST® Thread Sealant	150, 151, 153
56707	Loctite® 567™ PST® Thread Sealant	150, 151, 153
56747	Loctite® 567™ PST® Thread Sealant	150, 151, 153
56765	Loctite® 567™ PST® Thread Sealant	150, 151, 153
56790	Loctite® 567™ PST® Thread Sealant	150, 151, 153
56841	Loctite® 568™ Flange Sealant, Plastic Gasket	77
56931	Loctite® 569™ Thread Sealant	150, 154
56941	Loctite® 569™ Thread Sealant	150, 154

PRODUCT & ITEM NO.	PRODUCT DESCRIPTION	PAGE NUMBER
57141	Loctite® 571™ Thread Sealant	150, 152, 154
57941	Loctite® 579™ Thread Sealant	150, 151, 153
58031	Loctite® 580™ PST® Thread Sealant	150, 152, 154
58730	Loctite® 587™ Blue, High Performance RTV Silicone Gasket Maker	82, 84
58775	Loctite® 587™ Blue, High Performance RTV Silicone Gasket Maker	82, 84
58791	Loctite® 587™ Blue, High Performance RTV Silicone Gasket Maker	82, 84
59214	Loctite® 592™ PST® Thread Sealant	150, 151, 153
59231	Loctite® 592™ PST® Thread Sealant	150, 151, 153
59241	Loctite® 592™ PST® Thread Sealant	150, 151, 153
59243	Loctite® 592™ PST® Thread Sealant	150, 151, 153
59330	Loctite® Superflex® RTV Silicone Adhesive Sealant	83, 84
59375	Loctite® Superflex® RTV Silicone Adhesive Sealant	83, 84
59430	Loctite® Superflex® RTV Silicone Adhesive Sealant	83, 84
59475	Loctite® Superflex® RTV Silicone Adhesive Sealant	83, 84
59530	Loctite® Superflex® RTV Silicone Adhesive Sealant	83, 84
59575	Loctite® Superflex® RTV Silicone Adhesive Sealant	83, 84
59630	Loctite® Superflex® Red High Temp RTV Silicone Adhesive Sealant	83, 84
59675	Loctite® Superflex® Red High Temp RTV Silicone Adhesive Sealant	83, 84
59830	Loctite® 598™ Black, High Performance RTV Silicone Gasket Maker	82, 84
59875	Loctite® 598™ Black, High Performance RTV Silicone Gasket Maker	82, 84
59891	Loctite® 598™ Black, High Performance RTV Silicone Gasket Maker	82, 84
60905	Loctite® 609™ Retaining Compound	126, 127, 129
60921	Loctite® 609™ Retaining Compound	126, 127, 129
60931	Loctite® 609™ Retaining Compound	126, 127, 129
60941	Loctite® 609™ Retaining Compound	126, 127, 129
60943	Loctite® 609™ Retaining Compound	126, 127, 129
62005	Loctite® 620™ Retaining Compound	126, 128, 129
62015	Loctite® 620™ Retaining Compound	126, 128, 129
62040	Loctite® 620™ Retaining Compound	126, 128, 129
62070	Loctite® 620™ Retaining Compound	126, 128, 129
62085	Loctite® 620™ Retaining Compound	126, 128, 129
63531	Loctite® 635™ Retaining Compound	126, 128, 130
63541	Loctite® 635™ Retaining Compound	126, 128, 130
64031	Loctite® 640™ Retaining Compound	126, 129
64041	Loctite® 640™ Retaining Compound	126, 129
66010	Loctite® 660™ Quick Metal® Retaining Compound	126, 128, 130
66040	Loctite® 660™ Quick Metal® Retaining Compound	126, 128, 130
67541	Loctite® 675™ Retaining Compound	126, 129
68005	Loctite® 680™ Retaining Compound	126, 128, 130
68015	Loctite® 680™ Retaining Compound	126, 128, 130
68035	Loctite® 680™ Retaining Compound	126, 128, 130
68060	Loctite® 680™ Retaining Compound	126, 128, 130
68090	Loctite® 680™ Retaining Compound	126, 128, 130
75430	Loctite® Extend® Rust Treatment	52, 55, 56
75448	Loctite® Extend® Rust Treatment	52, 55, 56
75465	Loctite® Extend® Rust Treatment	52, 55, 56
76732	Loctite® Silver Grade Anti-Seize	92, 93, 95
76759	Loctite® Silver Grade Anti-Seize	92, 93, 95
76764	Loctite® Silver Grade Anti-Seize	92, 93, 95
76775	Loctite® Silver Grade Anti-Seize	92, 93, 95
76820	Loctite® 768™ X-NMS Cleanup Solvent	133, 136, 137
76871	Loctite® 768™ X-NMS Cleanup Solvent	133, 136, 137
77124	Loctite® Nickel Anti-Seize	92, 93, 95
77164	Loctite® Nickel Anti-Seize	92, 93, 95
77175	Loctite® Nickel Anti-Seize	92, 93, 95
79040	Loctite® Chisel® Paint Stripper (Methylene Chloride)	133, 136, 137
80206	Loctite® Silver Grade Anti-Seize	92, 93, 95
80209	Loctite® Silver Grade Anti-Seize	92, 93, 95
80726	Loctite® No More Leaks™ Plastic Pipe Sealant	150, 154
80964	Loctite® Gasket Sealant 2 (Solvent-Based)	76, 78
81204	Loctite® Maintain® Lubricant Penetrant	91, 97, 100
81246	Loctite® Silicone Lubricant	91, 98, 100
81251	Loctite® Gear, Chain and Cable Lubricant	91, 98, 100
81252	Loctite® Solvo-Rust® Super Penetrating Oil	91, 98, 100
82039	Loctite® Cold Galvanizing Compound	52, 55, 56
82046	Loctite® 5920™ Copper, High Performance RTV Silicone Gasket Maker	82, 84, 86
82093	Loctite® Fixmaster® Underwater Repair Epoxy	118, 121, 123
82244	Loctite® Natural Blue® Biodegradable Cleaner & Degreaser	133, 135, 137
82249	Loctite® Natural Blue® Biodegradable Cleaner & Degreaser	133, 135, 137
82251	Loctite® Natural Blue® Biodegradable Cleaner & Degreaser	133, 135, 137
82253	Loctite® Natural Blue® Biodegradable Cleaner & Degreaser	133, 135, 137
82254	Loctite® Natural Blue® Biodegradable Cleaner & Degreaser	133, 135, 137
82255	Loctite® Natural Blue® Biodegradable Cleaner & Degreaser	133, 135, 137
82279	Loctite® Superflex® Red High Temp RTV Silicone Adhesive Sealant	83, 84
82481	Loctite® H.V.A.C. Blue Pipe Joint Compound	150, 153, 154
83000	Loctite® H3000™ Speedbonder™ Structural Adhesive	45, 48
83001	Loctite® H3000™ Speedbonder™ Structural Adhesive	45, 48
83006	Loctite® H3101™ Speedbonder™ Structural Adhesive	45, 48
83007	Loctite® H3101™ Speedbonder™ Structural Adhesive	45, 48
83014	Loctite® H3151™ Speedbonder™ Structural Adhesive	35, 37
83015	Loctite® H3151™ Speedbonder™ Structural Adhesive	35, 37
83019	Loctite® H3300™ Speedbonder™ Structural Adhesive	45, 48
83020	Loctite® H3300™ Speedbonder™ Structural Adhesive	45, 48
83022	Loctite® H3300™ Speedbonder™ Structural Adhesive	45, 48
83024	Loctite® H3300™ Speedbonder™ Structural Adhesive	45, 48
83025	Loctite® H4000™ Speedbonder™ Structural Adhesive	45, 47
83032	Loctite® H4100™ Speedbonder™ Structural Adhesive	45, 47
83038	Loctite® H4200™ Speedbonder™ Structural Adhesive	45, 47

PRODUCT & ITEM NO.	PRODUCT DESCRIPTION	PAGE NUMBER	PRODUCT & ITEM NO.	PRODUCT DESCRIPTION	PAGE NUMBER
83041	Loctite® H4500™ Speedbonder™ Structural Adhesive	35, 37	83400	Loctite® QuickPac™ Hysol® Hot Melt Adhesive	14, 16
83045	Loctite® H4800™ Speedbonder™ Structural Adhesive	45, 47	83404	Loctite® SuperPac™ Hysol® Hot Melt Adhesive	14, 16
83046	Loctite® H4800™ Speedbonder™ Structural Adhesive	45, 47	83405	Loctite® SuperPac™ Hysol® Hot Melt Adhesive	14, 16
83047	Loctite® H4800™ Speedbonder™ Structural Adhesive	45, 47	83675	Loctite® 7809FR™ Hysol® Hot Melt Adhesive	13, 15, 114
83062	Loctite® H6051™ Speedbonder™ Structural Adhesive	45, 47	83676	Loctite® 7809FR™ Hysol® Hot Melt Adhesive	13, 15, 114
83063	Loctite® H6051™ Speedbonder™ Structural Adhesive	45, 47	83677	Loctite® 0452™ Hysol® SprayPac™ Hot Melt Adhesive	13, 15
83065	Loctite® H6051™ Speedbonder™ Structural Adhesive	45, 47	94142	Loctite® Big Foot® Water-Based Primer/Sealer	61, 65, 66
83069	Loctite® 0151™ Hysol® Epoxy Adhesive	39, 43	95551	Loctite® Fixmaster® Magna-Crete™	64, 70, 71
83075	Loctite® 608™ Hysol® Epoxy Adhesive	39, 43	95555	Loctite® Fixmaster® Magna-Crete™	64, 70, 71
83082	Loctite® 608™ Hysol® Epoxy Adhesive	39, 43	95581	Loctite® Big Foot® Acrylic Primer	61, 65, 66
83083	Loctite® 608™ Hysol® Epoxy Adhesive	43	95591	Loctite® Big Foot® Acrylic Pedestrian Grade	62, 65, 66
83086	Loctite® 608™ Hysol® Epoxy Adhesive	39, 43	95724	Loctite® Fixmaster® 2000® Putty	118, 122, 123
83089	Loctite® D609™ Hysol® Epoxy Adhesive	43	96092	Loctite® Nordbak® Chemical Resistant Coating	52, 54, 55, 56, 58, 59
83094	Loctite® 615™ Hysol® Epoxy Adhesive	40, 44	96102	Loctite® Fixmaster® Marine Chocking	64, 70, 71
83095	Loctite® 615™ Hysol® Epoxy Adhesive	40, 44	96121	Loctite® Big Foot® Phenolic Roller Cores	65
83104	Loctite® 9340™ Hysol® Epoxy Adhesive	42, 44	96131	Loctite® Mixer Blades	65
83105	Loctite® 9340™ Hysol® Epoxy Adhesive	42, 44	96132	Loctite® Big Foot® Metal Primer	61, 65, 66
83113	Loctite® 9430™ Hysol® Epoxy Adhesive	40, 44	96153	Loctite® Big Foot® Bristle Roller Cores	65
83114	Loctite® 9430™ Hysol® Epoxy Adhesive	40, 44	96211	Loctite® Big Foot® Heavy Duty Pedestrian Grade	62, 65, 66
83126	Loctite® 9459™ Hysol® Epoxy Adhesive	42, 44	96221	Loctite® Big Foot® Vehicular Grade	62, 65, 66
83127	Loctite® 9460™ Hysol® Epoxy Adhesive	40, 44	96231	Loctite® Big Foot® Zero V.O.C.	62, 65, 66
83128	Loctite® 9460™ Hysol® Epoxy Adhesive	40, 44	96251	Loctite® Big Foot® Vehicular Grade	62, 65, 66
83129	Loctite® 9460™ Hysol® Epoxy Adhesive	40, 44	96255	Loctite® Big Foot® Vehicular Grade	62, 65, 66
83130	Loctite® 9460™ Hysol® Epoxy Adhesive	40, 44	96261	Loctite® Big Foot® Heavy Duty Pedestrian Grade	62, 65, 66
83131	Loctite® 9460™ Hysol® Epoxy Adhesive	40, 44	96265	Loctite® Big Foot® Heavy Duty Pedestrian Grade	62, 65, 66
83133	Loctite® 9460™ Hysol® Epoxy Adhesive	40, 44	96321	Loctite® Pipe Repair Kit	157, 158
83134	Loctite® 9460™ Hysol® Epoxy Adhesive	40, 44	96322	Loctite® Pipe Repair Kit	157, 158
83135	Loctite® 9462™ Hysol® Epoxy Adhesive	41, 44	96332	Loctite® Nordbak® Ultra-High Temperature Pneu-Wear	53, 57, 59
83142	Loctite® 9462™ Hysol® Epoxy Adhesive	41, 44	96363	Loctite® Nordbak® Fast Cure Pneu-Wear	53, 57, 59
83176	Loctite® 0151™ Hysol® Epoxy Adhesive	39, 43	96373	Loctite® Nordbak® Fast Cure Wearing Compound	53, 57, 59
83178	Loctite® 0151™ Hysol® Epoxy Adhesive	39, 43	96392	Loctite® Nordbak® Ultra-High Temperature Wearing Compound	53, 57, 59
83179	Loctite® 0151™ Hysol® Epoxy Adhesive	39, 43	96433	Loctite® Nordbak® High Temperature Brushable Ceramic	54, 58, 59
83180	Loctite® 0151™ Hysol® Epoxy Adhesive	43	96443	Loctite® Nordbak® Brushable Ceramic and Thin Mill Brushable Ceramic	54, 58, 59
83181	Loctite® 0151™ Hysol® Epoxy Adhesive	43	96495	Loctite® Fixmaster® High Performance Quartz	64, 69, 71
83216	Loctite® 9432NA™ Hysol® Epoxy Adhesive	35, 37	96583	Loctite® Fixmaster® Wet Surface Repair Putty	118, 122, 123
83217	Loctite® 9432NA™ Hysol® Epoxy Adhesive	35, 37	96604	Loctite® Fixmaster® Fast Set Steel Epoxy	122, 123
83239	Loctite® 232™ Hysol® Hot Melt Adhesive	14, 16	96675	Loctite® Fixmaster® Rapid Rubber Repair	117, 119, 120
83241	Loctite® 232™ Hysol® Hot Melt Adhesive	14, 16	96676	Loctite® Fixmaster® Rapid Rubber Repair	117, 119, 120
83245	Loctite® 232™ Hysol® Hot Melt Adhesive	14, 16	96677	Loctite® Fixmaster® Rapid Rubber Repair	117, 119, 120
83247	Loctite® 232™ Hysol® Hot Melt Adhesive	14, 16	97001	Loctite® Hand Pump, 250 ml	131, 155, 174
83252	Loctite® 236™ Hysol® Hot Melt Adhesive	16	97006	Loctite® Precision Syringe Dispensing System	12, 24, 170, 174
83257	Loctite® 0452™ Hysol® SprayPac™ Hot Melt Adhesive	13, 15	97042	Loctite® Dual Cartridge Pneumatic Applicator	34, 38, 50, 169, 174
83260	Loctite® 740™ Hysol® Hot Melt Adhesive	16	97101	Loctite® Digital Dispense Controller	11, 25, 173
83261	Loctite® 740™ Hysol® Hot Melt Adhesive	16	97111	Loctite® Handheld Applicator, Manual	23, 132, 156, 169, 174
83264	Loctite® 740™ Hysol® Hot Melt Adhesive	16	97112	Loctite® Handheld Applicator, Pneumatic	23, 132, 156, 169, 174
83266	Loctite® 1942™ Hysol® Hot Melt Adhesive	14, 16, 114	97113	Loctite® Stationary Applicator Valve	11, 132, 156, 175, 178
83267	Loctite® 1942™ Hysol® Hot Melt Adhesive	14, 16, 114	97114	Loctite® Stationary Applicator Valve	11, 132, 156, 175, 178
83269	Loctite® 1942™ Hysol® Hot Melt Adhesive	14, 16, 114	97116	Loctite® Handheld Applicator, Pneumatic	23, 132, 156, 169, 174
83271	Loctite® 1942™ Hysol® Hot Melt Adhesive	14, 16, 114	97123	Loctite® Single Channel Automatic Controller	173
83272	Loctite® 1942™ Hysol® Hot Melt Adhesive	14, 16, 114	97130	Loctite® Handheld Applicator, LV	11, 132, 156, 169, 174
83273	Loctite® 1942™ Hysol® Hot Melt Adhesive	14, 16, 114	97131	Loctite® Vari-Drop™ Applicator	11, 132, 156, 169, 174
83274	Loctite® 1942™ Hysol® Hot Melt Adhesive	14, 16, 114	97132	Loctite® Vari-Drop™ Applicator	11, 132, 156, 169, 174
83275	Loctite® 1942™ Hysol® Hot Melt Adhesive	14, 16, 114	97135	Loctite® Diaphragm Valve	132, 156, 175
83276	Loctite® 1942™ Hysol® Hot Melt Adhesive	14, 16, 114	97136	Loctite® Diaphragm Valve	132, 156, 175
83277	Loctite® 1942™ Hysol® Hot Melt Adhesive	14, 16, 114	97141	Loctite® Pinch Tube Valve	180
83278	Loctite® 4046™ Hysol® Hot Melt Adhesive	14, 16	97152	Loctite® Dual Channel Automatic Controller	11, 25
83279	Loctite® 4046™ Hysol® Hot Melt Adhesive	14, 16	97207	Loctite® Clear Syringe Starter Kit	184
83308	Loctite® 7460™ Hysol® SprayPac™ Polyshot Hot Melt Adhesive	13, 15	97208	Loctite® Syringe Air Line Adapter	184
83312	Loctite® 7500™ Hysol® SprayPac™ Polyshot Hot Melt Adhesive	13, 15	97210	Loctite® Ultraviolet Safety Glasses	168
83313	Loctite® 7500™ Hysol® SprayPac™ Polyshot Hot Melt Adhesive	13, 15	97215	Loctite® Cartridge-Syringe Adapter	183, 184
83325	Loctite® 7804™ Hysol® Hot Melt Adhesive	15	97216	Loctite® Syringe Starter Kit	184
83326	Loctite® 7804™ Hysol® Hot Melt Adhesive	15	97221	Loctite® Polyethylene Tapered Tips	183
83327	Loctite® 7804™ Hysol® Hot Melt Adhesive	15	97222	Loctite® Polyethylene Tapered Tips	183
83328	Loctite® 7804™ Hysol® Hot Melt Adhesive	15	97223	Loctite® Polyethylene Tapered Tips	183
83330	Loctite® 7804™ Hysol® Hot Melt Adhesive	15	97224	Loctite® Polyethylene Tapered Tips	183
83337	Loctite® 7811™ Hysol® Hot Melt Adhesive	13, 15, 114	97225	Loctite® Stainless Steel Tips	183
83338	Loctite® 7811™ Hysol® Hot Melt Adhesive	13, 15, 114	97226	Loctite® Stainless Steel Tips	183
83339	Loctite® 7811™ Hysol® Hot Melt Adhesive	13, 15, 114	97227	Loctite® Stainless Steel Tips	183
83340	Loctite® 7811™ Hysol® Hot Melt Adhesive	13, 15, 114	97228	Loctite® Stainless Steel Tips	183
83342	Loctite® 7901™ Hysol® Hot Melt Adhesive	13, 15, 114	97229	Loctite® Polypropylene Tips Helical Thread	183
83344	Loctite® 7901™ Hysol® Hot Melt Adhesive	13, 15, 114	97230	Loctite® Polypropylene Tips Helical Thread	183
83349	Loctite® 0430™ Hysol® SprayPac™ Polyshot Hot Melt Adhesive	13, 15	97231	Loctite® Polypropylene Tips Helical Thread	183
83354	Loctite® 0450™ Hysol® SprayPac™ Polyshot Hot Melt Adhesive	13	97232	Loctite® Polypropylene Tips Helical Thread	183
83356	Loctite® 0450™ Hysol® SprayPac™ Polyshot Hot Melt Adhesive	13, 15	97233	Loctite® Luer-Lok® Adapter Kit	183
83357	Loctite® 1X™ Hysol® Hot Melt Adhesive	14, 16	97244	Loctite® Clear Syringe Starter Kit	184
83358	Loctite® 1X™ Hysol® Hot Melt Adhesive	14, 16	97245	Loctite® Syringe Air Line Adapter	184
83360	Loctite® 1X™ Hysol® Hot Melt Adhesive	14, 16	97248	Loctite® Dispense Tip Caps	183
83365	Loctite® 1X™ Hysol® Hot Melt Adhesive	14, 16	97261	Loctite® Dispense Tip	183
83368	Loctite® 1X™ Hysol® Hot Melt Adhesive	14, 16	97262	Loctite® Dispense Tip	183
83369	Loctite® 3X™ Hysol® Polyshot Hot Melt Adhesive	14, 16	97263	Loctite® Black Syringe Barrel Kit for UV Adhesives	184
83370	Loctite® 3X™ Hysol® Polyshot Hot Melt Adhesive	14, 16	97264	Loctite® Black Syringe Barrel Kit for UV Adhesives	184
83373	Loctite® 740LV™ Hysol® Hot Melt Adhesive	16	97294	Loctite® Syringe Starter Kit	184
83390	Loctite® 7809FR™ Hysol® Hot Melt Adhesive	13, 15, 114	97412	Loctite® Fixmaster® Flex 80™ Liquid	117, 119, 120
83393	Loctite® CoolMelt™ Hysol® Hot Melt Adhesive	14, 16	97413	Loctite® Fixmaster® Flex 80™ Liquid	117, 119, 120
83394	Loctite® CoolMelt™ Hysol® Hot Melt Adhesive	14, 16	97422	Loctite® Fixmaster® Flex 80™ Putty	54, 58, 59, 117, 119, 120
83396	Loctite® QuickPac™ Hysol® Hot Melt Adhesive	14, 16	97423	Loctite® Fixmaster® Flex 80™ Putty	54, 58, 59, 117, 119, 120
83398	Loctite® QuickPac™ Hysol® Hot Melt Adhesive	14, 16	97443	Loctite® Fixmaster® Stainless Steel Putty	118, 122, 123
83399	Loctite® QuickPac™ Hysol® Hot Melt Adhesive	14, 16	97453	Loctite® Fixmaster® Aluminum Liquid	118, 122, 123

INDEX BY ITEM NUMBER

INDEX

Index by Item Number

PRODUCT & ITEM NO.	PRODUCT DESCRIPTION	PAGE NUMBER
97463	Loctite® Fixmaster® Aluminum Putty	118, 122, 123
97473	Loctite® Fixmaster® Superior Metal	118, 122, 123
97483	Loctite® Fixmaster® Steel Liquid	118, 122, 123
97484	Loctite® Fixmaster® Steel Liquid	118, 122, 123
97511	Loctite® Tri-Nozzle	183
97541	Loctite® Replacement Tube Inserts	180
97572	Loctite® Fixmaster® Marine Chocking	64, 70, 71
98003	Loctite® ZETA® 7415 UV Benchtop Conveyor	25, 167, 173
98004	Loctite® Electrodeless Lamp Assembly and Power Supply	25, 167, 173
98009	Loctite® Light Cure Dispense Valve	23, 132, 156, 169, 175, 178
98011	Loctite® Hysol™ Reactive Urethane Cartridge Dispenser	17, 18, 115, 116, 176
98012	Loctite® Cartridge Pre-Heater	18, 116
98013	Loctite® Cyanoacrylate Dispense Valve	11, 132, 156, 169, 175, 178
98022	Loctite® 300 ml Cartridge Pusher	12, 24, 78, 88, 113, 174
98026	Loctite® 30 ml Manual Syringe Applicator	23, 34, 49, 169, 174
98033	Loctite® Hysol™ 075 Hot Melt Dispenser	16, 17, 18, 115, 116, 176
98034	Loctite® Hysol™ 075-LT Hot Melt Dispenser	16, 17, 18, 115, 116, 176
98035	Loctite® Hysol™ 175 Hot Melt Dispenser	16, 17, 18, 115, 116, 176
98036	Loctite® Hysol™ 175-AIR Hot Melt Dispenser	16, 17, 18, 115, 116, 176
98037	Loctite® Hysol™ 175-SPRAY Hot Melt Dispenser	16, 17, 18, 115, 116, 176
98039	Loctite® ZETA® 7401 UV Chamber	25, 167, 173
98040	Loctite® Hysol™ 175-AIR-HT Hot Melt Dispenser	16, 17, 18, 115, 116, 176
98041	Loctite® Hysol™ 175-SPRAY-HT Hot Melt Dispenser	16, 17, 18, 115, 116, 176
98042	Loctite® Hot Melt Bench Mount Kit	17, 115, 176
98043	Loctite® Hot Melt Pneumatic Timer	17, 115, 176
98050	Loctite® Foot Pedal Dispenser	12, 24, 174
98060	Loctite® ZETA® 7420 Visible Light Flood System	25, 173
98061	Loctite® Polyethylene Tapered Tips	183
98062	Loctite® Polyethylene Tapered Tips	183
98063	Loctite® Polyethylene Tapered Tips	183
98064	Loctite® Polyethylene Tapered Tips	183
98065	Loctite® Stainless Steel Tips	183
98066	Loctite® Stainless Steel Tips	183
98067	Loctite® Stainless Steel Tips	183
98068	Loctite® Stainless Steel Tips	183
98069	Loctite® Polypropylene Tips Helical Thread	183
98070	Loctite® Polypropylene Tips Helical Thread	183
98071	Loctite® Polypropylene Tips Helical Thread	183
98074	Loctite® Dispense Tip	183
98079	Loctite® Shot Miser™ Valve Controller	11, 12, 24, 25, 132, 156, 173, 174
98080	Loctite® Stainless Steel Tips	183
98082	Loctite® Polypropylene Tips Helical Thread	183
98084	Loctite® Micro Needle Valve	23, 169, 175, 178
98085	Loctite® Shot Miser™ Dispense Valve	11, 12, 24, 132, 156, 174, 175
98089	Loctite® ZETA® 7011-V Dosimeter-Radiometer	26
98090	Loctite® Shot Miser™ Reservoir	12, 24, 131, 132, 155, 156, 173, 174
98100	Loctite® Stainless Steel Tips	183
98114	Loctite® Stainless Steel Tips Helical Thread	182
98115	Loctite® Stainless Steel Tips Helical Thread	182
98128	Loctite® Cartridge Dispense Tip	75, 76, 183
98163	Loctite® Stainless Steel Tips Helical Thread	182
98164	Loctite® Stainless Steel Tips Helical Thread	182
98165	Loctite® Stainless Steel Tips Helical Thread	182
98166	Loctite® Stainless Steel Tips Helical Thread	182
98167	Loctite® Stainless Steel Tips Helical Thread	182
98168	Loctite® Stainless Steel Tips Helical Thread	182
98169	Loctite® Stainless Steel Tips Helical Thread	182
98170	Loctite® Stainless Steel Tips Helical Thread	182
98171	Loctite® Stainless Steel Tips Helical Thread	182
98172	Loctite® Stainless Steel Tips Helical Thread	182
98173	Loctite® Stainless Steel Tips Helical Thread	182
98174	Loctite® Stainless Steel Tips Helical Thread	182
98175	Loctite® Stainless Steel Tips Helical Thread	182
98176	Loctite® Stainless Steel Tips Helical Thread	182
98177	Loctite® Stainless Steel Tips Helical Thread	182
98178	Loctite® Stainless Steel Tips Helical Thread	182
98179	Loctite® Stainless Steel Tips Helical Thread	182
98180	Loctite® Stainless Steel Tips Helical Thread	182
98181	Loctite® Cartridge-Tube Fitting Adapter	183
98193	Loctite® 30 ml Syringe Manual Plunger	34, 49, 174
98196	Loctite® Stainless Steel Tips Helical Thread	182
98197	Loctite® Stainless Steel Tips Helical Thread	182
98198	Loctite® Stainless Steel Tips Helical Thread	182
98199	Loctite® Stainless Steel Tips Helical Thread	182
98200	Loctite® Stainless Steel Tips Helical Thread	182
98201	Loctite® Stainless Steel Tips Helical Thread	182
98208	Loctite® Stainless Steel Tips	183
98209	Loctite® Stainless Steel Tips	183
98210	Loctite® Stainless Steel Tips	183
98211	Loctite® Stainless Steel Tips	183
98212	Loctite® Stainless Steel Tips	183
98213	Loctite® Stainless Steel Tips	183
98214	Loctite® Stainless Steel Tips	183
98215	Loctite® Stainless Steel Tips	183
98216	Loctite® Stainless Steel Tips Helical Thread	182
98217	Loctite® Stainless Steel Tips Helical Thread	182

PRODUCT & ITEM NO.	PRODUCT DESCRIPTION	PAGE NUMBER
98218	Loctite® Stainless Steel Tips Helical Thread	182
98219	Loctite® Stainless Steel Tips Helical Thread	182
98222	Loctite® Stainless Steel Tips Helical Thread	182
98223	Loctite® Stainless Steel Tips Helical Thread	182
98224	Loctite® Stainless Steel Tips Helical Thread	182
98225	Loctite® Stainless Steel Tips Helical Thread	182
98226	Loctite® Stainless Steel Tips Helical Thread	182
98227	Loctite® Stainless Steel Tips Helical Thread	182
98228	Loctite® Stainless Steel Tips Helical Thread	182
98229	Loctite® Stainless Steel Tips Helical Thread	182
98230	Loctite® Stainless Steel Tips Helical Thread	182
98231	Loctite® Stainless Steel Tips Helical Thread	182
98232	Loctite® Stainless Steel Tips Helical Thread	182
98233	Loctite® Stainless Steel Tips Helical Thread	182
98234	Loctite® Stainless Steel Tips Helical Thread	182
98235	Loctite® Stainless Steel Tips Helical Thread	182
98236	Loctite® Stainless Steel Tips Helical Thread	182
98237	Loctite® Stainless Steel Tips Helical Thread	182
98238	Loctite® Stainless Steel Tips Helical Thread	182
98239	Loctite® Stainless Steel Tips Helical Thread	182
98240	Loctite® Stainless Steel Tips Helical Thread	182
98241	Loctite® Stainless Steel Tips Helical Thread	182
98242	Loctite® Stainless Steel Tips Helical Thread	182
98243	Loctite® Stainless Steel Tips Helical Thread	182
98244	Loctite® Stainless Steel Tips Helical Thread	182
98245	Loctite® Stainless Steel Tips Helical Thread	182
98246	Loctite® Stainless Steel Tips Helical Thread	182
98247	Loctite® Stainless Steel Tips Helical Thread	182
98248	Loctite® Stainless Steel Tips Helical Thread	182
98249	Loctite® Stainless Steel Tips Helical Thread	182
98250	Loctite® Stainless Steel Tips Helical Thread	182
98251	Loctite® Stainless Steel Tips Helical Thread	182
98252	Loctite® Stainless Steel Tips Helical Thread	182
98253	Loctite® Stainless Steel Tips Helical Thread	182
98254	Loctite® Stainless Steel Tips Helical Thread	182
98255	Loctite® Stainless Steel Tips Helical Thread	182
98256	Loctite® Stainless Steel Tips Helical Thread	182
98257	Loctite® Stainless Steel Tips Helical Thread	182
98258	Loctite® Stainless Steel Tips Helical Thread	182
98259	Loctite® Stainless Steel Tips Helical Thread	182
98260	Loctite® Stainless Steel Tips Helical Thread	182
98261	Loctite® Stainless Steel Tips Helical Thread	182
98262	Loctite® Stainless Steel Tips Helical Thread	182
98263	Loctite® Stainless Steel Tips Helical Thread	182
98264	Loctite® Stainless Steel Tips Helical Thread	182
98265	Loctite® Stainless Steel Tips Helical Thread	182
98266	Loctite® Stainless Steel Tips Helical Thread	182
98267	Loctite® Stainless Steel Tips Helical Thread	182
98268	Loctite® Stainless Steel Tips Helical Thread	182
98269	Loctite® Stainless Steel Tips Helical Thread	182
98270	Loctite® Stainless Steel Tips Helical Thread	182
98271	Loctite® Stainless Steel Tips Helical Thread	182
98272	Loctite® Polyethylene Tapered Tips	183
98273	Loctite® Polyethylene Tapered Tips	183
98283A	Loctite® D-Series Benchtop Robot Station	177
98291A	Loctite® D-Series 200 Benchtop Robot Station	177
98299A	Loctite® D-Series 200 Benchtop Robot Station	177
98314	Loctite® Clear Syringe Starter Kit	184
98315	Loctite® Black Syringe Barrel Kit	184
98316	Loctite® 30 ml Syringe Mounting Bracket Kit	178
98318	Loctite® 300 ml Cartridge Mounting Bracket Kit	178
98319A	Loctite® 300 ml Pneumatic Cartridge Dispensing Retainer	12, 24, 49, 78, 88, 113, 174
98320	Loctite® Syringe Adapter	178
98321	Loctite® Syringe Adapter	178
98322	Loctite® Syringe Adapter	178
98325	Loctite® 360-Degree Rotation Kit	178
98326	Loctite® Valve Mounting Bracket Kit	178
98327	Loctite® Valve Mounting Bracket Kit	178
98328	Loctite® Mounting Rails for 3-Axis Benchtop Robots and Dispense Stations	178
98329	Loctite® Mounting Rails for 3-Axis Benchtop Robots and Dispense Stations	178
98330	Loctite® Mounting Rails for 3-Axis Benchtop Robots and Dispense Stations	178
98332	Loctite® Tip Locator Bracket	178
98333	Loctite® Tip Locator Bracket	178
98334	Loctite® Tip Locator Bracket	178
98335	Loctite® Tip Locator Bracket	178
98336	Loctite® Mounting Adapter for 4-Axis Robots	178
98337	Loctite® Mounting Plate for 3-Axis SCARA Robot	178
98340	Loctite® Mounting Kit for 3-Axis SCARA Robots	178
98341	Loctite® Mounting Kit for 3-Axis SCARA Robots	178
98342	Loctite® Mounting Kit for 3-Axis SCARA Robots	178
98343	Loctite® Mounting Kit for 3-Axis SCARA Robots	178
98345	Loctite® Soft Squeeze Bottle	11, 131, 155, 174
98346	Loctite® Soft Squeeze Bottle	11, 131, 155, 174
98347	Loctite® Soft Squeeze Bottle	11, 131, 155, 174
98357	Loctite® Z Height Adjustment Plate for 3-Axis Benchtop Robot	178
98364	Loctite® Mix Nozzle	185
98367	Loctite® Snap Tip Mix Nozzle	186
98371	Loctite® Cartridge-Needle Adapter	183

PRODUCT & ITEM NO.	PRODUCT DESCRIPTION	PAGE NUMBER
98372	Loctite® Nordbak® High Temperature Pneu-Wear	53, 57, 59
98373	Loctite® Square Mix Nozzle	185
98374	Loctite® Square Mix Nozzle	185
98377	Loctite® Posi-Link™ Contoller	174, 179, 180
98379	Loctite® Posi-Link™ 10-50 Actuator	180
98380	Loctite® Posi-Link™ 200-400 Actuator	180
98382	Loctite® Nordbak® Pneu-Wear	53, 57, 59
98383	Loctite® Nordbak® Pneu-Wear	53, 57, 59
98385	Loctite® Polyethylene Tapered Tips Helical Thread and UV Light Block Additive	182
98386	Loctite® Polyethylene Tapered Tips Helical Thread and UV Light Block Additive	182
98387	Loctite® Polyethylene Tapered Tips Helical Thread and UV Light Block Additive	182
98388	Loctite® Polyethylene Tapered Tips Helical Thread and UV Light Block Additive	182
98389	Loctite® Polyethylene Tapered Tips Helical Thread and UV Light Block Additive	182
98390	Loctite® Polyethylene Tapered Tips Helical Thread and UV Light Block Additive	182
98391	Loctite® Polyethylene Tapered Tips Helical Thread and UV Light Block Additive	182
98392	Loctite® Polyethylene Tapered Tips Helical Thread and UV Light Block Additive	182
98393	Loctite® Polyethylene Tapered Tips Helical Thread and UV Light Block Additive	182
98394	Loctite® Polyethylene Tapered Tips Helical Thread and UV Light Block Additive	182
98396	Loctite® Stainless Steel Tips Helical Thread	182
98397	Loctite® Stainless Steel Tips Helical Thread	182
98398	Loctite® Stainless Steel Tips Helical Thread	182
98399	Loctite® Stainless Steel Tips Helical Thread	182
98400	Loctite® Stainless Steel Tips Helical Thread	182
98401	Loctite® Stainless Steel Tips Helical Thread	182
98402	Loctite® Stainless Steel Tips Helical Thread	182
98403	Loctite® Stainless Steel Tips Helical Thread	182
98404	Loctite® Stainless Steel Tips Helical Thread	182
98405	Loctite® Stainless Steel Tips Helical Thread	182
98406	Loctite® Poppet Valve Mounting Bracket Kit	178
98407	Loctite® Tip Locator Bracket	178
98408	Loctite® Mounting Kit for 3-Axis SCARA Robots	178
98409	Loctite® Stepped Tip Mix Nozzle	186
98413	Loctite® ZETA® 7411-S UV Flood System	25, 167, 173
98414	Loctite® 50 ml Hand Pump	131, 155, 174
98415	Loctite® Caulking Gun Conversion Kit	34, 38, 50, 174
98416	Loctite® Syringe Starter Kit	184
98424	Loctite® Stainless Steel Tips Helical Thread	182
98425	Loctite® Stainless Steel Tips Helical Thread	182
98430	Loctite® Mix Nozzle	186
98439	Loctite® Needle Variety Kit	183
98440	Loctite® LED 7700 On/Off Foot Switch	26
98441	Loctite® Micro Needle Valve Mounting Bracket Kit	178
98444	Loctite® Square Mix Nozzle	185
98445	Loctite® Light Cure Acrylic Adhesive Dispensing System	170, 174
98446	Loctite® Roller Assembly	183
98447	Loctite® Replacement Roller	183
98448	Loctite® Roller Assembly	183
98449	Loctite® Replacement Roller	183
98452	Loctite® Ultraviolet Safety Glasses	168
98453	Loctite® ZETA® Dosimeter Adapter	26
98454	Loctite® Mix Nozzle	50, 185
98455	Loctite® Mix Nozzle	123, 185
98456	Loctite® Mix Nozzle	185
98457	Loctite® Mix Nozzle	185
98458	Loctite® Luer-Lok® Nozzle Adapter	186
98460	Loctite® Stepped Tip Mix Nozzle	186
98461	Loctite® Mix Nozzle	50, 186
98463	Loctite® Mix Nozzle	50
98464	Loctite® Mix Nozzle	185
98466	Loctite® Caulking Gun Conversion Kit	34, 38, 50, 174
98469	Loctite® Snap Tip Mix Nozzle	186
98471	Loctite® Flex™ Metal Primer	120
98472	Loctite® 50 ml Dual Cartridge Manual Applicator	34, 38, 50, 122, 123, 174
98473	Loctite® Mix Nozzle	50, 185
98474	Loctite® Mix Nozzle	50, 185
98479	Loctite® Syringe Barrel and Piston, Clear	184
98481	Loctite® Syringe Barrel and Piston, Black	184
98483	Loctite® Syringe Barrel and Piston, Clear	184
98485	Loctite® Syringe Barrel and Piston, Black	184
98487	Loctite® Syringe Barrel and Piston, Clear	184
98489	Loctite® Syringe Barrel and Piston, Black	184
98491	Loctite® Syringe Barrel and Piston, Clear	184
98493	Loctite® Syringe Barrel and Piston, Black	184
98496	Loctite® Syringe Barrel and Piston, Clear	184
98497	Loctite® Syringe Barrel and Piston, Black	184
98499	Loctite® Dispense Tip Caps	183
98501	Loctite® Applicator Holder	184
98520	Loctite® Spray Valve	139, 175, 178
98522	Loctite® LED Holder	26
98544	Loctite® Hysol™ 050 Hot Melt Applicator	16, 18, 116
98545	Loctite® Hysol™ 050-HT Hot Melt Dispenser	16, 17, 18, 115, 116, 176
98548	Loctite® Benchtop Peristaltic Dispenser	12, 24, 132, 156, 170, 174
98595	Loctite® 7703 LED Light Source	26, 168, 173
98602	Loctite® 500 Benchtop Robot Station	177
98606	Loctite® 500 Benchtop Robot Station	177
98610	Loctite® NPT Dispense Nozzle	183
98611	Loctite® Stainless Steel Tips Helical Thread	182
98612	Loctite® Stainless Steel Tips Helical Thread	182

PRODUCT & ITEM NO.	PRODUCT DESCRIPTION	PAGE NUMBER
98622	Loctite® Mix Nozzle	185
98623	Loctite® Mix Nozzle	185
98624	Loctite® Stainless Steel Tips Helical Thread	182
98625	Loctite® Stainless Steel Tips Helical Thread	182
98626	Loctite® Stainless Steel Tips Helical Thread	182
98627	Loctite® Stainless Steel Tips Helical Thread	182
98628	Loctite® Stainless Steel Tips Helical Thread	182
98629	Loctite® Stainless Steel Tips Helical Thread	182
98632	Loctite® Square Mix Nozzle	185
98641	Loctite® Posi-Link™ Dual Cartridge Nests	180
98642	Loctite® Posi-Link™ Dual Cartridge Nests	180
98646	Loctite® Universal Syringe Bracket for Posi-Link™	178
98647	Loctite® 50 ml Dual Cartridge Bracket for Posi-Link™	178
98652	Loctite® Light-Blocking Shield for dispense Tips	183
98653	Loctite® Square Mix Nozzle	185
98656	Loctite® Syringe Air Line Adapter	184
98657	Loctite® Syringe Air Line Adapter	184
98658	Loctite® 1 1/4" Polyethylene Tapered Tips Helical Thread and UV Light Block Additive	182
98659	Loctite® 1 1/4" Polyethylene Tapered Tips Helical Thread and UV Light Block Additive	182
98660	Loctite® 1 1/4" Polyethylene Tapered Tips Helical Thread and UV Light Block Additive	182
98662	Loctite® Posi-Link™ Dual Cartridge Nests	180
98663	Loctite® Posi-Link™ Dual Cartridge Nests	180
98664	Loctite® Posi-Link™ Dual Cartridge Nests	180
98667	Loctite® Square Mix Nozzle	185
98668	Loctite® Square Mix Nozzle	185
98669	Loctite® Handheld LED Mounting Bracket	178
98671	Loctite® Solenoid Valve	180
98672	Loctite® Mix Nozzle	186
98687	Loctite® Nozzle Adapter/Check Valve	18, 116
98693	Loctite® Fixmaster® Flex™ Conveyor Belt Repair Kit	117, 119, 120
98732	Loctite® Nordbak® Brushable Ceramic and Thin Mill Brushable Ceramic	54, 58, 59
98733	Loctite® Nordbak® Brushable Ceramic and Thin Mill Brushable Ceramic	54, 58, 59
98742	Loctite® Fixmaster® Wear-Resistant Putty	53, 58, 59, 122, 123
98743	Loctite® Fixmaster® Wear-Resistant Putty	53, 58, 59, 122, 123
98853	Loctite® Fixmaster® Metal Magic Steel™	118, 121, 123
98892	Loctite® Nordbak® Castable Wearing Compound	54, 58, 59
99112	Loctite® Nordbak® High Temperature Wearing Compound	53, 57, 59
99361	Loctite® Fixmaster® Floor Fill	64, 69, 71
99365	Loctite® Fixmaster® Floor Fill	64, 69, 71
99545	Loctite® Fixmaster® Deep Pour Grout	64, 69, 71
99626	Loctite® Etching Agent	120
99912	Loctite® Fixmaster® Steel Putty	118, 122, 123
99913	Loctite® Fixmaster® Steel Putty	118, 122, 123
99914	Loctite® Fixmaster® Steel Putty	118, 122, 123
142245	Loctite® Primer Applicators	90
149361	Loctite® Cutting Wire for Glass Removal	90
272793	Loctite® Dispense Tip	183
395397	Loctite® Cartridge Opener	90
419115	Loctite® Nozzle Adapter/Check Valve	18, 116
805741	Loctite® UVALOC 1000 UV Cure Chamber	25, 167, 173
827608	Loctite® H8500™ Speedbonder™ Structural Adhesive	36, 37
830703	Loctite® Stainless Steel Tips Helical Thread	182
830704	Loctite® Stainless Steel Tips Helical Thread	182
831304	Loctite® Fixmaster® Magna-Crete™	64, 70, 71
883976	Loctite® Digital Syringe Dispensing System	12, 24, 170, 174
883979	Loctite® 7703-HD LED Light Source	26, 168, 173
901426	Loctite® E-04SS™ Epoxy Adhesive	45, 48
901428	Loctite® E-04SS™ Epoxy Adhesive	45, 48
902242	Loctite® E-04SS™ Epoxy Adhesive	45, 48
913475	Loctite® H4720™ Speedbonder™ Structural Adhesive	35, 37
916050	Loctite® 1-Hole Nozzle	18, 116
916282	Loctite® Hysol™ 050A Hot Melt Dispenser	17, 18, 115, 116, 176
918088	Loctite® Mix Nozzle	185
922089	Loctite® 5600™ Silicone Sealant	81, 85
922122	Loctite® 5600™ Silicone Sealant	81, 85
922128	Loctite® 5600™ Silicone Sealant	81, 85
922129	Loctite® 5600™ Silicone Sealant	81, 85
922129	Loctite® 5604™ Silicone Sealant	81, 85
922544	Loctite® 5600™ Silicone Sealant	81, 85
922546	Loctite® 5600™ Silicone Sealant	81, 85
924107	Loctite® 5600™ Silicone Sealant	81, 85
924107	Loctite® 5604™ Silicone Sealant	81, 85
930705	Loctite® Mix Nozzle	185
960304	Loctite® Powerline II 300 ml Dispenser	90
960356	Loctite® LED Cure Timer	26
960973	Loctite® 3034™ Structural Adhesive	46, 48
970655	Loctite® Luer-Lok® Nozzle Adapter	186
971031	Loctite® Indigo® 7418 Visible Flood System	25, 167, 173
976786	Loctite® Fixmaster® Magna-Crete™	64, 70, 71
980160	Loctite® High Intensity Ultraviolet Sources	25, 167, 173
982644	Loctite® Cartridge Adapter	183
982719	Loctite® Bond-A-Matic® 3000 Reservoir	12, 24, 132, 156, 170, 174
982720	Loctite® Bond-A-Matic® 3000 Reservoir	12, 24, 131, 155, 170, 173
982722	Loctite® Bond-A-Matic® 3000 Reservoir	12, 24, 132, 156, 170, 174
982723	Loctite® Bond-A-Matic® 3000 Reservoir	12, 24, 131, 155, 170, 173
982726	Loctite® Bond-A-Matic® 3000 Reservoir	12, 24, 131, 155, 170, 173
982727	Loctite® Bond-A-Matic® 3000 Reservoir	12, 24, 131, 155, 170, 173
982880	Loctite® 4 Liter Gravity Feed Reservoir	131, 155, 173

INDEX BY ITEM NUMBER

INDEX

Index by Item Number

PRODUCT & ITEM NO.	PRODUCT DESCRIPTION	PAGE NUMBER
983330	Loctite® Positive Displacement Pump	132, 156, 175
983436	Loctite® Dual Cartridge Manual Applicator	34, 38, 50, 174
983437	Loctite® Dual Cartridge Pneumatic Applicator	34, 38, 50, 174
983438	Loctite® Dual Cartridge Manual Applicator	34, 38, 50, 174
983439	Loctite® Dual Cartridge Pneumatic Applicator	34, 38, 50, 174
983509	Loctite® Mix Nozzle	185
984261	Loctite® Standard Adapter for 300 ml Cartridge	18, 116
984262	Loctite® Standard 1-Hole Nozzle	18, 116
984263	Loctite® Adapter/Check Valve for Specialty Nozzles	18, 116
984264	Loctite® Needle Jet Nozzle	18, 116
984265	Loctite® Diagonal Extension Nozzle	18, 116
984266	Loctite® Flat Spreader Nozzle	18
984267	Loctite® 2-Hole Nozzle	18, 116
984268	Loctite® 3-Hole Nozzle	18, 116
984272	Loctite® Injection Needle Nozzle	18, 116
984650	Loctite® Air Line Filter for Syringe Dispensing	184
984832	Loctite® Tube Fitting	183
984833	Loctite® Tube Fitting	183
984999	Loctite® Standard 1-Hole Nozzle	18, 116
985001	Loctite® Spreader Nozzle	18, 116
985002	Loctite® Pencil Point Nozzle	18, 116
985003	Loctite® Precision Nozzle	18, 116
985004	Loctite® Extension Nozzle	18, 116
985005	Loctite® Silicone Rubber Safety Cap	18, 116
985087	Loctite® Heavy Duty Metal Stand for Benchtop or Wall Mounting	18, 116
985110	Loctite® 2-Hole Nozzle	18, 116
985111	Loctite® 3-Hole Nozzle	18, 116
985112	Loctite® Diagonal Extension Nozzle	18, 116
985113	Loctite® Needle Extension Nozzle	18, 116
985114	Loctite® Spreader Extension Nozzle	18, 116
985115	Loctite® L-Nozzle	18, 116
985116	Loctite® T-Nozzle	18, 116
985122	Loctite® Standard Medium Spray Nozzle	18, 116
985211	Loctite® Narrow Spray Nozzle	18, 116
985216	Loctite® Ultra-Wide Spray Nozzle	18, 116
985225	Loctite® 1-Hole Nozzle	18, 116
985243	Loctite® Tool Hanger/Balancer	18, 116
985246	Loctite® Dual Cartridge Manual Applicator	34, 38, 50, 174
985249	Loctite® Dual Cartridge Pneumatic Applicator	34, 38, 50, 174
985397	Loctite® Air Line Filter, Regulator Gauge	18, 116
986000	Loctite® Pump-A-Bead™ II Dispenser	78, 174
986300	Loctite® Poppet Valve	78, 132, 156, 175, 178
988107	Loctite® Nozzle Adapter/Check Valve	18, 116
988108	Loctite® 1-Hole Nozzle	18, 116
989516	Loctite® Mix Nozzle	185
989518	Loctite® Mix Nozzle	185
989763	Loctite® 200 Series Light Curtain Guarding System	178
989771	Loctite® 300 Series Light Curtain Guarding System	178
989777	Loctite® 400/500 Series Light Curtain Guarding System	178
989783	Loctite® 200 Series Workbench	178
989784	Loctite® 300 Series Workbench	178
989785	Loctite® 400/500 Series Workbench	178
989787	Loctite® 200 Series Slide Door Guarding System	178
989788	Loctite® 300 Series Slide Door Guarding System	178
989789	Loctite® 400/500 Series Slide Door Guarding System	178
989852	Loctite® SCARA Light Curtain Guarding System	178
989860	Loctite® SCARA Series Workbench	178
996453	Loctite® H8000™ Speedbonder™ Structural Adhesive	36, 37
996456	Loctite® Freeze & Release™	91, 98, 100
996512	Loctite® H4500™ Speedbonder™ Structural Adhesive	35, 37
996513	Loctite® H8510™ Speedbonder™ Structural Adhesive	36, 37
996514	Loctite® H8500™ Speedbonder™ Structural Adhesive	36, 37
996515	Loctite® H4800™ Speedbonder™ Structural Adhesive	45, 47
997367	Loctite® Nordbak® Brushable Ceramic and Thin Mill Brushable Ceramic	54, 58, 59
997369	Loctite® Nordbak® High Temperature Brushable Ceramic	54, 58, 59
998390	Loctite® Vari-Drop™ Applicator Brushes	183
998400	Loctite® Dial-A-Seal® Applicator	155, 174
1003327	Loctite® LED-HD Timer Handle	26
1008338	S440 SCARA-N Robot Station	177
1008351	S440 SCARA-N Robot Station	177
1010320	Loctite® 5240™ Nuva-Sil® Medical Device Sealant	20, 21, 111, 112, 165, 166
1010341	Loctite® 5240™ Nuva-Sil® Medical Device Sealant	20, 21, 111, 112, 165, 166
1010343	Loctite® 5240™ Nuva-Sil® Medical Device Sealant	20, 21, 111, 112, 165, 166
1012500	Loctite® Fixmaster® Magna-Crete™	64, 70, 71
1022006	Loctite® Digital Multifunctional Controller	11, 25, 173
1032026	Loctite® Mix Nozzle	185
1032028	Loctite® Mix Nozzle	185
1034026	Loctite® 50 ml Dual Cartridge Manual Applicator	34, 38, 50, 174
1034030	Loctite® LED Mounting Bracket Kit	178
1034575	Loctite® Mix Nozzle	185
1041620	Loctite® Durapump™ Pneumatic Meter Mix System	181
1041635	Loctite® Durapump™ Programmable Meter Mix System	181
1041636	Loctite® Durapump™ Pneumatic Meter Mix System	181
1041637	Loctite® Durapump™ Pneumatic Meter Mix System	175, 181
1041638	Loctite® Durapump™ Programmable Meter Mix System	175, 181
1041639	Loctite® Durapump™ Programmable Meter Mix System	175, 181
1041641	Loctite® Durapump™ Pneumatic Meter Mix System	175, 181
1041643	Loctite® Durapump™ Pneumatic Meter Mix System	175, 181

PRODUCT & ITEM NO.	PRODUCT DESCRIPTION	PAGE NUMBER
1041644	Loctite® Durapump™ Programmable Meter Mix System	175, 181
1041647	Loctite® Durapump™ Pneumatic Meter Mix System	181
1041648	Loctite® Durapump™ Pneumatic Meter Mix System	175, 181
1041649	Loctite® Durapump™ Programmable Meter Mix System	175, 181
1044246	Loctite® Aero Nozzle	183
1044247	Loctite® Cartridge-Syringe Adapter	183
1045339	Loctite® Cartridge-Needle Adapter	183
1046901	Loctite® High Pressure 300 ml Benchtop Cartridge Dispenser	28, 49, 80, 88, 113, 174
1049138	Loctite® High Pressure Dispense Valve – 50 Bar	28, 80, 88, 113, 175
1051330	Loctite® 3034™ Structural Adhesive	46, 48
1051591	Loctite® 3032™ Structural Adhesive	46, 48
1053262	Loctite® Mix Nozzle	185
1055263	Loctite® H8610™ Speedbonder™ Structural Adhesive	36, 37
1055839	Loctite® H8610™ Speedbonder™ Structural Adhesive	36, 37
1056929	Loctite® H8010™ Speedbonder™ Structural Adhesive	36, 37
1056941	Loctite® H4710™ Speedbonder™ Structural Adhesive	35, 37
1056942	Loctite® H8100™ Speedbonder™ Structural Adhesive	36, 37
1056943	Loctite® H8100™ Speedbonder™ Structural Adhesive	36, 37
1057673	Loctite® 331™ Structural Adhesive	31, 33
1057674	Loctite® 331™ Structural Adhesive	31, 33
1062124	Loctite® 331™ Structural Adhesive	31, 33
1064166	Loctite® H8700™ Speedbonder™ Structural Adhesive	35, 37
1064321	Loctite® H8700™ Speedbonder™ Structural Adhesive	35, 37
1069258	Loctite® 7088™ QuickStix® Primer	134, 139, 140, 146
1072198	Loctite® 3554™ Indigo® Visible Light Cure Adhesive	20, 22, 161, 162
1072199	Loctite® 3554™ Indigo® Visible Light Cure Adhesive	20, 22, 161, 162
1072200	Loctite® 3555™ Indigo® Visible Light Cure Adhesive	161, 162
1072220	Loctite® 3555™ Indigo® Visible Light Cure Adhesive	20, 22
1072221	Loctite® 3555™ Indigo® Visible Light Cure Adhesive	20, 22, 161, 162
1072222	Loctite® 3556™ Indigo® Visible Light Cure Adhesive	20, 22, 161, 162
1072223	Loctite® 3556™ Indigo® Visible Light Cure Adhesive	20, 22, 161, 162
1073344	Loctite® 5510™ Adhesive/Sealant	27, 28, 79, 80
1073346	Loctite® 5510™ Adhesive/Sealant	27, 28, 79, 80
1073347	Loctite® 5510™ Adhesive/Sealant	27, 28, 79, 80
1073348	Loctite® 5570™ Adhesive	27, 28, 79, 80
1073349	Loctite® 5570™ Adhesive	27, 28, 79, 80
1076341	Loctite® Cartridge Mix Nozzle	186
1077864	Loctite® E-50GW™ Hysol® Epoxy Adhesive	36, 37
1078234	Loctite® E-30UT™ Hysol® Epoxy Adhesive	40, 44
1078235	Loctite® E-30UT™ Hysol® Epoxy Adhesive	40, 44
1078249	Loctite® E-50GW™ Hysol® Epoxy Adhesive	36, 37
1078250	Loctite® E-220IC™ Hysol® Epoxy Adhesive	31, 33
1078261	Loctite® E-220IC™ Hysol® Epoxy Adhesive	31, 33
1078992	Loctite® E-119HP™ Hysol® Epoxy Adhesive	46, 47
1079593	Loctite® E-50CR™ Hysol® Epoxy Adhesive	42, 44
1079594	Loctite® E-50CR™ Hysol® Epoxy Adhesive	42, 44
1080008	Loctite® E-119HP™ Hysol® Epoxy Adhesive	46, 47
1083845	Loctite® 50 ml-F Tube Squeeze Dispenser	131, 155, 174
1084092	Loctite® Cartridge Mix Nozzle	186
1084093	Loctite® Cartridge Mix Nozzle	186
1084255	Loctite® Cartridge Mix Nozzle	186
1086065	Loctite® E-4OHT™ Hysol® Epoxy Adhesive	42, 44
1086081	Loctite® E-4OHT™ Hysol® Epoxy Adhesive	42, 44
1086598	Loctite® E-05MR™ Hysol® Epoxy Adhesive	43
1086599	Loctite® E-05MR™ Hysol® Epoxy Adhesive	39, 43
1086600	Loctite® E-05MR™ Hysol® Epoxy Adhesive	39, 43
1087602	Loctite® E-05MR™ Hysol® Epoxy Adhesive	39, 43
1087603	Loctite® E-05MR™ Hysol® Epoxy Adhesive	39, 43
1087985	Loctite® 3060™ Structural Adhesive	31, 33
1087986	Loctite® 3060™ Structural Adhesive	31, 33
1087987	Loctite® 3060™ Structural Adhesive	31, 33
1087988	Loctite® 3060™ Structural Adhesive	31, 33
1088035	Loctite® 3060™ Structural Adhesive	31, 33
1091892	Loctite® 5590™ Adhesive	28, 80
1091893	Loctite® 5590™ Adhesive	28, 80
1091896	Loctite® 5590™ Adhesive	27, 28, 79, 80
1093940	Loctite® Heavy Duty Manual Cartridge Applicator	69, 87, 174
1093981	Loctite® Heavy Duty Manual Cartridge Applicator	69, 174
1100962	Loctite® Single-Axis Cartridge Mix Nozzle	186
1100963	Loctite® Single-Axis Cartridge Mix Nozzle	186
1107651	Loctite® H8510™ Speedbonder™ Structural Adhesive	36, 37
1108757	Loctite® Fixmaster® Anchor Bolt Grout and Anchor Bolt Grout HP	64, 69, 71
1108758	Loctite® Fixmaster® Anchor Bolt Grout and Anchor Bolt Grout HP	64, 69, 71
1108885	Loctite® Fixmaster® Anchor Bolt Grout and Anchor Bolt Grout HP	69, 71
1108886	Loctite® Fixmaster® Crack Filler NS	64, 70, 71
1112888	Loctite® 5604™ Silicone Sealant	81, 85
1113131	Loctite® Focused UV Flood Curing System	25, 167, 173
1116241	Loctite® Mix Nozzle	185
1117828	Loctite® Nordbak® Fast Cure Pneu-Wear	53, 57, 59
1130329	Loctite® Stepped Tip Mix Nozzle	186
1130330	Loctite® Stepped Tip Mix Nozzle	186
1131756	Loctite® 5451™ Thread Sealant	151, 153
1134601	Loctite® 2422™ Threadlocker	142, 145, 147
1134602	Loctite® 2422™ Threadlocker	142, 145, 147
1134607	Loctite® 2047™ Threadlocker	145, 148
1134871	Loctite® 2423™ Threadlocker	145, 147
1135732	Loctite® 3974™ Light Cure Adhesive	21, 22, 161, 162
1135733	Loctite® 3974™ Light Cure Adhesive	21, 22, 161, 162

PRODUCT & ITEM NO.	PRODUCT DESCRIPTION	PAGE NUMBER	PRODUCT & ITEM NO.	PRODUCT DESCRIPTION	PAGE NUMBER
1138258	Loctite® 5604™ Silicone Sealant	81, 85	1256848	Loctite® Stainless Steel Tips Helical Thread	182
1138281	Loctite® 5770™ Thread Sealant	150, 151, 153	1257475	Loctite® 5625™ Silicone Potting Compound	111, 112
1138282	Loctite® 2620™ Threadlocker	142, 145, 148	1257478	Loctite® 5620™ Silicone Potting Compound	81, 86, 111, 112
1138284	Loctite® 5770™ Thread Sealant	150, 151, 153	1257593	Loctite® 5620™ Silicone Potting Compound	81, 86, 111, 112
1143355	Loctite® Mix Nozzle with Integral Needle Adapter	185	1257594	Loctite® 5620™ Silicone Potting Compound	81, 86, 111, 112
1145743	Loctite® Mix Nozzle with Integral Needle Adapter	185	1257595	Loctite® 5620™ Silicone Potting Compound	81, 86, 111, 112
1145744	Loctite® Mix Nozzle	186	1257596	Loctite® 5620™ Silicone Potting Compound	81, 86, 111, 112
1146078	Loctite® Dispense Tip	183	1257597	Loctite® 5620™ Silicone Potting Compound	81, 86, 111, 112
1146079	Loctite® Dispense Tip	183	1257607	Loctite® 5623™ Silicone Potting Compound	111, 112
1147763	Loctite® Cartridge-Dispense Valve Adapter Assembly	183	1257609	Loctite® 5623™ Silicone Potting Compound	111, 112
1153502	Loctite® High Pressure Dispense Valve – 150 Bar	28, 80, 88, 113, 175	1257611	Loctite® 5623™ Silicone Potting Compound	111, 112
1158514	Loctite® Head Bolt & Water Jacket Sealant	150, 151, 153	1257612	Loctite® 5623™ Silicone Potting Compound	111, 112
1162399	Loctite® Tile Bond Red, High Temp RTV Silicone Adhesive Sealant	83, 84	1257613	Loctite® 5625™ Silicone Potting Compound	111, 112
1165866	Loctite® Superflex® RTV Silicone Adhesive Sealant Equipment Green	83, 84, 87	1257615	Loctite® 5625™ Silicone Potting Compound	111, 112
1165867	Loctite® Superflex® RTV Silicone Adhesive Sealant Construction Yellow	83, 84, 87	1257616	Loctite® 5625™ Silicone Potting Compound	111, 112
1166733	Loctite® 3364™ Hysol® Urethane Adhesives	107	1257617	Loctite® 5625™ Silicone Potting Compound	111, 112
1167237	Loctite® Food Grade Anti-Seize	92, 94, 95	1259190	Loctite® Round Mix Nozzle	185
1167582	Loctite® LED Flood Array – 375	26, 168, 173	1259300	Loctite® 5623™ Silicone Potting Compound	111, 112
1167589	Loctite® LED Flood Array – Indigo®	26, 168, 173	1265282	Loctite® UV-V Dosimeter-Radiometer	25, 167, 173
1167593	Loctite® LED Flood Array – 405	26, 168, 173	1265761	Loctite® Thread Sealant for Oxygen Compatible Systems	150, 153, 154
1169241	Loctite® Food Grade Anti-Seize	92, 94, 95	1265769	Loctite® 5452™ Fast Cure Thread Sealant	150, 152, 154
1170163	Loctite® Food Grade Anti-Seize	92, 94, 95	1265770	Loctite® 5452™ Fast Cure Thread Sealant	150, 152, 154
1174633	Loctite® Electrical Contact Cleaner	133, 135, 137	1266142	Loctite® Superflex® RTV Silicone Adhesive Sealant	83, 84
1176431	Loctite® Clear Manual Syringe Kit	184	1271651	Loctite® Cartridge Preheater	90
1176432	Loctite® Clear Manual Syringe Kit	184	1276167	Loctite® QuickStix® 5671™ PST™ Pipe Sealant	150, 152, 154
1180632	Loctite® CureJet™ Quad Controller	26, 168, 173	1289249	Loctite® Trailer Jack Stand Grease	91, 97, 100
1180633	Loctite® Clear Manual Syringe Kit	184	1291112	Loctite® 5th Wheel Grease	91, 97, 100
1180634	Loctite® Clear Manual Syringe Kit	184	1291113	Loctite® Fixmaster® Crack Filler SL	64, 70, 71
1186840	Loctite® 2046™ Threadlocker	144, 147	1294304	Loctite® Pneumatic Handheld 300 ml Dispenser	12, 24, 28, 49, 78, 80, 88, 90, 113, 174
1194276	Loctite® 5510™ Adhesive/Sealant	27, 28, 79, 80	1296594	Loctite® H4720™ Speedbonder™ Structural Adhesive	35, 37
1194277	Loctite® 5510™ Adhesive/Sealant	27, 28, 79, 80	1311327	Loctite® SpeedSeal™ Silicone Sealant	83, 84
1197372	Loctite® 5570™ Adhesive	27, 28, 79, 80	1312042	Loctite® SpeedSeal™ Silicone Sealant	83, 84
1197374	Loctite® 5510™ Adhesive/Sealant	27, 28, 79, 80	1313319	Loctite® 5802™ Thread Sealant	150, 152, 154
1197375	Loctite® 5570™ Adhesive	27, 28, 79, 80	1317148	Loctite® 5203™ Flange Sealant	75, 77
1212164	Loctite® Insulating & Sealing Wrap	157, 158	1317781	Loctite® Chisel® MC-Free Paint Stripper	133, 136, 137
1212165	Loctite® 5050™ Fastgasket® Silicone Adhesive Sealant	20, 21, 82, 87	1321706	Loctite® 3092™ Instant Adhesive	7, 10
1212166	Loctite® 5050™ Fastgasket® Silicone Adhesive Sealant	20, 21, 82, 87	1323940	Loctite® Nordbak® Wearing Compound	53, 57, 59
1212167	Loctite® 5055™ Silicone Adhesive Sealant	20, 21, 111, 112, 165, 166	1324008	Loctite® Nordbak® Wearing Compound	53, 57, 59
1214246	Loctite® 5055™ Silicone Adhesive Sealant	20, 21, 111, 112, 165, 166	1324134	Loctite® Fixmaster® Fast Set Grout	64, 69, 71
1214247	Loctite® 5055™ Silicone Adhesive Sealant	20, 21, 111, 112, 165, 166	1324544	Loctite® Ceramic Tile Adhesive	54, 58, 59
1214248	Loctite® 5056™ Silicone Adhesive Sealant	20, 21, 111, 112, 165, 166	1324571	Loctite® Nordbak® Combo Bead Wearing Compound	53, 57, 59
1214249	Loctite® 5056™ Silicone Adhesive Sealant	20, 21, 111, 112, 165, 166	1327836	Loctite® Nordbak® High Impact Wearing Compound	54, 58, 59
1214250	Loctite® 5056™ Silicone Adhesive Sealant	20, 21, 111, 112, 165, 166	1328352	Loctite® D-Series Benchtop Robot Station	177
1215342	Loctite® E-910™ Epoxy Adhesive	46, 47	1329221	Loctite® Zeta® 760A UV Wand System	168, 173
1215379	Loctite® E-7570™ Epoxy Adhesive	41, 44	1329467	Loctite® 243™ Blue Threadlocker	142, 144, 147
1215380	Loctite® E-7570™ Epoxy Adhesive	41, 44	1329505	Loctite® 243™ Blue Threadlocker	142, 144, 147
1219191	Loctite® E-910™ Epoxy Adhesive	46, 47	1329837	Loctite® 243™ Blue Threadlocker	142, 144, 147
1228790	Loctite® Stepped Tip Mix Nozzle	186	1330255	Loctite® 243™ Blue Threadlocker	142, 144, 147
1233798	Loctite® Replacement Plunger	10, 174	1330333	Loctite® 243™ Blue Threadlocker	142, 144, 147
1233800	Loctite® Gel CA Syringe Dispenser	10, 174	1330334	Loctite® 263™ Red Threadlocker	142, 144, 147
1241543	Loctite® UV Benchtop Conveyor	25, 167, 173	1330335	Loctite® 263™ Red Threadlocker	142, 144, 147
1241991	Loctite® 5188™ Flexible Flange Sealant	75, 77	1330582	Loctite® 263™ Red Threadlocker	142, 144, 147
1248606	Loctite® Spray Tip Mix Nozzle	186	1330583	Loctite® 263™ Red Threadlocker	142, 144, 147
1250154	Loctite® 5606™ Silicone Adhesive/Sealants	81, 85	1330585	Loctite® 263™ Red Threadlocker	142, 144, 147
1250155	Loctite® 5605™ Silicone Adhesive/Sealants	81, 85	1337712	Loctite® 454™ Prism® Instant Adhesive	9
1250156	Loctite® 5606™ Silicone Adhesive/Sealants	81, 85	1352349	Loctite® Big Foot® Flexible Low Profile Exterior Grade	62, 65, 66
1250755	Loctite® 5606™ Silicone Adhesive/Sealants	81, 85	1354766	Loctite® Big Foot® Flexible Low Profile Exterior Grade	62, 65, 66
1250756	Loctite® 5607™ Silicone Adhesive/Sealants	81, 85	1354770	Loctite® 7951™ Prism® Primer	134, 139, 140
1250757	Loctite® 5607™ Silicone Adhesive/Sealants	81, 85	1359255	Loctite® LED Flood Controller	26, 168, 168
1250758	Loctite® 5605™ Silicone Adhesive/Sealants	81, 85	1364033	Loctite® Single CureJet™ Controller	26, 168, 173
1251677	Loctite® 5605™ Silicone Adhesive/Sealants	81, 85	1369537	Loctite® CureJet™ Indigo® LED	26, 168, 173
1252929	Loctite® 5607™ Silicone Adhesive/Sealants	81, 85	1369538	Loctite® CureJet™ 405 LED	26, 168, 173
1253201	Loctite® 5600™ Series – Part A, 3.5 gallon	81, 85	1369539	Loctite® CureJet™ 375 LED	26, 168
1253202	Loctite® 5600™ Series – Part A, 575 lb.	81, 85	1370891	Terostat® 9000 PL HMLC Direct Glazing Adhesive	89, 90
1253203	Loctite® 5188™ Flexible Flange Sealant	75, 77	1371250	Terostat® 8599 Direct Glazing Adhesive	89, 90
1253206	Loctite® 5613™ Silicone	81, 85	1371355	Loctite® H8110™ Speedbonder™ Structural Adhesive	36, 37
1253207	Loctite® 5613™ Silicone	81, 85	1371361	Loctite® H8110™ Speedbonder™ Structural Adhesive	36, 37
1253208	Loctite® 5613™ Silicone	81, 85	1372603	Loctite® QuickTape® 249™	142, 144, 147
1253211	Loctite® 5613™ Silicone	81, 85	1372751	Loctite® Universal Fixmaster® Dispenser	34, 38, 50, 119, 120, 174
1253212	Loctite® 5613™ Silicone	81, 85	1373425	Loctite® 1C™ Hysol® Epoxy Adhesive	42, 44
1254143	Loctite® A-533™ Structural Adhesive	39	1376969	Loctite® 4204™ Prism® Instant Adhesive	8, 9
1254144	Loctite® A-533™ Structural Adhesive	39, 43	1376970	Loctite® 4203™ Prism® Instant Adhesive	8, 9
1254145	Loctite® A-533™ Structural Adhesive	39, 43	1377200	Loctite® 100W Wand System	26, 168, 173
1254434	Loctite® A-534R™ Activator	134, 139, 140	1377344	Loctite® 1C™ Hysol® Epoxy Adhesive	42, 44
1254435	Loctite® A-534R™ Activator	134, 139, 140	1377390	Terostat® 8599 Direct Glazing Adhesive	89, 90
1255058	Loctite® Stainless Steel Tips Helical Thread	182	1377391	Loctite® 1C™ Hysol® Epoxy Adhesive	42, 44
1255059	Loctite® Stainless Steel Tips Helical Thread	182	1377641	Terostat® 9096 PL Direct Glazing Adhesive	89, 90
1255702	Loctite® A-6750™ Structural Adhesive	32, 33	1377642	Terostat® 8597 PL HMLC Direct Glazing Adhesive	89, 90
1255708	Loctite® A-671™ Structural Adhesive	32, 33	1377643	Terostat® 8599 Direct Glazing Adhesive	89, 90
1255709	Loctite® A-671™ Structural Adhesive	32, 33	1377650	Loctite® 1C™ Hysol® Epoxy Adhesive	42
1256398	Loctite® 331™ Structural Adhesive	31, 33	1377777	Loctite® 1C™ Hysol® Epoxy Adhesive	42, 44
1256488	Loctite® A-671™ Structural Adhesive	32, 33	1384596	Loctite® H5004™ Speedbonder™ Structural Adhesive	45, 48
1256489	Loctite® A-671™ Structural Adhesive	32, 33	1385991	Loctite® 5611F™ Silicone Potting Compound	111, 112
1256497	Loctite® Stainless Steel Tips Helical Thread	182	1386228	Loctite® E-7570™ Epoxy Adhesive	41, 44
1256501	Loctite® A-671™ Structural Adhesive	32, 33	1386373	Loctite® 5611™ Silicone Potting Compound	111, 112
1256502	Loctite® A-671™ Structural Adhesive	32, 33	1386378	Loctite® 5611S™ Silicone Potting Compound	111, 112
1256503	Loctite® A-6750™ Structural Adhesive	32, 33	1387212	Loctite® 5611S™ Silicone Potting Compound	111, 112
1256506	Loctite® A-6750™ Structural Adhesive	32, 33	1387706	Loctite® 5611F™ Silicone Potting Compound	111, 112

INDEX BY ITEM NUMBER

INDEX

Index by Item Number

PRODUCT & ITEM NO.	PRODUCT DESCRIPTION	PAGE NUMBER
1387908	Loctite® 5611™ Silicone Potting Compound	111, 112
1388496	Loctite® 5611S™ Silicone Potting Compound	111, 112
1390321	Loctite® Integrated Semiautomatic Dispenser	12, 24, 131, 155, 170, 173
1390322	Loctite® Integrated Semiautomatic Dispenser	12, 24, 131, 155, 170, 173
1390323	Loctite® UV-BA Dosimeter-Radiometer	25, 167, 173
1401789	Loctite® 4311™ Flashcure® Light Cure Adhesive	8, 9, 19, 21, 163, 164
1401790	Loctite® 4310™ Flashcure® Light Cure Adhesive	8, 9, 19, 21, 163, 164
1401791	Loctite® 4311™ Flashcure® Light Cure Adhesive	8, 9, 19, 21, 163, 164
1401792	Loctite® 4310™ Flashcure® Light Cure Adhesive	8, 9, 19, 21, 163, 164
1402562	Loctite® 3979™ Light Cure Adhesive	21, 22, 161, 162
1402563	Loctite® 3979™ Light Cure Adhesive	21, 22, 161, 162
1405182	Loctite® Square Mix Nozzle	185
1406023	Loctite® Spray Valve Digital Controller	11, 173
1406024	Loctite® UV Spot-7020 Radiometer	25, 167, 173
1418664	Terostat® 8519 P Primer/Activator	89, 90
1418666	Terostat® 8519 P Primer/Activator	89, 90
1418667	Terostat® 8517 H Glass Primer	89, 90
1418668	Terostat® 8521 Painted Substrate Primer	89, 90
1427231	Loctite® 7700 LED Light Source II	26, 168, 173
1427232	Loctite® 7700-HD LED Light Source II	26, 168, 173
1430053	Terostat® 9000 PL HMLC Direct Glazing Adhesive	89, 90
1432213	Loctite® 5611F™ Silicone Potting Compound	111, 112
1452395	D-Series 300 Benchtop Robot Station	177
1452396	D-Series 400 Benchtop Robot Station	177
1496756	Loctite® Insulating & Sealing Wrap	157, 158
1511184	Loctite® E-40EXP™ Hysol® Epoxy Adhesive	107
1511653	Loctite® E-40EXP™ Hysol® Epoxy Adhesive	107
1511896	Loctite® E-40EXP™ Hysol® Epoxy Adhesive	107
1511897	Loctite® E-40EXP™ Hysol® Epoxy Adhesive	107
1526121	Loctite® 2400NA™ Blue Threadlocker	144, 147

PRODUCT & ITEM NO.	PRODUCT DESCRIPTION	PAGE NUMBER
1526123	Loctite® 2700NA™ Red Threadlocker	145, 148
1526565	Loctite® 2700NA™ Red Threadlocker	145, 148
1626122	Loctite® 2400NA™ Blue Threadlocker	144, 147
1385991	Loctite® 5611F™ Silicone Potting Compound	113, 114
1386228	Loctite® E-7570™ Epoxy Adhesive	41, 44
1386373	Loctite® 5611™ Silicone Potting Compound	113, 114
1386378	Loctite® 5611S™ Silicone Potting Compound	113, 114
1387212	Loctite® 5611S™ Silicone Potting Compound	113, 114
1387706	Loctite® 5611F™ Silicone Potting Compound	113, 114
1387908	Loctite® 5611™ Silicone Potting Compound	113, 114
1388496	Loctite® 5611S™ Silicone Potting Compound	113, 114
1390321	Loctite® Integrated Semiautomatic Dispenser	12, 24, 133, 157, 172, 175
1390322	Loctite® Integrated Semiautomatic Dispenser	12, 24, 133, 157, 172, 175
1390323	Loctite® UV-BA Dosimeter-Radiometer	25, 169, 175
1401789	Loctite® 4311™ Flashcure® Light Cure Adhesive	8, 9, 19, 21, 165, 166
1401790	Loctite® 4310™ Flashcure® Light Cure Adhesive	8, 9, 19, 21, 165, 166
1401791	Loctite® 4311™ Flashcure® Light Cure Adhesive	8, 9, 19, 21, 165, 166
1401792	Loctite® 4310™ Flashcure® Light Cure Adhesive	8, 9, 19, 21, 165, 166
1402562	Loctite® 3979™ Light Cure Adhesive	21, 22, 163, 164
1402563	Loctite® 3979™ Light Cure Adhesive	21, 22, 163, 164
1405182	Loctite® Square Mix Nozzle	187
1406023	Loctite® Spray Valve Digital Controller	11, 175
1406024	Loctite® UV Spot-7020 Radiometer	25, 169, 175
1418664	Terostat® 8519 P Primer/Activator	91, 92
1418666	Terostat® 8519 P Primer/Activator	91, 92
1418667	Terostat® 8517 H Glass Primer	91, 92
1418668	Terostat® 8521 Painted Substrate Primer	91, 92
1427231	Loctite® 7700 LED Light Source II	26, 170, 175
1427232	Loctite® 7700-HD LED Light Source II	26, 170, 175
1432213	Loctite® 5611F™ Silicone Potting Compound	113, 114

THE PROBLEM SOLVER

A Quick Reference Guide to the Most Common Maintenance Problems

PROBLEM	SOLUTION
Rust, corrosion, galling, or seizing on metal threaded and unthreaded assemblies	Anti-Seize Compounds
Slippery pedestrian/vehicular areas	Anti-Slip Coatings
Damaged conveyor belts	Belt Repair/Urethanes
Fastening and joining	Bonding – Acrylic, Cyanoacrylate, Epoxy & Urethane, Hot Melt
Worn surfaces/damaged parts	Epoxies
Cracked floors, restoring old concrete, bonding to concrete/set anchor bolts, mount equipment	Flooring & Grout
Leaks – gasket, oil, transmission, coolant	Gasketing & Sealing
Friction, heat, or wear between solid metal surfaces	Lubricants
Backlash, key wallowing, spun bearings, shaft alignment, wear	Retaining Compounds
Vibrational loosening	Threadlocking
Leaks – air, hydraulic, fouled valves	Thread Sealing
Worn or corroded surfaces – material handling equipment	Wearing Compounds

THE ADHESIVE SOURCEBOOK

2011 VOLUME 11



Your Source for
**LOCTITE® PRODUCTS FOR DESIGN, ASSEMBLY,
 MANUFACTURING AND MAINTENANCE**

Visit us on the web at

www.henkelna.com/loctite
 for immediate access to:

- Distributor Information
- Material Safety Data Sheets
- Technical Data Sheets
- Product Application Assistance
- Literature and our NEW e-Catalog

Loctite® is the preferred choice for high performance adhesive and sealant solutions for industrial manufacturing and maintenance.



Henkel Corporation
 Engineering Adhesives
 One Henkel Way
 Rocky Hill, CT 06067
 U.S.A.
www.henkelna.com/industrial
www.henkelna.com/loctite

U.S.A.

For your local Loctite® Adhesives and Sealants Specialist, the nearest authorized Loctite® products distributor, to place an order, to arrange an in-plant seminar or for technical product assistance, call: 1-800-LOCTITE (562-8483).

HENKEL CORPORATION
 Engineering Adhesives
 One Henkel Way
 Rocky Hill, Connecticut 06067
 Tel: 860-571-5100
 Fax: 860-571-5465
www.henkelna.com/industrial
www.henkelna.com/loctite

CANADA

For your local Loctite® Adhesives and Sealants Specialist, for your nearest authorized Loctite® products distributor, to place an order, to arrange an in-plant seminar, or for technical product assistance, call: 1-800-263-5043 (within Canada).

HENKEL CANADA CORPORATION
 2225 Meadowpine Blvd.
 Mississauga, Ontario, Canada L5N 7P2
 Tel: 1-800-263-5043 (within Canada)
 Tel: 905-814-6511
 Fax: 905-814-5391

MEXICO & CENTRAL AMERICA

For your local Loctite® Adhesives and Sealants Specialist, for your nearest authorized Loctite® products distributor, to place an order, to arrange an in-plant seminar or for technical product assistance, call: 01-800-436-5357 (within Mexico); 506-256-6667 (within Costa Rica).

HENKEL CAPITAL S.A. DE C.V. (MEXICO)
 Boulevard Magnocentro No. 8 Piso 2
 Centro Urbano Interlomas
 52760 Huixquilucan, Estado de Mexico
 Technical Product Assistance: Tel: 52-55-3300-3669
 To place an order: Tel: 52-55-3300-3644
 Fax: 52-55-3300-3019
www.loctite.com.mx

HENKEL COSTA RICA LTDA.
 De la Lovable, 100m Sur/50m Oeste
 San Joaquín de Flores
 Heredia, Costa Rica
 Tel: 506-256-6667 (within Costa Rica)
 Tel: 506-277-4800
 Fax: 506-277-4883
www.loctite.com.mx

SOUTH AMERICA

For your local Loctite® Adhesives and Sealants Specialist, for your nearest authorized Loctite® products distributor, to place an order, to arrange an in-plant seminar, or for technical product assistance, contact:

HENKEL LTDA. (BRAZIL)
 Rua Karl Huller, 136 -
 Jd. Canhema, Diadema
 São Paulo, Brazil
 Tel: 0800-704-2334 (within Brazil)
 Tel: 55-11-3205-8955
 Fax: 55-11-3205-8887
www.loctite.com.br

HENKEL ARGENTINA S.A.
 Tte. Cnel. Magán 1990 - Sarandi
 (B1872HRN) Avellaneda
 Buenos Aires, Argentina
 Tel: 0800-333-0213 (within Argentina)
 Tel: 54-11-4001-0100
 Fax: 54-11-4205-3442
www.loctite.com.ar

HENKEL CHILE LTDA.
 Av. Laguna Sur 9551
 Pudahuel
 Santiago, Chile: C.P. 9060987
 Tel: 800-223005 (within Chile)
 Tel: 56-2-381-7200
 Fax: 56-2-381-7811
www.loctite.cl

HENKEL COLOMBIANA S.A.
 Calle 17 No. 68-B-73
 Bogotá D.C., Colombia
 Tel: 01800-0114173 (within Colombia)
 Tel: 571-423 9000
 Fax: 571-425-1331
www.loctite.com.co

HENKEL VENEZOLANA S.A.
 Zona Industrial Pruinca
 Calle 2 Parcela 31 y 32
 Guacara - Edo Carabobo, Venezuela
 Tel: 0800-1007714 (within Venezuela)
 Tel: 5824-5560-2611
 Fax: 5824-5560-2660
www.loctite.com.ve